

# PCBE

**PLAIN COMMUNITIES BUSINESS EXCHANGE**

**DEVELOPING EMPLOYEE  
COMPENSATION AND  
BENEFITS**

By Anabaptist Financial – page 38

**MAKE 2022 A GREAT YEAR  
FOR YOUR BUSINESS**

By Don Tyler – page 62

**HIGH STEEL BRIDGE**

By Candace Brown – page 74

**CHRISTMAS APOLOGETICS**

By Thomas Bauman – page 124



**A THREE-YEAR PROJECT  
PRESSURES A STEAM ENTHUSIAST**

Article on page 16

**DECEMBER 2021**

Volume 28, No. 12

# Makita

# BARE TOOL SAVINGS! SALE ENDS DEC 31<sup>ST</sup>

## Buy 2 Bare Tools: ➤ Get \$50.00 Instant Rebate

### XDT16Z

18V LXT® Lithium-Ion Brushless Cordless Quick Shift Mode™ 4 Speed Impact Driver, Tool Only



Price **\$179.00**

### XDT14Z

18V LXT® Lithium-Ion Brushless Cordless Quick-Shift Mode™ 3-Speed Impact Driver, Tool Only



Price **\$149.00**

### XDT13Z

18V LXT® Lithium-Ion Brushless Cordless Impact Driver, Tool Only



Price **\$129.00**

### XPH14Z

18V LXT® Lithium-Ion Brushless Cordless 1/2" Hammer Driver-Drill (Tool Only)



Price **\$149.00**

### XPH07Z

18V LXT® Lithium-Ion Brushless Cordless 1/2" Hammer Driver-Drill, Tool Only



Price **\$139.00**

### XPH12Z

18V LXT® Lithium-Ion Compact Brushless Cordless 1/2" Hammer Driver Drill, Tool Only



Price **\$129.00**

### XTR01Z

18V LXT® Lithium-Ion Compact Brushless Cordless Router, Tool Only



Price **\$129.00**

### XSF03Z

18V LXT® Lithium-Ion Brushless Cordless 4,000 RPM Drywall Screwdriver, Tool Only



Price **\$159.00**

### XMT03Z

18V LXT® Lithium-Ion Cordless Multi Tool, Tool Only



Price **\$119.00**

### XAG04Z

18V LXT® Lithium-Ion Brushless Cordless 4-1/2" / 5" Cut-Off/Angle Grinder, Tool Only



Price **\$139.00**

### XAG25Z

18V LXT® Lithium-Ion Brushless Cordless 4 1/2" / 5" X LOCK Angle Grinder, with AFT®, Tool Only



Price **\$149.00**

### XVJ03Z

18V LXT® Lithium-Ion Cordless Jig Saw, Tool Only



Price **\$159.00**

### XRW01Z

18V LXT® Lithium-Ion Cordless 3/8" / 1/4" Sq. Drive Ratchet, Tool Only



Price **\$159.00**

### XRJ05Z

18V LXT® Lithium-Ion Brushless Cordless Recipro Saw, Tool Only



Price **\$199.00**

### XOB01Z

18V LXT® Lithium-Ion Cordless 5" Random Orbit Sander, Tool Only



Price **\$119.00**

### XBU03Z

18V LXT® Lithium-Ion Brushless Cordless Blower, Tool Only



Price **\$129.00**

### DMP180ZX

18V LXT® Lithium-Ion Cordless Inflator, Tool Only



Price **\$119.00**

### XSH03Z

18V LXT® Lithium-Ion Brushless Cordless 6-1/2" Circular Saw, Tool Only



Price **\$199.00**

**Yoder**  
SERVICE & SUPPLY  
Construction Tools & Fasteners

9381 Winesburg Road • Dundee, OH 44624

330.359.2300 Phone | 330.359.7107 Fax

Mon. – Thurs. 5:00 AM – 5:30 PM

Fri. 5:00 AM – 5:00 PM

Sat. 7:00 AM – 11:30 AM

Buy 3 Bare Tools:  
➤ Get \$50.00 OFF

Plus a BLI850B  
**FREE!**





# CAST IRON WELDING SIMPLIFIED

## ***SIMPLESTIK*** #905SP

905SP is the industry's most advanced, easy-to-use welding alloy for repairing iron castings. Strong, crack-free welds that are not possible with common nickel electrodes can be made easily by those with minimal welding skills.

905SP utilizes a unique core wire with high current carrying capacity to prevent the electrode from overheating. The engineered coating formulation produces a soft, stable arc that pulses on both AC and DC-polarity. The pulsing feature reduces heat build-up that causes castings to crack while being welded. No preheat or post-heat is required - saving you time and labor costs.

905SP can be used to weld all weldable castings including gray, gray alloys, ductile, meehanite, and nodular. It can also be used to join cast to steel, and cast to stainless. The resulting weld deposits are dense, machinable and threadable, with a higher tensile strength than most original castings.

To learn more about 905SP,  
call 717-874-2060

**Ecenrode Welding Supply LLC**  
P.O. Box 276 Lampeter, PA 17537  
717-874-2060 | [www.ecenrode.com](http://www.ecenrode.com)

***ECENRODE***  
**WELDING SUPPLY LLC**



# Editorials

Two extra special occurrences last month were the weddings of our younger siblings. Anna Mary and I each had a sister getting married in the month of November and all summer we eagerly looked forward to both events. A mixture of joyfulness and solemnity, weddings can provide much food for thought, not only to the bridal couple, but also to those of us who have been married for a number of years. At both weddings, we enjoyed fellowship with distant family members only seen several times a year, we listened to sermons that offered much marital counsel, and we sang songs of worship and praise to our Maker who instituted the holy union of man and wife. Congratulations Mel & Ada and Mark & Lydia! May the love you have for each other be a reflection of God's love for mankind.

This is the month that we observe the birth of the One who came to earth many years ago in the form of man so that we can claim the promise of everlasting life. Is it no wonder that the angels considered it "good tidings of great joy"? I feel it is appropriate to remind ourselves of those words throughout the year and not just at Christmas. I can imagine the birth of our Saviour was a much-anticipated event for the angels and they were eager to inform fallen mankind of the new hope that the birth of Jesus provided. The good tidings of great joy was not just for the shepherds, or for a certain nationality. Notice how the angels added, "which shall be unto *all* people." It was for you and me, and the entire world. Are we claiming the good tidings of great joy for our own?

When Mary and Joseph entered the small village of Bethlehem, the innkeeper and his family had the opportunity to provide hospitality to the long-awaited

Messiah. But they missed Him! They were too busy with the economic surge that was a result of the emperor's decree. Travelers from miles around were immigrating to their little town and the innkeepers were capitalizing on the increased revenue. Suddenly their quiet little inn had no vacancy, possibly for weeks on end. It is likely they considered this a God-given blessing to unexpectedly have so much increase in sales. They probably laid aside all other plans and gave their entire time and energy to their business. But it caused them to miss Jesus.

Even today, many businesses in our communities are extra busy this time of year because of the seasonal increase in consumer spending. According to a Gallup poll, Americans intend to spend an average of \$837 on gifts and holiday items this Christmas season. Retailers spend lots of marketing dollars this time of year, each trying to capture as much of the \$837 as possible. May we still slow down enough to realize and recognize the real reason we observe this holiday.

The innkeeper very likely missed Christ because of being busy with important work. Not because of evils such as drunkenness or idolatry, but simply because of the cares of this life. According to Luke 21:34 the cares of this life are a serious danger that could cause us too, to miss Christ when He comes to earth the second time.

Wishing each of you a wonderful Christmas season filled with peace and goodwill.

Ivan Lee Lapp — Editor

The colorful autumn leaves are now but a memory, signaling the conclusion of my favorite season. There were a few days that the autumn hues brimmed with vibrancy in the late afternoon sunshine. During a brief trip to Holmes County, Ohio, in late October, I was reminded how beautiful that corner of the world is during autumn. While the brilliant foliage nearly distracted me from my objective—interviewing several business owners—I didn't allow it to steal all my attention. Throughout my stay in Ohio, I met a fellow who recently began producing charcoal. Observing the process was quite intriguing.

Visiting the Behalt Amish and Mennonite Heritage Center recently was time well spent. I enjoyed learning more about the life of the early Anabaptists. Mark Oliver, senior tour guide at the Center, made history come alive during the thirty-

minute tour. It was so interesting, that I would like to return sometime. Marcus Yoder, executive director, also generously shared his time. Throughout our lively conversation, it became evident that he has gathered extensive knowledge of the early Anabaptists.

The end of another year is drawing near. I hope it was a good one for you; one that was filled with many opportunities to learn, grow, and engage in work and activities that help you achieve the Godly successes that you seek after. Wishing you all the best in the coming year, as well.

Leroy Martin — Contributor/Journalist

Another year of bountiful fall harvests, enabling us to fill our barns and cellars for winter nourishment.

We've had an exciting fall with preparing and hosting the wedding for our only daughter Ada Ruth and her fiancée Melvin Riehl. The wedding was held in the upstairs of the dairy barn on November 4th. They will be moving to their new rental home adjoining the farm here in the next month sometime.

You may have noticed that the Machinery Trader section of our magazine keeps growing larger. We hit a record high number of entries again for this month. Sales for used equipment seems to be in high demand as some manufacturers are struggling to keep production running at full capacity. If you are in need of equipment, see pages 280 thru 287 and see what our advertisers have to offer.

I've received a few calls from readers asking when their subscription expires. On the address label you can find your subscription expiration date typed next to your address. This is located on the outside of the plastic wrapper that your magazine arrives in.

I found the articles on celebrating Christmas very interesting. We printed *Christmas Apologetics* by Thomas Bauman on page 124 and *Why I am Unashamed of The Christmas Tradition* on page 166 by Anthony Hess. Both writers have expressed their views on celebrating the birth of Christ and gave a few pointers on why some of us confuse it with pagan celebration.

May your Christmas season be filled with joy and sharing and have a Happy New Year!

John Lapp — Advertising Sales Representative

On a frosty morning, cattle meander toward the barn, while corn shocks stand like sentries in the distance.

Source: Leroy Martin





# PCBE

PLAIN COMMUNITIES BUSINESS EXCHANGE

Our mission is to provide plain communities with Kingdom-focused business teachings and helpful connections through a monthly print magazine.

PO BOX 520  
Millersburg, PA 17061  
phone (717) 362-1118  
fax (717) 427-1600  
info@plaincommunities.com

Subscriptions - ext. 3  
fax (717) 842-6964  
subscriptions@plaincommunities.com

Advertising Sales - ext. 1  
Chris Lapp - ext. 103  
Daniel King, Jr. - ext. 113  
John Lapp - ext. 108  
Danny Esch - ext. 114  
advertise@plaincommunities.com

Machinery Trader & Classifieds - ext. 2  
John Lapp  
fax: (717) 427-1602  
mt@plaincommunities.com

Editor  
Ivan Lee Lapp - ext. 107  
editor@plaincommunities.com

Accounts Receivable/Payable  
Ivan Lapp - ext. 105  
ivan@plaincommunities.com

Contributor/Journalist  
Leroy Martin - ext. 106  
leroy@plaincommunities.com

Graphic Design Specialists  
Andrew Romberger  
Henry Beiler, Jr. - ext. 115

Publisher  
Raymond Lapp - ext. 104

Cover Image Credit: Paul Cyr



- 6 If This Bear Gets Me...  
*Mountain Meditations*
- 16 A Three-Year Project Pressures A Steam Enthusiast  
*Leroy Martin*
- 26 Creating the Right Culture  
*The DISconnected Workplace*
- 38 Developing Employee Compensation and Benefits  
*Anabaptist Financial*
- 50 The Right to Retire – Chapter 14  
*Going Till You're Gone*
- 62 Make 2022 A Great Year For Your Business  
*Don Tyler*
- 68-69 New Product Release
- 74 Record Breaking Relics of Northwest Logging History Survive at Dizzying Heights  
*Candace Brown*
- 86 The Annual PCBE Update: A Summary of Events That Transpired in 2021  
*Leroy Martin*
- 98 Who Do You Work For?  
*Getting Along at Work*
- 110 Meeting the Facilitator  
*Building a Legacy*
- 124 Christmas Apologetics  
*Thomas Bauman*
- 138 Warming the Home With Borntreger's True Heat Wood Bricks  
*Leroy Martin*
- 152 Waste Systems  
*Timber World*
- 166 Why I am Unashamed of the Christmas Tradition  
*Anthony Hess*
- 180 Job Costing — Now to Find the Time  
*Mind Your Business*
- 194 SALT Members Become Part of the Solution  
*CAM Salt Program*
- 195 Gary Miller Q&A
- 196 About Billboard Evangelism  
*Billboard Evangelism*
- 208 Chapter 9 and 10 (Part 5 of 7)  
*The Hand That Feeds You*
- 226 Producing Sweet Confections at Victorian Candy Company  
*Leroy Martin*
- 244 The Beginnings of a Humble Farm Implement; the ground driven manure spreader  
*Christopher Petrovich*
- 262 How to Build Your Annual Marketing Budget  
*Marketing 101*
- 265 Coffy Brake Answer
- 280-287 Machinery Trader
- 298 Step By Step: Sunset Equipment Produces an Affordable Horse Walker  
*Leroy Martin*
- 316 Zach's Potatoes  
*Boys in Business*
- 320-321 Classified Ads
- 334 Mišljenja i saveti o našoj farmi: Opinions and advice about our farm  
*Letters from Abroad*
- 352 Alaska's Sitka Blacktail Deer  
*Alaska Adventure Series*
- 370 Field Notes and Emerging Trends
- 373 Coffy Brake Riddle

SEE THE SUBSCRIPTION  
FORM ON PAGE 35

SEE THE ADVERTISERS INDEX  
ON PAGES 385-389

Postmaster and subscribers: Please send address changes to PCBE, PO BOX 520, MILLERSBURG, PA 17061. Plain Communities Business Exchange, a monthly business publication serving people in plain communities all over North America and Canada, is published at 165 Green Acre Dr., Millersburg, PA 17061. Periodicals class permit (024-125) at Millersburg, PA 17061 and other additional mailing offices. Copyright 2020 by Plain Communities Business Exchange. All rights reserved, including right to reproduce articles, advertising layouts, and designs prepared by our staff. No part of this publication may be reprinted or otherwise reproduced without written permission from the publisher. All magazine subscriptions are non-refundable unless other arrangements have been made with the publisher. Information in this publication is gathered from sources believed to be reliable, but the accuracy and completeness of the information cannot be guaranteed. Although every attempt is made to avoid mistakes by proofreading ad and story copy, the publisher cannot be responsible for errors resulting from printer's errors, omissions, or typos that may occur in this publication. Due to variations in paper size and header placement from month to month, ad proportions are accurate, but exact dimensions cannot be guaranteed. Acceptance of all stories and articles are subject to publisher's approval, and current columns/writers may be discontinued at any time at the discretion of the publisher. All content within any given article is the author's sole responsibility and liability, and PCBE will not be responsible for discrepancies, allegations, or controversies contained therein. Acceptance of all advertising is subject to publisher's approval and agreement by the advertiser to indemnify and protect the publishers from loss or expense on claims or suits based upon contents of such advertisement. Advertisements may be terminated at any time at the discretion of the publisher. PCBE discourages our advertisers from using pictures of people in their advertisements and will not accept any ads with pictures where the individual's dress code does not meet our approval. Publishers do not assume responsibility for errors in any advertisement beyond the cost of the space occupied by the individual item in which the error appeared.

# Mountain Meditations

RICHE LAUER

## If This Bear Gets Me, At Least I Won't Have To Be A Preacher

A recent fall afternoon found Gabriel Beachy and his faithful dog “Rusty” enjoying a tromp through the woods. A nice property come up for sale in our area. It lays land-joining to a parcel of woods and overgrown fields which “Gabe” and the Lauer boys already hunt. Gabe grew up alongside our boys, first in Abbeville and then here in Hillsville. He married my niece Natalie (Nad) Hershberger ten years ago, and they have a start on their string of children with Eleanor, Tobias, Truman, and Ramses. Although his children get opportunities to hike and hunt with their dad, Gabe chose to be alone with Rusty and his thoughts on this particular Thursday afternoon.

Gabe spotted movement farther along the wooded ridge. A large black bear came into his view and then disappeared. Seeing a bear is not uncommon here in Carroll County. I saw a small bear just a few weeks ago, crossing the road above our new house.

Gabe's intended path took him toward the bear. Black bears are, after all, nothing to be afraid of. Besides, Gabe had other things on his mind that afternoon. Rusty wandered away down the hollow and was soon lost from sight. Suddenly, Gabe heard Rusty barking excitedly. After a bit, the barks turned to yelps and began to rapidly draw closer. Within seconds, Rusty broke into sight, in full retreat up the hill. The large bear was in hot pursuit and (literally) right on Rusty's tail.

A dog is supposed to be a man's best friend, but loyalties get tested. Rusty bee-lined for Gabe, seeking rescue but bringing the angry bear with him. Gabe sized up the situation and abandoned dear Rusty to his fate. He turned and started up the nearest tree. The tree was only about eight inches in diameter and lacked handy branches, but it was available. Hugging and huffing, he climbed it in seconds and hung on for dear life.

Gabe climbed the tree in seconds out of pure necessity, for the angry bear had abandoned its pursuit of Rusty and was now (literally) nipping at Gabe's heels, jaws popping and snapping. Twice the bear went up the tree, and twice faithful Rusty returned to distract the bear. It slid down each time, chasing Rusty off and returning up the tree. On its third trip up the tree, the bear caught one of Gabe's Crocs in its snapping jaws. The bear bit thru the Croc, top and bottom, and into Gabe's foot. At this point, Gabe started thinking some thoughts. When the bear fell the third time, it pulled Gabe down as well. Man and bear landed side-by-side on the ground, up close and personal-like.

Rusty drew the bear aside once again. At that point, the bear may have been starting to tire of the fun. It stopped and held its distance. Gabe gathered up Rusty and made a slow but steady retreat. Gabe never saw any bear cubs, and he somehow neglected to physically examine the bear during the attack. But our assumption is that Rusty had made the mistake of harassing bear cubs and that an angry momma bear was the result. This commotion occurred on Thursday afternoon. At the evening church service the next day, we took the church voice for a double ordination. The call of God had been resting on Gabriel for some time. He felt the weight of these coming ordinations and later acknowledged

that he was not surprised to learn that he would be in the lot for minister. When he was in the tree on Thursday afternoon, Gabe said that the thought crossed his mind that “If this bear gets me, at least I won't have to be a preacher.”

On Saturday, the bishops interviewed those whose names given by the church. I serve as bishop here and told Gabe how I thought it would be. “When you were up in that tree, the bear was either going to let you go or she wasn't. It is the same for this call to the ministry. It is in God's hands. God is either going to let you go, or He isn't going to let you go.”

God didn't choose to let him go. On Sunday, three days after hugging a tree with a bear latched onto his foot, Gabe shared the lot for minister with his brother-in-law Jacob Miller. Gabe later described how he had decided in advance that he would take whatever hymn book was placed nearest to him. But, when he arose to do so, his hand passed over that nearest book and picked up the further one. It wasn't what Gabe had planned to do, but he suddenly felt that it was what he was supposed to do. When the hymn books were opened, Gabe's book contained the slip of paper reading: “The lot falleth into the lap, but the whole disposing thereof is of the LORD.”

It is a blessing to have younger men who are both qualified and willing to help lead the church. As conservative Anabaptists, we don't hire in preachers from far away to lead our churches. We follow the example set in Acts 6 and ask our congregations to “look ye out among you” for faithful men who can lead the church. If our churches are to have good leadership in the future, young men must choose to live faithful to God's commands and expectations. All the brethren in the church, along with their wives, should purpose in their hearts to follow God. All of us, not just ministers, should desire to meet the qualifications given in I Timothy 3 and Titus 1. Read them to remind yourself of how you ought to be living, whether or not you serve as a preacher. How disappointed God would be if only one or two people in a whole church met these qualifications!

Qualified men must also be *willing* men. It is always easier not to lead... to stay in the background...to expect someone else do the teaching...to allow someone else to set the good example for the youth. Serving in the ministry is a heavy responsibility, but it also carries rich blessings. If called by the church to serve as a minister or deacon, a faithful young man (and his wife) should be willing to trust God to enable them. God does not make mistakes, He has purposes beyond our understanding, and He strengthens those whom He calls.

I Peter 5: 1-4 *The elders which are among you I exhort, who am also an elder, and a witness of the sufferings of Christ, and also a partaker of the glory that shall be revealed: **Feed the flock** of God which is among you, taking the oversight thereof, **not by constraint, but willingly**; not for filthy lucre, but of a ready mind; Neither as being lords over God's heritage, but **being examples to the flock**. And **when the chief Shepherd shall appear, ye shall receive a crown of glory that fadeth not away.***



# YEAR END SAVINGS

## 7-1/4" 10-Pak Blade Special

DeWALT

#DWA171424B10 7-1/4" Circular Saw Blades (10 pk) ~~\$89.99~~ **\$81.99**

- 24 tooth carbide
- Come with Tough-Coat™ anti-stick coating to reduce friction and gumming
- Optimized for use on both corded and cordless circular saws

**Buy 3  
10-pks (30 blades)  
get 1 pk of 10  
FREE!**



## 20v Combo Kit Deal

DeWALT

#DCD996P2 20v Hammerdrill Kit ~~\$319.99~~ **\$299.99**

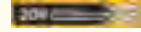

5 AH

**HOT  
BUY**

Includes: DCD996B Hammerdrill, (2) 5ah Batteries, Charger and Kit Box



**Buy Kit above and get  
your choice below FREE  
(up to \$150.00 value)**

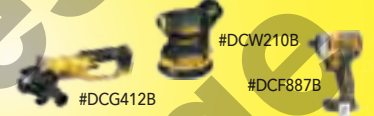

## 9" 6TPI Reciprocating Saw Blades

#20558 25-Pk ~~\$89.99~~ **\$79.99**

LENOX



**Buy (3) 25-pks and  
get (1) 25-pk FREE!**

## Reciprocating Saw Blade Set w/Storage Case

#12144 12-Piece Demolition Set ~~\$44.99~~ **\$29.99**

- Set includes: (3) 6" and (2) 9" 6 TPI nail embedded wood blades, (3) 6" and (2) 9" 14 TPI metal cutting blade and (2) 9" 10 TPI Fire and Rescue Blades

LENOX



## Speedbor Max Bits

IRWIN

#63831 6-Piece Set ~~\$41.99~~ **\$34.99**

Includes: 1/2", 5/8", 3/4", 7/8", 1", and 1-1/4" Speedbor Max Bits

**SAVE  
30%**



**Buy \$500.00 of any DeWalt, Irwin or Lenox Accessories  
and get \$150.00 off any DeWalt Tools or Batteries**

## Mini Utility Trike Trailer

#72821 ~~\$289.99~~ **\$259.99**

**Check out this  
nice little trailer!**

- 28" wide and 50" long, it will haul anything from flowers to rocks!
- Inside bed dimensions are 20" w x 35-3/4" L
- Only weighs 46 lbs.
- Comes complete with hitch pin attached to a chain and ramp tail gate
- Made in the USA

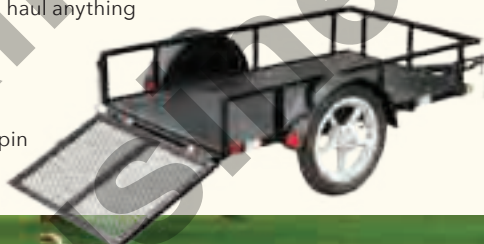

add \$25.00 oversize shipping rate

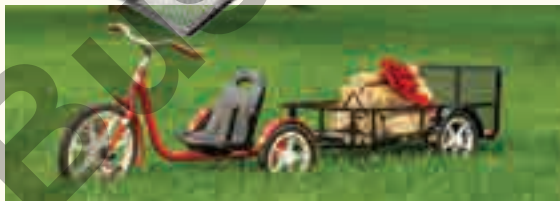

## DeWALT 68,000 BTU Propane Heater

DeWALT

#DXH70AV ~~\$199.99~~ **\$179.99**

Just plug any of the DeWalt 20v MAX batteries into the heater, hook up the included hose and regulator to a propane tank and you are ready to cut the cord and take this heater anywhere. 50% quieter than a standard propane heater. Heats up to 1,500 sq. ft.



## Milwaukee 7-1/4" Framing Circular Saw Blades

#48-41-0720 10-pack 24-tooth Carbide ~~\$87.90~~ **\$79.99**

- Anti-friction coating keeps the blade cool while cutting and resists corrosion and gumming
- Laser cutting technology creates the blade from 100% sheet steel to ensure a stable blade
- Laser cut vibration slots minimize wobble and warping
- Thin kerf design delivers faster cuts as well as more cuts per charge when using a cordless tool



**Buy (5) 10-pks (50 Blades) above and get Light below FREE!**

## Milwaukee Lighting

#2131-20 ~~\$219.95~~ **\$199.99**

- 2500 lumen max output
- 22 hr runtime on low (700 lumen) with 9ah battery, 14 hr on med (1100 lumen), 7 hr on high (2500 lumen) – Runtime with 5ah battery = L 12 hr, M 8 hr, H 4 hr.
- Dual Power: Powered by M18 or extension cord



**KEYSTONE**  
AIR POWER LLC

60 Elco Drive  
Myerstown, PA 17067

Phone: 717-866-9224 • Out of state: 866-866-9224

### Special hours during Sale week

December 6 - 11

Monday - 6:00 A.M. to 6:00 P.M.  
Tuesday - 6:00 A.M. to 8:00 P.M.  
Wednesday - 6:00 A.M. to 5:00 P.M.  
Thursday - 6:00 A.M. to 8:00 P.M.  
Friday - 6:00 A.M. to 6:00 P.M.  
Saturday - 7:00 A.M. - 3:00 P.M.

**FREE SHIPPING ON PREPAID ORDERS  
OVER \$370.00. FREE GIFTS WITH ORDERS  
OVER \$450.00.**

**Items on this ad may be ordered  
now thru December 11th.**



# D.A. HOCHSTETTLER & SONS LLP

**STEEL FABRICATORS • FARM IMPLEMENTS • LATHE & MILLWORK**

**NO HYDRAULICS NEEDED... SAVES YOU TONS OF STONE OR GRAVEL. NO NEED TO MESS WITH HYDRAULICS TO PROMOTE CROWN ON DRIVEWAY.**

## DEALERS FOR DRIVEWAY GRADERS CONTACT THE DEALER NEAREST YOU.

- All Around Building Supplies - Stratford, WI ..... 715-391-0215
- C Mar Welding - New Haven, IN ..... 260-410-8104
- Cedar Products - West Union, OH ..... 937-386-0086
- Choice Rental - Arthur, IL ..... 217-543-2022
- Crow Creek Enterprise - Toston, MT ..... 406-266-1114
- D&S Machine - Jamesport MO ..... 660-684-6949
- David Kurtz - Belleville, PA ..... 717-363-0530
- DJ General Repair - Dover, DE ..... 302-423-5690
- Ervin Beechy - Olney, IL ..... 618-843-3044
- Green Valley Harness - Centerville, MI ..... 269-476-4946
- Hilly Acres Woodshop - Loogootee, IN ..... 812-486-2522
- Ideal Welding - Middlebury, IN ..... 574-534-9304
- Joe's Engine Shop - Bremen, IN ..... 574-546-4413
- John Newswenger - Stanley, NY ..... 585-704-0687
- Legacy Manufacturing - Irvington, KY ..... 270-750-1050
- M.W. Repair - Millersburg, IN ..... 574-642-3556
- Miller's Repair - Nathalie, VA ..... 434-454-6326
- Pioneer General Store - Mio, MI ..... 989-826-3580
- Rays Repair - Topeka, IN ..... 260-593-2869
- Rising Sun Farms - Hopkinsville, KY ..... 270-886-1097
- Swiss Metal Spinings - Berne, IN ..... 260-216-0101
- United Fencing - Applecreek, OH ..... 330-857-1543
- Widespread Rental - Honeybrook, PA ..... 610-273-0269
- Yoder Equipment - Bloomfield, IA ..... 641-664-2797
- Yutzy Brothers Construction - Winterset, IA ..... 515-468-5524
- Zimmerman Farm Sales - Bethel, PA ..... 717-933-4114



**6' and 7' Sizes Available**

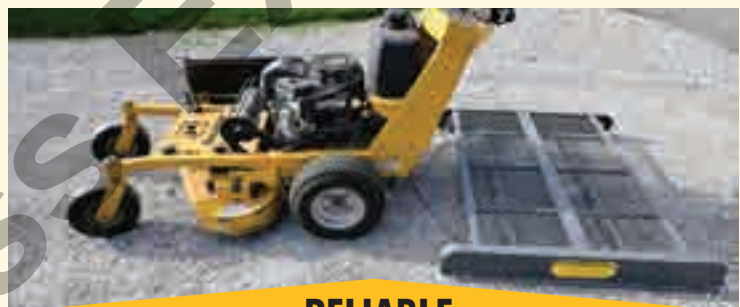

**RELIABLE**

### **4' MINI DRIVEWAY FINISHER GRADER**

Optional Snow Blade Available! Well gauged for your limestone driveway with minimal stone in your yard.

Excavators use for site prepping for buildings as well as concrete slabs.

- 4" Heavy Gauge Tube
- 6"W x 6'L AR235 Beveled Double Edge Grader Blade
- Blades are Adjustable Up & Down

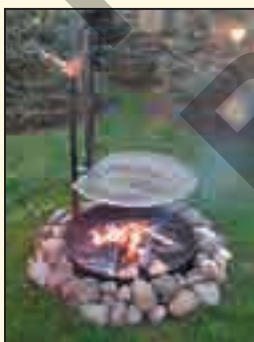

## The **NEW** Universal BBQ Campfire Grill

Get that over the fire, mouth watering, bold flavor you can't get from an oven.

*Built like an ox.*

Gather your family and friends to grill burgers, brats, and more, and make coffee or tea right over your campfire. Sturdy enough to support a stock pot. Large enough to fit 40 burgers.

**574-642-1144**

**RELIABLE**  
**DRIVEWAY FINISHER GRADER**

*Manufactured By:*  
**D.A. HOCHSTETTLER & SONS**  
4165 S. 500 W.  
Topeka, IN 46571  
574-642-1144

**SHIPPING AVAILABLE TO ALL STATES**



**Dream Designs**  
CUSTOM FRAMING

phone / fax: **717-490-0647**

sales@dreamdesignscustomframing.com

812 churchtown Rd. Narvon PA 17555

**CHRISTMAS SALE DAYS!**

10% off all books Dec. 8th - 11th

call-in or in-store!

Popularity has slain more prophets of God than persecution ever did.

Five wrongs never made one right.



More people, many churches, many religions... all claimed to follow Christ, but carrying it out had immense variations. Who was right? or maybe the appropriate question would rather be: "What was right?" - a that question also relevant for us!

Could we learn anything from history? Isn't it insanity to do the same thing over and over, hoping against hope that the end results will show up better than the time before?

There's one thing better than learning from our mistakes, and that is learning from others' mistakes!

Read Keith Crisler's incredible exploration of the time of Christ up to the Anabaptist movement of the 16th century, and find out how we can learn from the past.

Item# **BO-CH10** (Reg. price \$19.95)



Do our old men dream dreams? (Acts 2:17) What happens when they don't?

What happens when men avoid spiritual subjects because they fear contradicting each other's opinions?

Could it be that we need a generation of men who have never fought against Satan, and don't even know how?

Young men need to fight, or they die. (Jesus God's Kingdom. The fight does not call for weapons that take men's lives. The fight is against Satan himself!)

This book is a plea for older folks to put on the armour of Christ and to encourage younger men to engage in this battle against Satan and the Powers of Darkness! (Eph. 6:10-18)

Item# **BO-GF46** (Reg. price \$15.95)



with Satan waging a deadly battle and our youth on the front lines. Are we equipped for battle?

Are we wearing armour of our own making? Or are we clothed in the armour of God?

How do we older ones equip the younger ones in a powerful and successful way?

Today, possibly like never before, is a time that warrior brothers need to meet together, and with prayerful discernment create a plan of action! It is no time for bickering and squabbling about unimportant issues!

The devil is on a deadly and subtle warpath, and evidence indicates we are only at the kick-off!!

Item# **BO-TT40** (Reg. price \$15.95)

...other buying options; (excludes other discounts)

- (1) Buy all 3 books and get Free Shipping! (save \$10.00)
- (2) Buy 2 sets (6 books) and get a 10% discount plus Free Shipping! (save \$20.37)
- (3) Buy 5 sets (15 books) and get a 15% discount plus Free Shipping! (save \$54.81)

Standard Shipping Prices	
1-2 items	\$8.00
3-4 books	\$10.00
5-12 books	\$15.00

**CALL FOR OUR FREE CATALOG**  
TO SEE OUR FULL SELECTION OF BOOKS..

**The Super-Insulated Triple-Motion Ice Cream Freezer with all Stainless Parts**



**Stainless Steel Housing and Gears with wear bushings.**

**Triple Motion Stainless Dasher**

Polished stainless steel can with durable clear lid



**Hand Crank Freezers**

- 4qt....1004...\$339
- 6qt....1006...\$349
- 8qt....1008...\$399

**Battery Powered Freezers**

- 6qt....DeWalt 20V.....\$589
- 6qt....Makita 18V.....\$589
- 6qt....Milwaukee 18V...\$589

A leak-free molded tub with pressurized insulation that will keep ice for days!

Call for information on air/electric freezers, tubs, and other parts.

Wholesale Inquiries Welcome



375 Old Dam Road  
Christiana, PA 17509  
610-593-5193

Ask for Immergood products at your local store or add \$15 shipping

PA residents add 6% sales tax.

Your Source for **PolyGrip** Clothespins

**PolyGrip**

- Durable UV resistant molded poly
- Anti-twist design
- Stainless steel spring
- Made in USA



100 Clothespins Per Bag

- Pink.... 3051... \$55.00
- Blue.... 3052 .. \$55.00
- Green... 3053 .. \$55.00
- Clay .... 3054 .. \$55.00
- Gray.... 3055 .. \$55.00

12 gray and 12 clay in a pack of 24

- 3045...Pack of 24.....\$15.60
- 3046...Case of 12 packs..\$149.75

8 blue, 8 green and 8 pink in a pack of 24

- 3047 ...Pack of 24.....\$15.60
- 3048...Case of 12 packs..\$149.75



3053 Green



3052 Blue



3051 Pink



3054 Clay



3055 Gray

Wholesale Inquiries WELCOME



375 Old Dam Rd, Christiana, PA 17509  
**610-593-5193**

0-\$45 add \$9.00 shipping  
\$45-\$120 add \$12.00 shipping  
\$120+ add \$15.00 shipping  
PA Residents add 6% Sales Tax



# International Travel Requirements Simplified!

- Purchase airline tickets
- Schedule Covid tests
- Prepare Health Declaration Forms (country specific)
- Provide information about travel questions
- International Travel Insurance

## PalmTec Travel

Philip Miller, PO Box 72, Cave City, AR 72521

Call: 870-705-5900

Fax: 870-259-4809

Email: support@palmtec.biz



**PalmTec** Travel  
Travel made simple!

## Tomato Cages



**"Big Red" Approved!**

"Big Red" Mascot is a trademark of Cedar Ridge Sales

✓ MORE PRODUCE  
✓ LESS HASSLE!



**POTTED CAGES**  
also available

### Square Foldable Tomato Cages

3 Sizes Available

Designed to penetrate earth 10" - up to first crosspiece.

Item #1340

Item #1348

Item #1356



Folds for ease of handling and storage.

- Leg thickness: 5 gauge
- Crosspiece thickness: 8 gauge
- All galvanized steel, spot welded
- Double corner posts for greater strength and stability

Row Cover Friendly Corners – no rips!



## Outdoor Grills

### The Saucer X Grill



- Stainless steel
- Large cooking area – 24" diameter
- Easy locking height adjust
- Swivel base for placement



### The Pony Grill



- Stainless steel
- 24" x 14" cooking surface
- Easy height adjustment



EZ Stake



Self-pounding – no tools required



Call Deb Miller

**717.598.4557 Lancaster, PA**

Call and request a free brochure

Manufactured in the U.S.A.



# ARE YOU LOOKING TO EXPAND INTO THE COMMERCIAL ROOF COATING INDUSTRY FOR MORE PROFITS??

FULL TRAINING PROGRAM  
AVAILABLE FOR BUSINESS  
STARTUP AND PRODUCT  
INSTALL.

Call Today if you would like to have more Profits and be Financially Independent!

- 30%-40% Profitability
- restore vs replace
- low start up cost
- 2-3 man crew

Western Roofers Alliance  
800-557-8966

Best way to  
predict your future  
is to create it!  
Abraham Lincoln

This building owner was very pleased with his Seamless Metal Roof, saving money by restoring vs replacing his roof, and no disruptions to his business when we installed our Fluid Applied Metal Restoration System!





BEST SELLER

**CARHARTT – BOPS6001**  
Lightweight  
Waterproof  
Sizes 7-12,13,14,15.....\$85.95



BEST SELLER

**GEORGIA BOOT – G106**  
Leather, waterproof, slip and oil resistant, comfortable  
Sizes W 8-13 .....\$99.95



GOOD SELLER

**CARHARTT – CMW6174**  
Waterproof  
Breathable  
Sizes W 8-12,13.....\$99.95



BEST SELLER

**WOLVERINE – W04326**  
Durashock with Dri-lex lining. Waterproof.  
Sizes XW 7-12,13.....\$112.95



GOOD SELLER

**ROCKY-7114**  
Lightweight and Waterproof  
Sizes W 8-12,13.....\$123.95

**10% OFF AND  
FREE SHIPPING  
ON ALL BOOTS AND  
SHOES IN THIS AD**  
MENTION CODE PGBE1220



3122 Brown  
3123 Black

**WOLVERINE – 3122**  
Full-grain leather with durashock  
Sizes W 7-13.....\$128.95



**SEQUOIA – 722 6" BLACK**  
Leather Dress or Work Shoe, Comfortable  
Sizes 2E, 4E 7-12,13,14.....\$124.95



**THE MOST DURABLE  
BOOKS ON THE MARKET!!**

These songbooks have lots of favorite songs for children. Size 5.5 x 7.5, spiral bind. It is made out of durable plastic laminated material and is 100% waterproof. This is a very durable book and should last a long time.

Item#1502 32 pgs

\$13.95

Item#1501 70 pgs

\$21.95

CALL FOR  
WHOLESALE  
PRICES

**ROCKY – FQ0005212**  
Waterproof leather  
Gore-tex hiker.  
Sizes W 7-12,  
13, 14.....\$129.95



**Request Free Catalog of 300+ Shoes**

Work Shoes • Dress Shoes • Sneakers • Boots

Phone: (717) 768-7866

Fax: (717) 929-0167

**Progressive  
Shoes**

471 Weavertown Road, Myerstown, PA 17067  
A MAIL ORDER TRADITION

CUSTOMER  
FAVORITE

Bronco  
Brown -  
BRO

**PROPÉT – M3188**  
Waterproof, Leather  
and Lightweight  
Sizes W 7-12,13,14,15.....\$92.95



Black - B

**WOLVERINE – 4906**  
Water proof 6" Leather,  
lightweight  
Sizes M, XW 7-13.....\$92.95



BEST  
SELLER

**MUCK BOOTS  
MUCKMASTER**  
Insulated and  
waterproof  
Sizes Mens'  
7-13, 14

Mid-Hi..... Reg \$115.95  
Hi ..... Reg \$113.95



GOOD  
SELLER

**WOLVERINE – W04821**  
Multi-shox Waterproof  
with great comfort  
Sizes XW 7-12,13.....\$125.95

Add sales tax in the following states, VA 6.2%, IL 8.6%, WI 5.5%, OH 7.25%, IN 7%, KY 6%, MI 6%. All other states are tax exempt.

# G&S GLOVE CO.

A Division of G&S Safety Products

SERVING THE SHOE, HARNESS, VARIETY, HARDWARE AND FARM STORES SINCE 1993

**Hundreds of glove styles in stock and ready to ship**

**FREE  
SHIPPING!**

ON ORDERS OVER \$400

DEERSKIN GLOVES  
NYLON GLOVES  
KIDS GLOVES & MITTENS  
POLAR PILE SUNDAY DEERSKIN GLOVES  
HEAVYWEIGHT BROWN JERSEY / CHORE GLOVES  
GARDEN GLOVES  
DISPOSABLE GLOVES  
SAFETY GLASSES & SAFETY VESTS  
EARPLUGS



**CALL OR WRITE TO REQUEST A CATALOG**

**Phone: 814-476-7908**

**Mail: 10400 Osborne Rd Mckean, PA 16426**



# Charitable GIFT FUND

A TOOL FOR SIMPLIFIED, TAX-DEDUCTIBLE GIVING TO CHURCHES AND CHARITIES.

## The Charitable Gift Fund Program enables donors to:

- Anonymously support the churches and charities of their choice (gifts to individuals NOT permitted)
- Simplify their giving by writing one check to Anabaptist Foundation with disbursements to various charities
- Qualify for an immediate tax-deduction for their contribution and track their giving with quarterly statements
- Give gifts of cash, real estate, or stocks



For a FREE information packet, please contact Anabaptist Foundation



Anabaptist Foundation

55 Whisper Creek Drive  
Lewisburg, PA 17837  
800-653-9817 | info@afweb.org



**Dream Designs**  
CUSTOM FRAMING  
Specializing in custom Graphic Designs...

phone / fax: **717-490-0647**  
sales@dreamdesignscustomframing.com  
812 churchtown Rd - Narvon PA 17555

## CHRISTMAS SALE DAYS!

10% off all in-stock items Dec. 8th - 11th  
call-in or in-store!

\*Clocks.  
\*Song Chips  
\*Christian Books.  
\*Trash cans.

Jeremiah 17

People fear each other because they don't know each other.  
People don't know each other because they don't communicate.  
And people don't communicate because they hate each other.



**New Christmas Chip!!**

Item # 081021

CHRISTMAS SILENCE!

1) The First Noel  
2) Oh Little Town Of Bethlehem  
3) Angels We Have Heard On High  
4) Oh Come All Ye Faithful  
5) Hark The Herald  
6) Jingle Bells

Item# 010918



Item# 021118



Item# 031218



Item# 040218



Item# 050420



Item# 061020



Item# 070421



**To LISTEN TO OUR SONGS CALL 717-490-0647 EXT 1**

# Brighter Dawn Retreat & Clinic



## CLINIC EXPANSION PROJECT

THE CLINIC AND ITS FUNCTIONS ARE USED FOR RESIDENT & OUT PATIENT PROGRAMS  
WE SERVE PLAIN COMMUNITY RESIDENTS FROM MANY STATES.

- WHY** - WE'VE OUTGROWN OUR CURRENT CLINIC BUILDING  
- WE RECOGNIZE NEEDS & OPPORTUNITIES FOR ADDED SERVICES
- WHAT** - PLANNING FOR, A NEW 12,096 SQ FT BUILDING, ADDING MORE  
OUTPATIENT PROGRAMS & SERVICES SUCH AS FAMILY MEDICAL  
DOCTOR, PEDIATRIC CARE, DAYTIME EMERGENCY CARE,  
HEALTH FOOD STORE, ETC.
- WHERE** - AT CURRENT ADDRESS: 108 ROADCAP RD. MILLERSBURG, PA 17061
- WHEN** - GOAL IS TO BREAK GROUND IN SUMMER/FALL OF 2022

### FUNDRAISING COMMITTEE

- Sylvan Stoltzfus 570-682-8605
- Abner King 717-365-8012
- Amos Stoltzfus, Jr. 717-461-6379

### OPPORTUNITIES TO DONATE

- Monetary Funds
- Monetary Pledges
- Building Material Pledges  
(Contact Fundraising Committee to Make a Pledge)

Yes, I would like to donate for the expansion project at Brighter Dawn Clinic

\$100  \$250  \$500  \$1,000  \$5,000  \$10,000 \$ \_\_\_\_\_ other

Check box if you want a receipt mailed to you

Name \_\_\_\_\_

Address \_\_\_\_\_

City/State/Zip \_\_\_\_\_

Phone # (Optional) (\_\_\_\_\_) \_\_\_\_\_ - \_\_\_\_\_

Mail Donations to

### Brighter Dawn Clinic

108 Roadcap Rd, Millersburg, PA 17061

Anonymous Donations can be sent through  
Anabaptist Foundation 55 Whisper Creek Drive  
Lewisburg PA 17837  
write "Bright Dawn Clinic Expansion"  
on your Memo Line

*Thank you for your prayers and support!*

### STATEMENT OF PURPOSE

"To make provisions for expanding and enriching our healthcare services to the plain communities"







# A Three-Year Project

## Pressures a Steam Engine Enthusiast

LEROY MARTIN





A few times each year, billows of white steam float into the sky at Maine's far-northern Amish community. The Fort Fairfield community is a picturesque one; even more so when you manage to see a steam traction engine puffing within proximity of a horse and buggy that is navigating its way through a countryside dotted by fields of potatoes, small family farms, and narrow back-country roads.

To catch up with John Yoder, a steam tractor enthusiast, I journeyed to Maine to observe the project that he had been working on sporadically throughout the course of three years. "It's just a hobby of mine to own something like this," he quickly assured me upon my arrival. "I hardly use it to perform work-related duties. However, there has been a time or two that we used the steam tractor in the garden and in the field."

"I was ten years old when I first began entertaining the idea for this project," Yoder continued. "I had so many dreams back then of owning a steam tractor. As I grew older, the desire didn't dissipate, instead it grew stronger and settled deeply within me. To learn more about steam tractors, I subscribed to a magazine called *Engineers and Engines*. I studied each issue intently and learned a lot."

Yoder explained that he looked around for several years, searching for an opportunity to purchase a steam traction engine. "To my disappointment, I quickly learned that they were out of my budget. I just couldn't afford to purchase one," he explained. "The cheapest ones that I saw were selling for fifty-thousand dollars, and they were in pretty rough shape."

But he still felt that he needed a steam traction engine in his life, and he was not about to give up on his dreams. Therefore, the necessity breathed way to invention.

"I decided that I would build one on my own," he said. "It would be less expensive, I assumed. A neighbor was kind enough to help me with ideas for my project. He was a retired farmer who had an oil-pull collection and took an interest in my dream of making a steam traction engine that I could tinker with. I was able to purchase a few parts for my project from him."

Yoder purchased the steam engine that he used for his project from a fellow in Kentucky. The boiler itself was ordered and produced by J&S Machine, from Middlefield, Ohio. (I interviewed this business—the article appeared in



A closeup of the mechanical wonder on a Maine farm.  
Photo credit: Paul Cyr

the November 2019 edition of the PCBE).

"The men at J&S did good work," Yoder remarked. "There was a waiting list that I was placed on, which consisted of approximately twelve months until I received my boiler. I provided them with specifics and told them what I wanted to use the boiler for. I had never seen a steam engine operate prior to this, so there was so much that I didn't know."

The steel-wheeled rims for the tractor were special ordered from *Farm Bilt*. "The rims were manure-spreader rims—I just provided the folks at *Farm Bilt* with the diameters that I was looking for," Yoder explained. (*Farm Bilt* is located in Pennsylvania).

"I also took it upon myself to study pictures of steam engines that I came across in magazines," he added. "While I was a scholar, I had a tough time of it at school. I didn't learn well. But when working with engines, it seemed it was something I could learn more easily."

Three years passed by and many countless hours were spent working on his project before Yoder began to see tangible fruits of his labor. Even before he had begun his project, he wasn't sure that it would be a successful venture. "Some people told me it would be difficult."

Benuel Esh, an Amish man from a neighboring community, proved to be a great help to Yoder throughout the project. "Benuel had a steam engine of his own and was able to provide me with lots of helpful advice. He told me how things work. Throughout the project, I performed a lot of modifications to the steam tractor."

*Steam Engine Enthusiast - Continued on Page 18*

Yoder's project pushes steam during a display.  
Photo credit: Paul Cyr



An opened door reveals a hot fire.  
Photo credit: Paul Cyr

### Steam Engine Enthusiast - Continued from Page 17

When he initially fired the steam tractor, a rudimentary water tank had been attached to the top. “It was an old soap barrel,” he explained. “Whenever the water passed through and entered the tank, there was a great deal of foam which was produced. The large amounts of foam wanted to suffocate our rig; we just couldn’t understand it. But when we removed the soap barrel and fastened another one in its place, it worked quite well. No problems with foam from that point on.”

An upright boiler with a diameter of three feet is secured to the tractor. The boiler’s height is seven feet. Three hundred gallons of water will fill the boiler to capacity. “The water that is placed in the boiler is pre-heated,” Yoder explained. “Earlier, when we relied on cold water, we usually needed to wait a long time until the steam built to the desired pressure.” (Yoder installed a pre-heating line which runs through the exhaust).

The boiler is certified and meets all required safety regulations. In fact, it *exceeds* safety requirements. “I told the manufacturer that I want double safety valves throughout. I planned to operate the tractor in the presence of my neighbors and family, and I didn’t want a disaster to occur. The integrity of the boiler was my main concern—I wanted it to be as safe as possible.”

After the boiler was manufactured, it passed through an X-ray machine, to check for cracks and any weak spots. It was deemed safe; no problems areas were detected.

“Brass plugs are outfitted to the bottom of the boiler. The

reason why a steam engine tends to blow up is when the water levels within the boiler are permitted to dissipate to unsafe levels. Now, in a situation like that, if there is still a nice fire, the boiler will eventually turn red hot, due to the absence of water in the boiler. Therefore, if cold water is introduced to a red-hot boiler, the steam build-up will be fearsome. The pop-off valves can’t take it, therefore, if a boiler does not have brass plugs, the boiler can blow up,” Yoder explained.

Yoder’s boiler is equipped with brass plugs, which will melt whenever the boiler becomes too hot—due to the absence of adequate water levels. Therefore, Yoder’s boiler is deemed quite safe, since the steam could escape through the holes which the melted brass plugs would produce. “The manufacturer told me, with the technology that is utilized currently to produce these boilers, it’s nearly impossible to blow one up accidentally.”

Assembling the steam traction engine was a major task, and Yoder performed all the work by himself. While he was doing the assembly work, he began having doubts of his own. “There were a few things that could go wrong, I was aware of that. In fact, I was very surprised when everything worked well upon completion of the assembly process,” he explained.

Yoder assumed if a hang-up was to occur, it would likely be with the gear-ratios. “I was nervous that I might not have those ratios figured correctly,” he said. “Also, I wasn’t sure if it wouldn’t take too much power to move the tractor forward. There was potential that the tractor would be too



heavy to move with the amount of power that I had.”

Throughout the duration of the project, as Yoder labored in his shop primarily during the winter months, several neighbors stopped by to take a look. The project raised interest among the neighbors as well as other folks who heard of it. “Right at the beginning of the project, more than a dozen folks came to observe.”

The tractor is powered by wood or coal; these two fuels work best, according to Yoder. “Wood or coal fire is best to build up the desired pressure in the boiler. It works best to mix wood and coal, but it can also work to either burn wood or coal only.”

Sixty pounds of pressure is needed to coax the heavy machine into the moving stages. “On a flat surface, sixty pounds is adequate. But let’s say I would be trying to go up a steep hill with the tractor, then I would need much greater pressure, perhaps as much as one-hundred and twenty pounds.”

Yoder recalls attempting to tackle a significant hill with inadequate power at his disposal. It posed a problem for him and his helper. “We were required to stop twice before we reached the top. Each time that we stopped, we allowed the steam pressure to build.”

Pressure gauges need to be observed and monitored regularly. There is a very real possibility of steam reaching such great a pressure, that the pop-up safety valves will release. “The maximum build-up pressure for the steam within the boiler is one-hundred-and-seventy-five pounds. If there is any greater number than that, steam will be released

via the safety valves.”

The steam engine that powers Yoder’s tractor is considered the equivalent to that of a one-hundred-twenty horsepower diesel. “At least that is what people told me,” Yoder concluded.

Primarily a toy, the steam traction engine could be utilized for small projects around the farm. “The bucket attachment works well to distribute gravel,” Yoder said. “The bucket is gear-driven, allowing for up and down movements.”

The ‘toy’ proved to not be so much of one when it was matched to a Chevy pickup. Yoder recalled the encounter with a chuckle. “When I was driving along one of the bigger roads here in our area, people were slowing down and parking their cars along the roadway, looking on in disbelief.”

“They all wondered what it was that they were looking at. Pretty soon a Canadian came along—the border is only a few miles from our community—and the man was driving a Chevy pickup truck. After observing our rig for a while, the man informed me that he would like to hook his truck to the steam tractor and pull it along. I permitted him to do so. It turned out that I was the one pulling him, by the time the steam had settled. The tractor had been pulling the pickup no problem. It didn’t take long until the driver instructed me to stop.”

*John Yoder resides in Fort Fairfield, Maine. He is a steam-power enthusiast and works at a truss shop. The mailing address is: 504 Station Road Easton ME 04740*

Researched, written, and edited by *Leroy Martin* for the exclusive use of the *Plain Communities Business Exchange, LLC*.



Yoder enjoys tinkering around with steam traction engines.  
Photo credit: Paul Cyr





**Samples In Issues...**

- Daniel Webster's...Days
- Russian Famine
- Christmas Buck
- Children's Lessons
- Jack's Step
- Hidden Pictures
- Rabbit Hunting...
- Raising The Pearl
- Pearls and Oysters
- In The Land...Mirage
- Kathryn's K...
- The Canal E...
- The King's I...
- With Friends...
- When Silence...
- Lost In...Cornfield

**Stories of the Month**

- About Elephants
- Edison and Electricity
- The Fortunes Of Toby,,,

**Great stories and games for all ages.**

**\$25.00 DISCOUNT**  
**ON 6 YEAR RENEWAL (\$185.00)**



*12 Issues a year (1 every month)*



**GREAT  
MAGAZINE  
WITH  
SECTIONS  
FOR ALL  
AGES**

# HOW THE RAIL-SPLITTER RAISED HIMSELF

From The True Story of Abraham Lincoln - by Elbridge S. Brooks

BOYS and girls always like change. To them, it means new places to explore, new sights to see, new things to do. As they grow older, it means, so they think, a better chance to get on in the world.

When, therefore, restless Thomas Lincoln, the father of Abraham, decided to change his home once more and try his hand in the neighboring state of Illinois, young Abraham was unflinching ready to make

home. Abraham Lincoln was twenty-one. He was 'of age he was a man!' By the law of the land, he was freed from his father's control; he could shift for himself, and he determined to do so.

This did not mean that he disliked his father. It simply means that he had no intention of following his father's example. Thomas Lincoln had demanded all the work and all the wages his son could do or earn, and Abraham felt that he could not have a fair chance to accomplish anything or get ahead in the world if he continued living with this shiftless, never-satisfied, do-nothing man.

So, he struck out for himself. But lest you should imagine that he 'went back on' his family, as you boys say, or forgot his duty to them, especially to

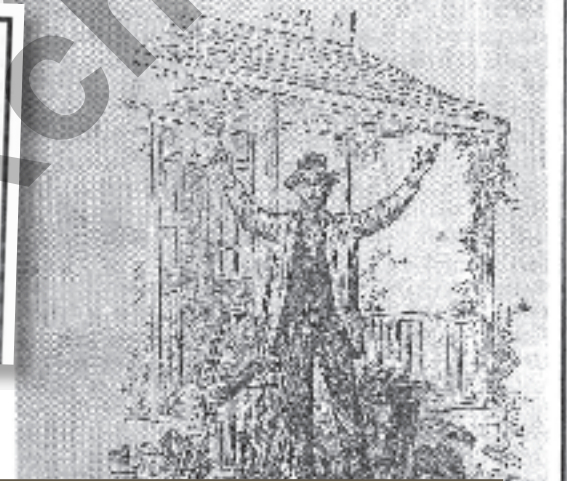
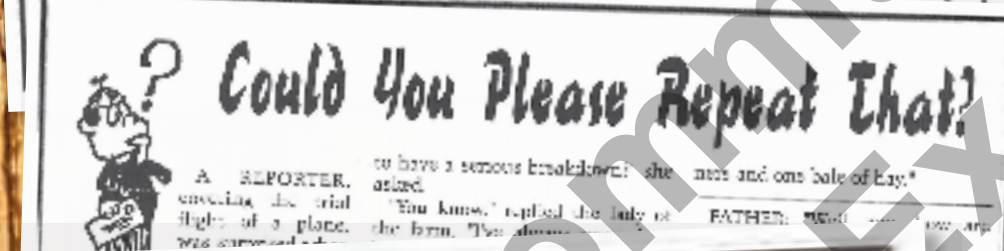

## THE OLD COUNTRY NEWS SUBSCRIPTION

### PRICES

Name: \_\_\_\_\_

Address: \_\_\_\_\_

City: \_\_\_\_\_ State: \_\_\_\_\_ Zip: \_\_\_\_\_

Phone: \_\_\_\_\_

- 1 year at \$35.00
- 2 years at \$65.00
- 6 years at ~~\$210.00~~  
**\$185.00**

- Canadian Rates**  
US Dollars
- 1 year at \$70.00

Office use

Mail Subscriptions to:  
Old Country News, 420 Weaver Road, Millersburg, PA 17061



# Tell Me the Stories of Jesus

No extra-Biblical details. No cartoon-style artwork. Only simple Bible stories brought to life with striking, original oil paintings.

**\$22.50** 155 pages, hardcover

We are reading *Tell Me the Stories of Jesus* and loving it! It is a masterpiece, both the text and the artwork. —family from Ohio

Order today to give your children or grandchildren a gift of lasting value.

\$5.00 shipping. Free shipping over \$50. VA, PA, and OH residents add sales tax.

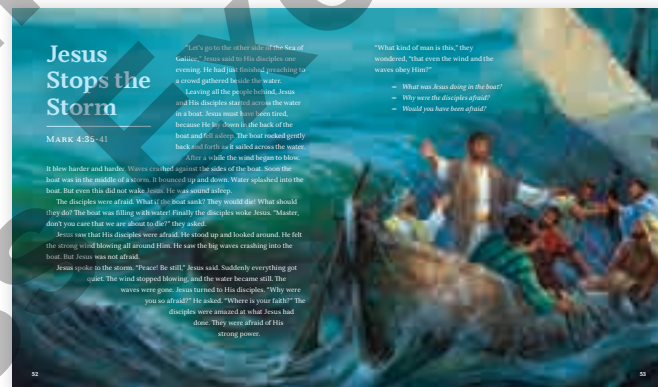
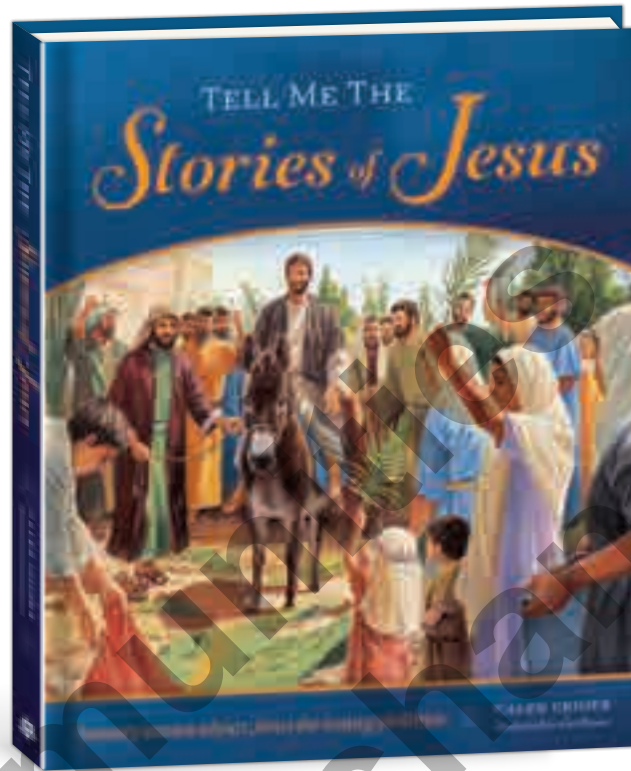

Sample pages

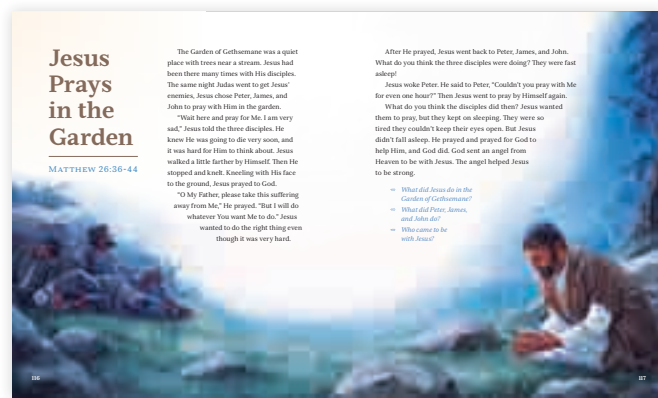

**CHRISTIAN LIGHT**  
PUBLICATIONS

1.800.776.0478 | [www.christianlight.org](http://www.christianlight.org)  
P.O. Box 1212, Harrisonburg, VA 22803-1212





**FAMILY OWNED & OPERATED**  
*Products Sourced & Made in USA*  
 Wholesale mattress manufacturers with select territories available



**Complete Line of Bedding**

- Memory Foam
- Latex
- Specialty Foams
- Pocketed Coils
- 2-sided
- Pillow-Top
- Heavy Duty Boxsprings
- Adjustable Bases w/Massage

1770 N 500 W | Shipshewana, IN 46565 | phone 260.768.7875 | fax 260.768.7099

[www.heartlandmattress.net](http://www.heartlandmattress.net)

**NEW PROCUT BAND RESAWS**

**HILLTOP WELDING & FABRICATION**  
 660-748-4061

**PROCUT HEAVY DUTY UP-CUT CHOP SAWS**



- Single or Multi-Cut
- Heavy-Duty Construction
- High-grade Components
- 6" x 12" Cutting Capacity
- 28" Bandwheels
- Fast Precision Adjustment with Mechanical Counter

Your Power Choice: Line Shaft Ready, Electric or Hydraulic



(Optional) Air Controls & (Optional) Live Rollers

- 3" HD Built Rollers with 1" Pillow Block Bearings (8' Infeed / 8' Outfeed)
- Convenient Manual Hand-Powered Blade Operation
- 22" Blade w/ Dust Collection System
- 7"x 9" Cutting Capacity
- (4) Flip Stops • (3) V-Belt Drive

Your Power Choice: Line Shaft Ready, Electric or Hydraulic



*Handi Square*

**For Contractors + Homeowners**

**THE SQUARING TOOL**  
 For New Construction

- Opens to square position
- Hand-adjustable string adjusts in all directions without tools
- Folds for compact storage
- Aluminum construction
- Easy-to-read measuring tape



**660-748-4061**  
 27999 Highway A  
 Princeton, MO 64673

Also Available from:

- Airworks LTD. Apple Creek, OH • 330-698-0388
- Alpha Building Center Shipshewana, IN • 260-768-4410
- Central Michigan Roofing Bellevue, MI • 269-758-3330
- Eastern States Metal Roofing Panama, NY • 716-355-4374
- Graber Building Supply Sullivan, IL • 217-543-3259
- Keystone Air Power Myerstown, PA • 717-866-9224
- Ridge and Valley Metal Craft Dover, DE • 302-678-2272
- Rising Sun Supply Rising Sun, MD • 410-658-9587
- Stoll Brothers Lumber Inc. Odon, IN • 812-636-4053

# Superior Poultry Products

Coops Designed by a Chicken Farmer



## Layer Options

10x12.....50 - 60 Layers or 80 Broilers  
6x10.....24 - 30 Layers or 30 Broilers  
5x6.....10 - 12 Layers or 15 Broilers



## Turkey & Broiler Options

12x24.....200 Broilers or 75 Turkeys  
12x12.....100 Broilers or 36 Turkeys

## Why Choose a Coop from Superior Poultry Products?

- Coops designed from a chicken's perspective!
- Our Alpha-Lite Wheel System™ allows them to be easily moved by women & kids.
- CNC cut 18 oz. Shelter-Rite Vinyl Cover will keep your birds cool in summer and with our new 4-seasons option you can now use our coops year round!
- Built to last with an appealing aluminum frame that will dress up your backyard or pasture.
- Our proprietary brand, Yuneek Nest & Roost System, will keep your eggs clean and less prone to damage—increasing production!
- Our new Superior brand outside feeding & watering system is designed to increase your feed efficiency and speed up chore time.





# Superior Poultry Products

News – Tips – Product Reviews – Features

## Our Story

Regenerative, pasture-based farming and heritage-breed chickens have always been my passion.

Our story starts in 2012 when we bought our first 50 Layers and built our first coop. It was built with wood and basically styled after Joel Salatin's coop models which were developed in the 1960's.

After several years of back-breaking work, we decided that there had to be a better coop design that works better for our farm.

After several iterations, Alumi-Coops were developed with these three key features in mind:

1. A smooth, adjustable, wheel system (our proprietary AlphaLite Wheel System™).
2. Built to last with an aluminum frame.
3. Designed from a chicken's perspective to completely eliminate stress, therefore gaining more production.

Feedback from broiler growers from New York to Texas has been very positive. There are a lot of reports of faster weight gains and better feed efficiency. Some have achieved grow outs never before obtained in pastured poultry to my knowledge! All of them are raving fans of our AlphaLite Wheel System™! Ready to upgrade your broiler or layer set up? Stop in or call your local dealer today.

Respectfully yours,  
David Miller and SPP Team

*For your convenience these three dealers are set up to ship directly to your farm!*

### **Pennsylvania**

Georgetown Sales LLC  
(610) 593-5193

### **Ohio**

Ackerman's Equipment & Rental  
ackermansequipment.com  
(330) 674-0495

### **Indiana**

Michiana Sales  
(574) 642-4768

### **Indiana**

Michiana Farm Supply.....260-463-8113  
Millersburg Feeds.....574-642-9925  
Midwest Farm & Pet.....574-646-2509  
Backyard Creations.....765-562-3308  
Black Creek Farm.....260-750-2781  
Barns Unlimited.....765-489-6282  
Graber Farm & Home.....812-636-7880

### **Kentucky**

KY Organic Farm/Feed..270-265-5004  
Stoltzfus Playstructures..270-881-4207  
Cub Run Milling.....270-524-4702  
S. Kentucky Wood Furn..270-459-1840

### **Iowa**

Yoder's Ind. Creek Furn.....319-538-7332

### **Missouri**

LNS Feeds.....660-337-6206  
Trim Line Barns.....417-246-5666

### **Michigan**

The Roost Farm.....269-808-8480  
Sunrise Farms.....231-829-3265  
Stutzman's Poultry Pro.....517-568-4764

### **Wisconsin**

Wagler Farm Supply.....715-569-0188  
William Yoder.....608-625-2412  
ENK Poultry Solutions.....608-360-4078

### **New York**

Featherbrook Farms.....717-344-2284  
Hillside Supply.....585-567-4662

### **Illinois**

Slabaugh's Outlet.....217-543-3493

### **North Carolina**

Winding Star Nursery.....828-369-9778

### **Tennessee**

Crossing Creeks Farms...615-767-6745

### **Arkansas**

Newswanger Produce & Garden Center  
870-370-3370

### **South Carolina**

Clement Farm Division..512-844-7784

### **Texas**

Texas Shed Masters.....254-205-5209

*Direct dealer inquiries to one of our distributors:*

### **PA and Mid-Atlantic States**

Georgetown Sales LLC  
(610) 593-5193

### **Canada**

Gateway Sales LLC  
(800) 705-4221

### **All Other Areas**

Superior Poultry Products LLC  
(260) 463-2919

# the DISConnected™

## WORKPLACE

by Leon Yoder

*The DISConnected Workplace is a series about the struggles of a small business with the 4 primary characters representing the 4 DISC personalities.*

## Creating The Right Culture

“If our success depends on us changing Phineas, it’s sure not looking good for us,” Dean said. “He seems to have this attitude that we could never do without him.”

“I know. He does have a bit of a chip on his shoulder,” Sam agreed. “But Caleb is right. We need to focus on improving our systems and providing clear expectations and then if Phineas doesn’t want to cooperate, we can let him go. But even then we need to try to preserve the relationship. If he’s not a good fit for our team, that’s okay, but it doesn’t give us the right to be disrespectful.”

Caleb smiled as he looked up from the notes he was writing. “I know this might sound strange, but I feel good about the problems we have.”

Problems can be stepping stones to better solutions.

Dean looked at him sideways. “Are you okay?”

Caleb chuckled as he continued. “If we didn’t have these problems, we wouldn’t need to improve anything. Problems can be stepping stones to better solutions.”

“Does a better solution include better employees?” Dean asked.

“I think it does,” Caleb replied. “You have that interview with a new hire coming up, and I think this is a great time to improve our hiring process.”

“Don’t we first have to have a process before we can improve it?” Dean needed.

“Well, we do have a process,” Caleb replied quickly. “It’s just not a consistent process nor written down. It’s called *winging it*.”

“That would be correct,” Dean conceded. “What did you have in mind?”

“I think we need to focus on hiring the right attitude. You’re right in what you mentioned about Phineas. It will be difficult to change his attitude. So here’s the first principle I wrote down. Hire the right attitude and train for the work.”

“That’s good,” Dean agreed. “We know what the wrong attitude looks like. What does the right one look like?”

“I think they need to be respectful,” Sam said. “We want to



## GLANCE AT LAST MONTH

*Coach and Caleb discussed what systems look like in a business. Phineas forgot to bring back a nailer he had borrowed and had also stacked up some ‘scrap’ that he wanted to take home. Dean was not happy and wanted to fire him but Caleb reminded him that it was partially their fault for not having good enough systems in place.*



be respectful to our employees. But we also need them to be respectful to one another.”

“That’s right,” Caleb said, making a note of it. “They also need to have a desire to learn. If we are going to have a mindset of continuous improvement, our employees will need to buy into that concept as well.”

“I agree,” Dean said. “I’m stomping on my own toes right now, but we need to be able to admit when we are wrong. You know, on that very rare occasion.”

“Yes, certainly quite rare,” Caleb said jokingly. “I seldom get the chance to work on that one. But seriously though, we can’t fix a problem or correct a mistake until we recognize that there is one.”

“You are right,” Sam said. “It’s important we own our mistakes. You both have great ideas. I’ll let you continue without me. I’m heading to town for our monthly business group luncheon.”

“We’ll try to leave a few problems for you,” Dean said, waving him off.

After Sam left, Dean looked at Caleb. “We are pretty blessed aren’t we. I sometimes take for granted how much Dad invested into this business to give us the opportunities we have.”

Caleb nodded as he added to his notes. “Gratefulness. I think that is another principle we need to practice. It’s really hard to be grateful and complain at the same time.”

“I agree,” Dean said. “It’s one thing to practice these principles ourselves, but how do we convey them to our employees?”

“I think I know what Coach would say,” Caleb answered. “He would probably tell me to not only practice it but talk about it to the employees. He recommends that we do regular shop meetings to discuss improvement projects and other topics like this.”

### DISC in Communicating

#### D - Dean

A **D** will often speak in shorter sentences. Short and to the point. Not wasting words. Focused on doing rather than feeling. This can sometimes come across as uncaring or being too blunt. But other D’s and I’s will appreciate the efficiency.

#### I - Ian

An **I** enjoys talking to people. They are usually entertaining and bring life to any conversation. Their joy of talking sometimes hinders their efforts in listening. They tend to make broad sweeping statements that may not feel accurate enough for a C.

#### S - Sam (Dad)

An **S** is usually a pretty good listener and often prefers listening over speaking.

#### C - Caleb

A **C** likes to ask questions. They think things through and are cautious because they want to get it right. Broad statements and exaggerations may feel like a lie to a C.

“Sounds like a good idea as long as you lead the meetings,” Dean said.

“I was afraid you’d say that. But leading a meeting doesn’t

*DISConnected Workplace - Continued on Page 28*



*DISConnected Workplace - Continued from Page 27*

scare me as much as it would have even a year ago. I used to think a meeting was this formal thing where everyone sits around listening to someone else speak. The person leading the meeting has it all together and no one else says anything.”

“Sounds scary to me,” Dean admitted.

“Glad I’m not the only one that thinks that,” Caleb said. “But I don’t believe that is the picture of an effective meeting. Might be what happens in a church meeting or a seminar, but I think a shop meeting should simply be a meaningful group conversation. Coach gave me a couple of pointers. He said the meeting should be relaxed enough for people to speak but structured enough to keep them from chatting about things that don’t pertain to the topic. A key thing is to be able to ask great questions that inspire people to share feedback.”

“Sounds simple enough. I think you should try it,” Dean said.

“Sure, nice try,” Caleb chuckled. “I do think that we need to get comfortable having shop meetings. We will need to be able to communicate these ideas to our employees.”

“I agree,” Dean said. “I like seeing it as a group conversation where we can discuss our goals. Talking about what we are trying to achieve without us needing to have it all figured out before we talk to them about it.”

“Yes. They can help us solve the problems,” Caleb said. “I tell you what. I will take the lead on the first meeting if you promise to help out.”

“Deal,” Dean said. “I think a topic for the first meeting could be to simply talk about our idea on continuous improvement. Ask them for ideas and then make a list to work on.”

“I like that,” Caleb agreed. “I would also like to pick one of these attitude principles to discuss. What would be a good one to start with?”

“You had mentioned the desire to learn. I think that would go well with continuous improvement because we can’t do

improvements without wanting to learn something.”

“Sounds good to me,” Caleb said. “Do you want to split this? You talk about continuous improvement and I take the desire to learn?”

“Sure,” Dean agreed. “I would find that easier to talk about than the desire to learn.”

“Okay,” Caleb said. “Let’s have an employee meeting tomorrow right after their first break.”

“Perfect. That way I can prepare for that interview this afternoon and get that out of the way first,” Dean said. “Do you have time to go over some of the questions I should be asking? I’d like to review that process and maybe I won’t have to *wing it*.”

“Sure,” Caleb said, looking at the clock. “I have to leave in an hour to meet the cabinet installer at my house. I’m happy this remodel is almost done.”

The next morning Caleb was already at the office when Dean entered, beaming and full of energy. “I believe we found our new employee.”

“That’s great,” Caleb answered. “Tell me about him. How did he do on your interrogation, or interview, I mean.”

Dean just laughed and continued, “He handled it well. He seems to have the right attitude. His eyes lit up when I told him about our goal to be a company that is always learning and making improvements and that we want our employees to be involved in identifying and making those improvements.”

“What’s his work experience?”

“He has been doing construction for the last 6 months, but does not like his current work environment,” Dean said. “So his construction skills are a little limited, but I think he will do well. I’d prefer that over someone who thinks they already know everything and isn’t teachable.”

“So when could he start?” Caleb asked, not looking up from a note he was writing.



“He’s ready to start this coming Monday if we are ready for him,” Dean answered. “He had already given the company a notice that he’ll be done by the end of this week.”

“That sounds great,” Caleb said, laying down his pen. “Let’s run it past Dad yet, but I would be good with letting him know that he can start on Monday. What about the employee meeting this morning? Are you ready for that?”

“I believe I’m ready,” Dean replied. “You?”

“I am now,” Caleb grinned. “Thanks for the help.”

“What did I do?” Dean asked, looking perplexed.

“You mentioned some key words when you were describing the new employee,” Caleb said. “You said that he was teachable and that we want to be a company that’s always learning. These are good words to describe what we want to convey to the employees this morning.”

“Glad I could help,” Dean said.

Sam joined the boys in the office a few hours later, just before the shop meeting and Dean shared his information about the new job applicant.

“He sounds like the kind of person we need. I’m okay with having him start right away. Did you do anything different for the interview this time?” Sam asked.

“Yes,” Dean replied. “The biggest difference was in what I was listening for. I started by asking more questions about what he enjoys doing outside of work. Asking less questions about his abilities and more about what he did and didn’t like about his current job. I think my favorite question was when I asked him to describe a great workplace. Having better questions made the whole interview process less stressful and I think he enjoyed it as well. I gave him the DISC assessment and explained it briefly. He seemed quite intrigued and asked a number of questions about it. That told me that he is open to ideas and is teachable.”

“That’s great!” Sam replied. “It means a lot to me to see the energy you two are putting into this business. I’m looking forward to seeing how this shop meeting goes. Oh, and

by the way, I met a new person at our business luncheon yesterday. Carl and his wife own a construction company and they have Coach working with them as well. They are doing a character development program with their employees. He brought a few samples that he was showing to the group. You get materials for a different character principle each month with copies for all the employees. Best of all, it is based on biblical principles. I thought it might be something worth looking into.”

“That sounds great,” Caleb said. “I don’t know how much time I spent trying to get some ideas put together for this meeting and I still feel like I don’t have much to work with.”

“Well, let’s go see what you have,” Sam said with a grin.

Break time just ended as Sam, Dean, and Caleb joined the rest of the employees. Dean and Sam sit down with the others, and Caleb grabs a bar stool and sits at the end where he can see everyone.

“You might be wondering why we are having a meeting,” Caleb began. “Well, don’t worry, we are wondering the same thing.”

Everyone gave out a little chuckle and a few of them grinned, the awkward tension in the room seemed to lift. It was obvious that the idea of having a formal shop meeting felt a little awkward for everyone.

“Our main goal is to become a better company, which means providing a better product and service for our customers.” Caleb continued, “This is not to say that what we’re building now is not good, because it is. We have a really good product. But a healthy company is always growing and we believe that the best kind of growth is growing better and not just bigger. That brings us to

the reason for this meeting. We cannot become better by ourselves. We will need to work well as a team. We will need to communicate to you what the customer needs and we will need you to help us figure out how to provide that in the best way possible. This means trying things that don’t always work but always trying to improve how we work.



*DISConnected Workplace - Continued on Page 30*

*DISConnected Workplace - Continued from Page 29*

Always approach a problem as an opportunity to improve something.”

Caleb began to feel a little more comfortable with each word he said. “This brings me to our principles. The attitude of how we do business. Becoming a better company also means becoming a better workplace. Our attitudes are important because no one wants to work in a stressful environment. I know that sometimes I don’t have the best attitude. It’s challenging when a customer calls and complains or a supplier can’t get our materials here on time. Then one of you comes to me with a problem and I don’t respond the way I should. I want to improve my attitude. Even when it seems like it is someone else’s problem, there’s usually something I can do to be helpful. One of our core principles is to be a learning organization.

The biggest barrier to learning is thinking we know.

To continue to be successful, we will need to keep learning and improving. And in order to keep learning we will need to be teachable. The biggest barrier to learning something is to think we already know. Dean is taking the lead on coordinating these improvements and keeping track of the ideas that you have. Our goal is to improve our processes and make things easier rather than just trying to work harder. I’ll let Dean share his ideas on improvements. I know this hasn’t been much discussion and mostly me talking. But does anyone have any questions so far?”

After a few moments and no one asking any questions, Caleb gave Dean a nod.

Dean appeared pretty calm as he began. “Like Caleb already said, we want everyone involved in making improvements. No one knows your job better than you do, so you have an advantage when it comes to making improvements. You also have a disadvantage. You are so close to your work that it is hard to look at it from a completely new perspective.

To step back from your work and completely reevaluate what you are doing is difficult. It can feel like others think I wasn’t doing my job well enough. But that’s not true. We are all doing the best we can with what we have right now. But we cannot improve if we believe there is no better way. We need to have the mindset that there is always a better way of doing what we are doing. This will be key to our continuous improvement. So does anyone have ideas on how to find things to improve?”

Everyone was quiet for a while until one of them jokingly

said, “Probably listen for complaints.” This brought a few snickers from the others.

“You’re exactly right,” Dean said. “The key to making improvements is to be aware of problems. Problems and complaints are a great starting point for any improvement. The challenge for the week is to look for complaints. I will have a dry erase board here on the wall with a list of problems or complaints and then we will pick a few at our next meeting and brainstorm ideas on how to fix those problems.”

The serious consideration of what was intended to be a joke suddenly got everyone’s attention.

“I’d like each one to find at least one thing that you think we could improve.” Dean said. “Try to have those by our meeting on Friday. Thank you. I really appreciate all your efforts and look forward to hearing your complaints.”

**Continued next month...**

*Leon Yoder is a business coach, writer, and certified DISC consultant located in northern Indiana. His background is in manufacturing and is trained in Lean Six Sigma. Leon started a sign company that he sold after 20 years. He assisted many businesses and startups with graphic design and marketing. Leon has been involved in numerous organizations and startups including an event center in Shipshewana, IN. He currently owns Black Anvil Media, Inc, a web development, and marketing company as well as his consulting company, Sycamore Systems, Inc. Leon enjoys theology, Anabaptist history and is passionate about growing people in faith and business.*

*Black Anvil Media, Inc - 574-747-8050*

*Sycamore Systems, Inc - 574-400-5844*

**Lodestar Guidance**

*is designed to be easily shared with your employees each month. Full color printed folders with a self assessment for each employee plus an easy to use leader guide with questions to generate discussion.*



A monthly, faith-based leadership development program based on 48 character principles that empower employees to live and lead effectively.



**Call or Email for more info:**  
**574-400-5844 • [disc@leonyoder.com](mailto:disc@leonyoder.com)**



# Christmas Special

OFFER EXPIRES  
12/15/2021

## DISCconnected™

### LEADING AND LEARNING

8"x 5" paperback, 144 pages

**Carl knew construction well. How hard could it be to run your own business?**

When Carl starts his own construction company, he is faced with a new set of challenges. Building relationships is even more complicated than building houses. He discovers that growing a business requires growing people.

This story of Carl's business is built around the DISC behavior model. The four main characters represent each of the primary DISC temperaments. Each chapter gives insight to the personalities of each character.

#### Learn more about:

Making the transition,

- From Employee to Entrepreneur pg 15

Charging for design work in,

- Problems with Paying for Paper pg 25

What to look for in your next employee.

- Hiring Based on Character pg 85

Incentive based pay that works.

- The Pitfalls of Profit Sharing Pg 97

Some practical ideas for managing the clutter.

- Sticky Solutions and a Messy Desk pg 119

#### About the Author

Leon Yoder is a business coach, writer, and certified DISC consultant located in northern Indiana. His early background is in manufacturing and he is trained in Lean Six Sigma. Leon currently owns Black Anvil Media, Inc, a web development and marketing company as well as his consulting company, Sycamore Systems, Inc.

The information printed in this book is compiled from the DISCconnected Workplace series that was printed in PCBE from May 2020 to April 2021



#### ORDER FORM

**FREE SHIPPING ON ALL ORDERS**

SHIPPING PRICES DO NOT REFLECT RATES FOR CANADIAN ORDERS. CALL FOR INTERNATIONAL SHIPPING RATES.

<b>LEADING AND LEARNING</b>	<b>\$11.89 each</b> <del>\$13.99 each</del>	
	PA Residents add 6% Sales Tax	
	S&H (USA ONLY)	<b>FREE</b>
<b>TOTAL</b>		

Name: \_\_\_\_\_

Address: \_\_\_\_\_

City: \_\_\_\_\_ State: \_\_\_\_\_ Zip: \_\_\_\_\_

#### CREDIT CARD INFORMATION (We accept all major credit cards.)

Account No. \_\_\_\_\_

Expiration Date: \_\_\_\_/\_\_\_\_ 3 Digit Security No. \_\_\_\_\_

Card Holder: \_\_\_\_\_

Signature: \_\_\_\_\_ Zip \_\_\_\_\_

Order from:

PCBE Attention Book Order – PO Box 520, Millersburg, PA 17061

**Orders must be prepaid (Make checks payable to PCBE)**

**WHOLESALE INQUIRIES – Contact: 717-362-1118 ext. 300**



# PerformAA™ Takes the Guesswork Out of Wood Finishing



At 460 grams, PerformAA is the lightest air assist (AA) spray gun around. And no other comes with material-specific air caps.

Each PerformAA air cap produces the best atomization with the least amount of guesswork when spraying a certain material. Of the seven available, cabinet makers, furniture manufacturers and wood shops especially benefit from:



**Wood Lacquer (WL)** to apply top coats and lacquer



**General Finishing (GF)** to atomize tails at low pressures with enamels and paints



**Low Viscosity (LV)** to evenly disperse stains, sealants and toners



**Waterborne (WB)** to produce an even build of water-based paint

### Included with Merkur® Pump Packages

Paired with PerformAA air assist and airless spray guns, Merkur pumps can improve productivity, reduce costs, and provide consistent, high quality finishes.



**Phone: 1-800-6380-4410**

**Email: [Info@grapekbates.com](mailto:Info@grapekbates.com)**

1564 Main St, Suite 502, East Earl, PA 17519 • 318 Elm St. Westfield, NJ 07090 • 26 Clinton Dr. Hollis, NH 03049 • 2221 S. Clark St. Arlington, VA 22202

An Authorized Graco Finishing Equipment Distributor



## SOLID AS A ROCK.

Dependable, even-keel, there-when-you-need-it, power. DynaQ™ gensets.

Steady as a clock.



717-354-3322 • [hoovertec.com](http://hoovertec.com)





PONY PEDAL CART



PONY CYCLE

CALL FOR PRICING

GREAT CHRISTMAS GIFTS



ON THE GO EMERGENCY TOOL KIT

MOHAWK VALLEY COACH SHOP

1815 FORDSBUSH SPUR ROAD  
FORT PLAIN, NY 13339  
315-823-2053



Gehman Accounting™  
Inspiring Confidence™

Is the burden of bookkeeping defeating your ambition?



Get in touch with us.

717.354.8288 • www.gehmanaccounting.com  
office@gateam.com

# BLIND STAPLER

WWW.BLINDSTAPLER.COM



**...FAST ...EASY ...EFFICIENT**

**Eliminates** the need to **face nail** and **pocket screw** a cabinet face frame to a cabinet box. The face frame is affixed quickly and securely.

This **PATENTED DESIGN** allows a standard narrow crown staple to be shot diagonally, underneath the cabinet face frame into the cabinet box.

The **BLIND STAPLER™** will never leave a mark, so every cabinet **can be pre-finished before assembly!**

CONTACT STUART | PHONE: (434)454-0088 | EMAIL: STUART@BLINDSTAPLER.COM | WWW.BLINDSTAPLER.COM



### The BLIND STAPLER™

The **BLIND STAPLER™** is a pneumatic staple gun that allows for fast, easy, safe assembly of the cabinet face frame to the cabinet box.

- ✗ Broken Screw Driver Tips
- ✗ Driver Drill Slippage
- ✗ Cabinet Marring
- ✗ Pricked Fingers



### Small Cabinet & Drawer Tool

Specially designed to fit in small openings of face frames to cabinet box.

Allows fit into drawer opening and cabinet boxes as small as 4 1/2"



### Spacer Disks

Custom-made spacer disks allow perfect alignment of different size overhangs of the face frame over the cabinet box.

Size options available up to 7/8"  
Sizes vary by 1/32"



Christmas is not a time nor a season, but a state of mind. To cherish peace and goodwill, to be plenteous in mercy, is to have the real spirit of Christmas.

~Calvin Coolidge

# TRAVEL TO OTHER COUNTRIES . . .

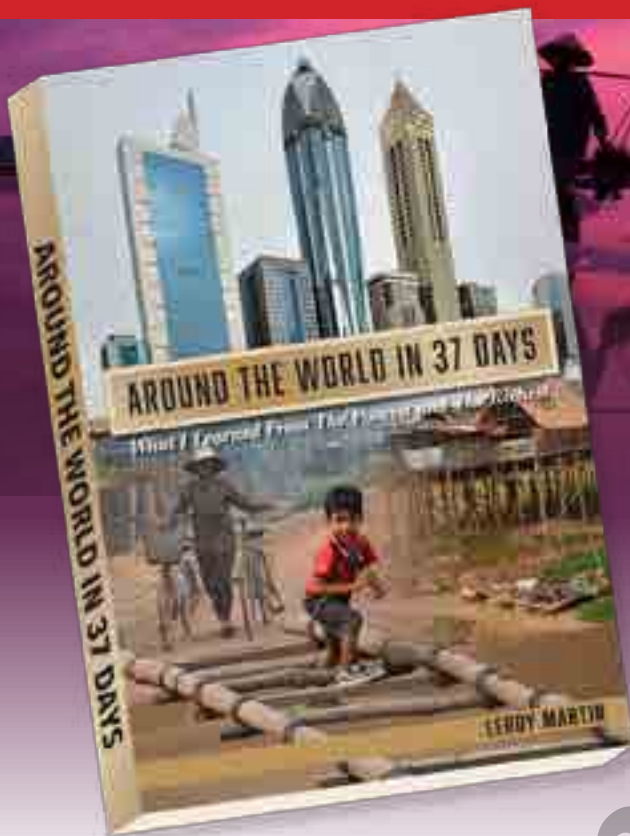

**AROUND THE WORLD IN 37 DAYS** — 272+ pages, with more than 400 full color photographs complete with detailed captions.

While reading this book, I found it very interesting to learn of the many ways in which people make their living who have a lot less than we Americans. Floating farm markets on the Mekong River, where the buyer and seller would conduct their transactions from their small boats. Repairing garments while sitting at a sewing machine beside the road. Using hand cranked, smoky generators to make espressos, to training camels for racing in the Dubai desert, is naming a few. Speaking of camel racing takes us to the glistening city of Dubai where we ride the elevator to the top of the world's tallest building. The excessive lifestyles the Dubai city offers the rich tourists is a stark contrast from the poor people in Southeast Asia. We learn that, despite the struggles of the poor to make a living, they still have a smile to share with a stranger. I find that there is much to learn from other humans around the world and lest we forget, let's remember that God created every one of them.

**EUROPEAN EXCURSIONS** — 270+ pages, with more than 300 full color photographs complete with detailed captions.

Riveting accounts of Leroy's solo adventures while traveling to 19 countries in Europe will transport you from your armchair to the seat of a Venetian gondola, an ancient Roman Colosseum, as well as a Belgium dungeon where early Anabaptists had suffered for their faith. The author also takes readers on a brief tour of the Nazi labor/extermination camps at Auschwitz-Birkenau in Poland and enjoys both a dogsled and reindeer ride at the Arctic Circle, deep within the forests of Finland. A brief visit to a hotel (and restaurant) which are both constructed entirely of ice and snow is certainly a memorable moment. Embark on a European adventure as you follow along in this fast-paced book.



**SHIPPING PRICES DO NOT REFLECT RATES FOR CANADIAN ORDERS.**

RETAIL ORDER FORM	QUANTITY	AMOUNT
EUROPEAN EXCURSIONS	\$15.99 each X	
AROUND THE WORLD IN 37 DAYS	\$13.99 each X	
	<b>SUB-TOTAL</b>	
	<b>S&amp;H</b>	<b>\$3.50</b>
	PA Residents add 6% Sales Tax	
	<b>TOTAL</b>	

Name: \_\_\_\_\_

Address: \_\_\_\_\_

City: \_\_\_\_\_ State: \_\_\_\_\_ Zip: \_\_\_\_\_

Order from:

**LEROY MARTIN** - PO Box 159, Denver, PA 17517  
**No Credit Card - Orders must be prepaid by check.**

**WHOLESALE INQUIRIES - Contact: 484-901-9671 or Email: atw37book@yahoo.com**



# TAKE ADVANTAGE OF THIS OFFER AND RECEIVE 36 ISSUES OF PCBE!

## OR SEND A GIFT TO SOMEONE SPECIAL



### GIVE A GIFT THAT GIVES THROUGHOUT THE YEAR

USE FORM TO SUBSCRIBE TO THE **PCBE**  
PLAIN COMMUNITIES BUSINESS EXCHANGE

*Check out our Great Rates!*

First & Last Name: \_\_\_\_\_

Business Name: \_\_\_\_\_

Street Address: \_\_\_\_\_

City: \_\_\_\_\_ State: \_\_\_\_\_ Zip: \_\_\_\_\_

Phone: \_\_\_\_\_

Occupation: \_\_\_\_\_

Card Holder's Name (print): \_\_\_\_\_ (signature): \_\_\_\_\_

Credit Card Number: \_\_\_\_\_

Expiration Date: \_\_\_\_\_ CVV: \_\_\_\_\_ Zip Code: \_\_\_\_\_

- REGULAR RATE**
- 1 year at \$25.00
  - 2 years at \$40.00
  - 3 years at \$42.00
  - 5 years at \$75.00
  - Receive most recent back issue...\$7.00

**Canadian Rates - US Dollars**

- 1 year at \$45.00
- 2 years at \$80.00

- PAYMENT METHOD**
- Check
  - Cash
  - Credit Card

P.O. Box 520, Millersburg, PA 17061 | Phone: 717-362-1118 ext. 3 | Fax: 717-842-6964  
 Email: [subscriptions@plaincommunities.com](mailto:subscriptions@plaincommunities.com)

2112 PCBE

*Duplicate this form to subscribe for additional people.*

**MISSION STATEMENT**

Our mission is to provide plain communities with Kingdom-focused business teachings and helpful connections through a monthly print magazine.



Variobend USA  
Double Folder

- > Revolutionary Silt-Frei 2-way post cut slitter. Widen the bottleneck in your trim operation!
- > Servo drive technology; highest precision and speed at minimum noise level!
- > Hardened tooling on clamping and bending beams.
  - > Massive 28" jaw opening for ease of access.
  - > Servo drive ballscrew gripper backgauge.



Slinet

The next generation in coil processing.

- > Up to 8 fully auto-adjusting slitting knives.
- > 4 roll automatic straightener unit.
- > Modular coil storage system. Customize to your needs.
- > Optimizer software that organizes your jobs for max efficiency.



INFO@HERSHEYSMML.COM  
TOLL FREE: (877) 289-3030  
420 PROGRESS DR. MARYTON, IL 61938

Speed. Accuracy. Service.

Don't just bend trim- Variobend it! Call today!



**Trojan TRACKS** **BRIDGESTONE** **camoplast soliddeal** **TNT**

**PROWLER**  
EXT Pattern

**SUMMIT SUPPLY**  
ZigZag Pattern

**GRAPPLE**

**AUGER**

**LOADER BUCKET**

**BALE SQUEEZER**

**ROTARY TILLER**

**CID: HEAVY DUTY PALLET FORKS**

**CID: BRUSH CUTTER**

**TNT**

**MANY MORE ATTACHMENTS AND TRACKS AVAILABLE**

**C Pattern**

**Multi Bar Pattern**

**BD Pattern**

**Block Pattern**

**JOE WELDING & MACHINE**

We accept major credit cards.

**VISA** **MasterCard** **DISCOVER**

6970 US Hwy 68 | Mayslick, KY 41055 phone: 606.206.0503 fax: 606.763.9518

**Gehman Accounting™**  
Inspiring Confidence™

**Valuable Insight.**  
The best insight comes from a combination of—

- ✓ Quality Education
- ✓ Business Experience

**Our team has worked hard to have both.**

717.354.8288 • [www.gehmanaccounting.com](http://www.gehmanaccounting.com)  
office@gateam.com

**Contact a Dealer Near You!**

**Enos Kurtz**  
Luthersburg, PA  
Ph. (814) 553-2994

**United Fencing**  
Apple Creek, OH  
Ph. (330) 857-1543

**Nittany Feeds**  
Mill Hall, PA  
Ph. (570) 927-2720

**Austin Raber**  
Montgomery, IN  
Ph. (812) 486-5974

**Country Garden Farm Supply**  
Mifflinburg, PA  
Ph. (570) 966-3944

**Timberview Welding & Sales**  
Drakesville, IA  
Ph. (641) 722-3100

**Diamond Harness & Sales**  
Nappanee, IN  
Ph. (574) 773-5454

**Trail Farm Supply**  
Millersburg, OH  
Ph. (330) 893-3086

**JB Enterprises**  
Mio, MI  
Ph. (989) 826-8024

**FEED BUDDY**  
ALUMINUM FEED BINS

**Designed and made by:**  
**Double Oak Enterprises**

7396 W Moore Rd.  
Nappanee, IN 46550  
Ph: (574) 354-8573

**3 SIZES**  
500  
400  
200 lb.  
Capacity

**Only 56" & 58" High**

# Developing Employee Compensation and Benefits

SAM YODER

What keeps people motivated to continue coming to work for you? Or what makes them seek out other employers? How much of their decision is based on pay? How much is based on the environment, or the hours? Or the relationships? Or the monotony? How about vacations or benefits? What is fair? What is generous? What is unreasonable? As employers we wrestle with these questions. While I don't have all of the answers, I'll share some of the things we've tried and learned at Berlin Gardens over the past forty years.

First, we take the Bible seriously. The Bible has a lot to say about paying wages. For example, in the Old Testament law, God told the children of Israel, *"Thou shalt not oppress an hired servant that is poor and needy, whether he be of thy brethren, or of thy strangers that are in thy land within thy gates: At his day thou shalt give him his hire, neither shall the sun go down upon it; for he is poor, and setteth his heart upon it: lest he cry against thee unto the Lord, and it be sin unto thee."* (Deuteronomy 24:14, 15) The point is, pay your hired help a fair and generous wage.

In an example from the New Testament, Paul said, *"Masters, give unto your servants that which is just and equal; knowing that*

*ye also have a Master in heaven."* (Colossians 4:1)

In a modern-day application, the servants are the employees, and the masters the employers. James also warned, *"Behold, the hire of the labourers who have reaped down your fields, which is of you kept back by fraud, crieth: and the cries of them which have reaped are entered into the ears of the Lord of sabaoth."* (James 5:4) These passages underscore that God pays attention to how we pay our employees.

## **Employee compensation**

There are three basic types of compensation you may pay to those who work for you. *Direct compensation* is based on an hourly rate or a fixed price for the amount of work completed.

*Indirect compensation* is usually paid as a bonus at the end of a month or year and might include profit sharing as well. *Non-monetary compensation* includes benefits such as paid vacation, health insurance, flexible hours, opportunities for growth and advancement, and virtually any sort of reward not given in the form of money.

Market wages are the average wages paid for the level of work performed. Market wages vary among industries and across geographic regions. As an employer,



Image Credit: AP911\_Studio/Shutterstock.com



*“Thou shalt not oppress an hired servant that is poor and needy, whether he be of thy brethren, or of thy strangers that are in thy land within thy gates: At his day thou shalt give him his hire, neither shall the sun go down upon it; for he is poor, and setteth his heart upon it: lest he cry against thee unto the Lord, and it be sin unto thee.” ~Deuteronomy 24:14, 15*

you should know what is normal for the community where you operate your business, because employees expect at least average wages. Keep in mind that market wages may not be a good benchmark of what is fair and generous. Employers driven by greed contribute to lowering market wages.

Proverbs 24:3-4 emphasizes that any enterprise is built by wise planning. *“Through wisdom is an house builded; and by understanding it is established: And by knowledge shall the chambers be filled with all precious and pleasant riches.”* Wise planning is not only using common sense, but also knowing and keeping abreast of facts related to your industry. It is easy to find market wages if you have internet access at home or in a library. If you don't have access, ask someone who does. In the United States, the average median income is \$53,891.

In Holmes County, where Berlin Gardens is located, the average is \$45,000. We don't try to compete with Cleveland or New York City, but we know we cannot expect employees to continue working for us if we do not pay them at least average market wage.

Your employees are constantly aware of other opportunities, and it is not unreasonable for them to go elsewhere for higher wages. Another thing to consider is whether published median income is based on both husband and wife working or on a single wage earner. This makes a difference in how much your employees can expect as a market wage.

The bottom line is that if you want to be fair and generous, you need to avoid paying below market wages. If your *direct compensation* is competitive and generous, then you can

use *indirect* and *non-monetary* compensation to give your company an edge—an extra reason for your employees to stay with you. Following are some of the *indirect* and *non-monetary* compensation we have implemented to give our employees an advantage, and reasons to remain with us.

#### **Monthly bonus plan**

Our monthly bonus includes putting a certain percentage of total sales into a kitty. We tell our employees at the beginning of the month how much the kitty contains. The cost to correct any mistakes during the month, such as orders written wrong, shipping errors, holes drilled wrong, or using incorrect colors comes out of the kitty. Once the costs of all the mistakes are covered, the remaining funds are split equally among the employees at the end of the month.

---

**Wise planning is not only using common sense, but also knowing and keeping abreast of facts related to your industry.**

---

For example, if there is \$5,000 in the kitty at the beginning of the month and there are five employees, each employee would get \$1,000 at the end of the

month. But if mistakes cost \$2,000 then that money comes out of the kitty, leaving only \$3,000 left to split with five employees. It is surprising how much motivation that monthly bonus spurs. At month end, we compile a list of the mistakes, their cost and the department where the mistakes were made. The employees appreciate the extra cash and help us resolve the issues that were causing mistakes.

#### **Birthday news**

Another benefit we offer is a monthly newsletter listing everyone's birth date. For their birthday, employees get a

*Anabaptist Financial - Continued on Page 40*

paid vacation day. The only catch is that they have to write an article for the newsletter chronicling how they used their day off. It is quite interesting to read about their various activities. You would be surprised how much earlier people are willing to get out of bed to watch birds rather than making furniture!

### **Company picnics, banquets and outings**

Each summer we invite all the employees' families to a company picnic where there are gifts for the children, door prizes, softball games, a cookout and other activities. In the fall we take a bus trip, generally within our home state of Ohio. We begin with breakfast at a restaurant, then tour a business or factory, go for a hike, attend an event and eat another meal, all paid for by the company. And of course, we provide a Christmas banquet in December. In the spring, I call the local restaurant Boyd and Wurthmann and order mashed potatoes and their seasonal specialty, dandelion gravy for everyone.

I also like to do smaller surprises such as walking through the shop with a bag of beef sticks or ice cream sandwiches and thank our employees for their work. You should see the smiles! These gestures, large or small, are a form of compensation, and the employees appreciate the benefit of participating in them.

### **Employees leave people**

As you consider ways to provide compensation and benefits, it is important to understand why employees leave the companies they work for. Are you aware that employees don't actually leave *companies*? They leave *people*. According to research that included a million interviews, they choose to leave for reasons that have everything to do with human beings, not with a company or organization. They gave five reasons:

1. The boss is a micro-manager and does not trust them.
2. They are bored and unchallenged, doing the same thing over and over.
3. Tense relationships with coworkers, a major reason.
4. Getting blamed for mistakes.

Did you know that most of the time mistakes are the fault of the *process* and not the fault of the *individual*? (source: Dustin Hostetler, Flowtivity.) Study the history of your accidents and you will find it is true.

5. Work isn't flexible. Three strikes and you're out.

Try to be accommodating, particularly for key people such as your managers. This is not always easy, but I have given my managers the liberty to leave once their work is done. They are on salary, so I tell them that as long as I am not getting complaints from their department, and they are not asking me questions, I will give them the flexibility to adjust their hours within reason. But I ask for clear communication: if you're going to be at work only part of the day or not at all, make sure we are aware of your absence.

In addition, we sometimes allow all employees to go home if we've met our quota for the day. For example, when we do inventory we sometimes get done early, but we'll pay everyone for a full day and send them home.

### **Why managers quit their bosses**

Among the foremost reasons that managers quit are that they are overloaded, the boss doesn't give managers leeway to make their own judgment calls, or the boss runs terrible meetings.

Have you ever been in a meeting where people are yawning and falling asleep? This means the meetings are too long and not adding value. One solution is to

forgo chairs and have "stand up" meetings. The tendency to be lengthy or irrelevant decreases because everyone is standing.

### **Share the five-year strategy**

In addition to defining our core values, one of the best things we've done as a company is include our key people in the development of our five-year plan. We asked our key people, "What is our company going to look like in five years?" The only stipulation was that no one would be allowed to criticize anyone else's ideas. No idea was rejected, and soon one wall of our meeting room was covered with suggestions, 117 of them, to be exact. These ideas were grouped into themes, and individuals were chosen to "champion" each particular category. Now every two years we meet to see how nearly we are meeting the five-year strategy.

Including your managers and staff in these plans is important. Choose key people to help plan but keep everyone informed. When employees feel like a company has a plan and is going places, they are more likely to stick around. Working for a

---

Are you aware that employees don't actually leave companies? They leave *people*.

---



company that is making progress and will still be around in five years is a benefit.

### **Be a gardener**

Jack Welch ran General Electric for twenty years, and when he retired he was the highest paid CEO in the United States. Under his leadership, GE's net value increased four thousand percent! He once remarked that he considered himself a gardener. "I water and provide nutrients for 750 top executives. That's my most important job." He did not become a success by walking through the plant barking out orders and demanding higher production. He became successful by taking good care of the people who managed the production.

### **Those who don't know, don't know they don't know**

A man once related how a five-year old told him his nose is ugly. Surprised, he defended his nose, but she insisted. Curious, he went home and examined his nose in a mirror. Sure enough, he had an ugly nose. He didn't even know that he didn't know, but now that he did know, he was self-conscious about it.

What the girl did was not especially nice, and sometimes ignorance is bliss. But where things really count, a girl who speaks as bluntly as she did is doing us a favor. Your employees will be that person for you, if you'll invite feedback. You would be surprised at the things you are overlooking. Consider King David in the Bible. If he could write beautiful poetry and rule a kingdom, yet be deceived in a matter as significant as murder and adultery, imagine what we may be overlooking in our businesses! Like David, we must search our hearts and allow others to help reveal our blind spots.

Your employees must feel it is safe to give this kind of feedback. A businessman from Texas made a rule that for one year, when an employee came to talk with him in his office, he would not make any excuses or say anything in his own defense. This gave them freedom to speak out without fearing they might lose their job. The businessman said on some days he went home feeling like a whipped puppy, but it was the best thing that ever happened for his company.

Another option is to ask each department to fill out evaluations of the company. Take your lack of self-awareness seriously.

### **Meet the basic needs**

Did you know that McDonald's has an employee turnover rate of 135% annually? And that's low! It's been as high as 300%. Chick-fil-A, on the other hand, is a fast food restaurant with a turnover rate of only 35%.

## Among the foremost reasons that managers quit are that they are overloaded...

We once took our whole management team to a Chick-fil-A for a meeting just to experience the customer service. Chick-fil-A is currently the fastest growing restaurant chain in America. One of the benefits of working for them is their reputation for service and their constant growth. Employees feel good being a part of that. But Chick-fil-A also offers other benefits, such as helping to pay college tuition if you work for them for more than a year.

Chick-fil-A's corporate purpose statement is "To glorify God by being faithful stewards of all that is entrusted to us. And to have a positive influence on all who come into contact with Chick-fil-A". I believe their commitment to bringing glory to God and caring for people is why they thrive. Your employees want respect. They want to be part of a plan. They want fair compensation, and they want stability.

*Anabaptist Financial - Continued on Page 42*

**MOM'S LAUNDRY HELPER**  
**Mega SPINNER**

**\$339<sup>00</sup>**  
Electric

**Only takes 150 watts to Run**

- 20% Bigger than traditional spinners
- 6Ah DeWalt or Milwaukee, runs 10+ loads
- Removes up to 80% of water from clothes
- Fully serviceable with 1 year warranty

**Available in 12v, Air, Cordless and Electric**  
**Cordless DeWalt, Milwaukee, Makita Available**

**Dealer Inquiries Welcome**

**MEGA JR**

- Regular size capacity
- Compact size
- high RPM spinning
- 1 year warranty

**\$229<sup>00</sup>**

**Schlach**  
ENGINE

**330-698-0229**

**Take care of your property**

Another benefit to your employees is an attractive, clean environment to work in. One of our employees is a young

**Your employees must feel it is safe to give feedback.**

Amish girl who loves to clean. That's all she does, five days a week. She gets many

compliments from the employees about the sparkling clean restrooms and lunchroom, and tidy flower beds. Even these details make an impact on your employees.

**Plan for retirement**

A final suggestion is to develop a savings plan for your employees. Many people are not saving for retirement. One way to do this is through a Simple IRA, which provides a tax-deferred retirement account to which your company may also contribute. More and more employees are beginning to expect a retirement plan as part of the compensation.

**Conclusion**

In the end, whether it is *direct, indirect, or non-monetary*, fair compensation and benefits are a key attraction that will keep your employees with your company for a long time. Fairness is also a principle taught and commanded in Scripture. As individuals, we are to be salt and light to the world, and our companies should be the same. We should be known as business owners and managers who treat our employees fairly, even generously, remembering that as "masters," we also have a Master in heaven.

*Sam Yoder is the owner and president of Berlin Gardens, a respected outdoor furniture company in Berlin, Ohio. He is also a pastor at Gospel Haven Mennonite Church.*

Article reprinted with permission from Anabaptist Financial. For more business resources, call or write to request our free catalog: Anabaptist Financial, 6834 County Road 672 Ste 201, Millersburg OH 44654; Phone: 570-800-2191. Or visit [www.afweb.org/resources](http://www.afweb.org/resources).

**ATTENTION DEALERS!**

Great profit margins! A nice addition to sell with your Honda or Yamaha generators.

**SMART START**

An electrical system designed to automatically start & stop your generator upon demand via water pressure switch, low battery start, thermostat, on/off, etc



- Auto Start boxes for Yamaha and Honda EU 7000 are entirely preset, equipped with a plug-in.
- There is NO additional wiring required on selected models!
- Systems are equipped with an auxiliary port to plug in low battery start in 12, 24, or 48 Volt battery packs.

*We also stock the low battery start by Miller Circuit that plugs directly into the Smart Start.*

Ask about our Smart Start kit for the Honda 5.5hp. Includes a choke solenoid and run sensor for accurate start-ups. Only 4 wires and 3 linkages to hook-up. Includes instruction manual.

**ATTENTION SOLAR INSTALLERS**

Our Low Battery Monitor has precise adjustments for any size battery bank (including Lithium) and simply plugs into the Smart Start. This unit can also be used on any 2 wire auto-start with only 1 modification.



*We also build Custom Auto Starts to your specs!"*

**ASK TO BECOME A DEALER. Generous profit margins.**

Manufactured by: **Falcon Engine LLC**  
DARYL BONTRAGER | 574-642-4353 | 66780 CR 33, GOSHEN, IN 46528

Spoon River Sharpening	217-336-4045	IL	Liberty	Miller Sales	269-432-2008	MI	Centreville	SSD3XEF63	Smart Start for Yamaha EF6300 Inverter MSRP \$515.00
JDK Wholesale	812-486-6768	IN	Odon	Millers General Repair	989-386-7564	MI	Clare	SSD3XEM5	Smart Start for Honda EM5000SX MSRP \$ 570.00
Reliable Power	574-858-9250	IN	Bourbon	Quality Engine	231-924-6707	MI	Newaygo	SSD3XEU3	Smart Start for Honda EU3000 is (Sold as a kit includes choke solenoid and plug) MSRP \$ 585.00
Solect Energy	260-499-3051	IN	Lagrange	Yoders Engine Repair	No Phone	NY	Fillmore	SSD3 XEU65	Smart Start Honda EU6500 MSRP \$ 550.00
Schmucker Motor Repair	260-705-4173	IN	New Haven	Dutch Lane heating and Sales	330-465-2347	OH	Apple Creek	SSD3XEU7	Smart start for EU70013 MSRP\$490.00
Innovative Heating	260-768-7806	IN	Shipshewana	Bylers kiln Drying	330-469-7473	OH	Middlefield	SSD3XEU7BT	Smart start for EU7000 is Bluetooth comparable MSRP \$ 490.00
Wellspring Components	260-768-7336	IN	Shipshewana	WL Solar/ Yoder Lighting	440-228-7730	OH	Middlefield	SSD3XEU7PT	Portable smart start for EU7000 w Bluetooth MSRP \$ 450.00
County Line Carraige and Solar	260-238-4360	IN	Spencerville	Premier Lawn and Garden	330-674-1376	OH	Millersburg	SSD3XGHON	Smart Start for Honda engines Includes choke, choke bracket and run sense kit MSRP \$ 585.00
Spectrum Energy	260-350-0089	IN	Syracuse	Shelter Solar	937-217-9006	OH	Winchester	SSD3XP4500	Smart Start for onan P4500 MSRP \$585.00
Miller Power Enterprises	260-768-7002	IN	Topeka	Ray Zehr	519-773-2218	ON	Aylmer	SSD3XP9500	Smart start for Onan P9500 df MSRP \$ 550.00
Trager	574-354-7696	IN	New Paris	Georgetown Hydraulics	610-593-2753	PA	Christiana	SSD3X555	Yamaha smart start MSRP \$ 535.00
Advanced Solar	574-227-2801	IN	Warsaw	Tri Z Power	717-492-7119	PA	Lykens	SSD3X160	Smart Start Honda GX 160. Includes choke choke bracket, and mounting hardware kit MSRP \$ 585.00
Knepps Battery Sales	812-698-3993	IN	Washington	Mountain View Farm Supply	814-349-8386	PA	Rebersburg		
Cub Run Engine and solar	270-524-3944	KY	Munfordville	David Gingerich	608-839-7353	WI	Soldiers Grove		



# Dust-Pro DOWNDRAFTS

## Dust-Free Sanding

1 HP 1725 RPM Motor  
110V Plug In  
Durable Coated Tops  
Rubber Bumpers Reduce Vibrations  
Double Locking Casters  
36x48 or 36x72 Sizes Available

1 Year Warranty  
Customer Satisfaction  
Guaranteed



Easy Access Filter Tray



Available in Lineshaft

Light & Stand Combo  
sold separately



### DEALERS:

Alpha Building, Shipshewana, IN  
260-768-4410

A. W. Machinery, Apple Creek, OH  
330-778-0020

Custom Wood Products, New Holland, PA  
717-354-7578

Keim Lumber, Charm, OH  
330-893-2251

Miller & Sons Metalworks,  
W 2865 Carter Road, Markesan, WI 53946

Kevin Bontrager  
Ph: 574-825-1108 • Fax: 574-825-5390

Dealers Welcome

## Come work for LancasterPuppies.com!

Exciting Photographer or Office Position, Full or Part Time. Great Pay, Driving Bonus and Benefits with Full Time. Become part of our team!

Looking for applicants in:  
Pennsylvania, Ohio, and Indiana.

Computer and camera experience is a plus, but willing to train the right candidates.

Call Leon at 330-275-2516 or  
E-mail: [BuckeyePuppies@gmail.com](mailto:BuckeyePuppies@gmail.com)  
Fax 717-255-0300



# HIGH EFFICIENCY INFRARED HEATERS



**A Name Brand YOU Can Depend On**

Replace your old torpedo heater, and enjoy the clean and comfortable sunlight warmth of VAL6, plus fuel savings that will quickly pay off your investment. VAL6's near perfect combustion system produces almost no smoke or smell while running and is CSA certified for indoor or outdoor use!



Available in Diesel Fuel, Propane, or Natural Gas Models... Call for pricing and brochures.

**GEORGETOWN**  
**SALES LLC**

375 Old Dam Road  
Christiana, PA 17509  
610-593-5193

Ask for our FREE catalog  
featuring 80+ models of  
propane and natural gas heaters.

## Green Forest Soaps and Salves

### Liquid Hand Soap

Transforms Dried, Dirty  
Hands to a Clean, Soft Texture



Homemade Hand & Body Wash

### Bath Salts

*Bath Salts*  
{benefits of bath salts}  
stress relief, reduces muscle  
and joint ache, improves  
circulation, improves skin  
hydration, and so much more!



*Arnica Salve*  
Arnica is a mountain plant whose  
properties have been known for  
centuries. It is well known for  
helping sore muscles and injuries  
heal faster.

### All natural oils and salves



*Garlic Salve*  
use to relieve respiratory issues  
such as sinus infection, chest  
congestion & sore throat, also  
good for ringworm, warts, tumors  
and more.

*Chest Rub*  
use for chest congestion, coughs,  
pneumonia, & other discomforts.

Mix Mullein & Garlic Oil  
together for a powerful  
ear infection remedy...

## Stay Healthy The Natural Way!

Call for a FREE catalog – phone: 717.806.0475 • fax: 717.786.8621  
913 Georgetown Road • Paradise, PA 17562

The world has grown weary through  
the years, but at Christmas, it is young.

~Phillips Brooks

## **Building owner testimonials:**

*Shane, told us we were over 25% less money to restore his store roof, then it would have cost him to remove and replace his roof and we didn't affect his business in any way because we were able to get on and off the roof from the back side.*

*It took 5days from start to finish. And throughout the entire process, beings we restored the existing roof it was never uncovered and in Danger of a rainstorm ruining things on the inside.*

## **Roof project from 2020**

*Jeff is the manager of the building maintenance for a large truck sales company, he contacted us about a 60,000sq.ft. roof project he needed to have either replaced or completely restored. We gave him an estimate on both systems, one removing the existing roof material to the deck and installing a brand-new roof and one doing a complete restoration system of the existing membrane.*

*Jeff also got several other quotes from other contractors and figured out that for the most part his restoration quotes were half the cost of the complete roof replacement.*

*We were awarded the project and were able to give him a seamless, waterproof system, without interfering with their day-to-day business.*

*Started with installing these roofs in 2012 adding it to our existing roofing/construction business, starting out I wasn't sure if this would work for us, so we were very cautious. The first year we did several projects and decided we wanted to do more the following year to check it out more and see if it really would worked like we were told. Our business has grown every year since. The last 7 years we have only done these systems having completely quit our existing residential business.*

*Today we own and operate a family business, we have more fun as a family and in our business than we would ever have dared hope for.*

*I started installing commercial roof restoration systems in 2016, that first year I worked hard getting my name out and by the end of the year we had made over \$100,000 in net take home income. Our business has grown every year since and today I am able to work from home a lot more than I ever dreamed possible with other people in place to manage projects and do roof installs. Looking back the hardest part was making the decision to start, stepping away from a steady paycheck into something I wasn't familiar with.*

*What I know now is with the support from this group of contractors, from advertising, roof inspections and then doing the actual roof projects. That is what made the big difference.*

*This has made a huge difference in our income, has allowed us to buy a farm and spend more time together as a family.*

*From The Midwest*





# Contractors

## HOW CAN 2022 BE BETTER?

### *CHANGE YOUR GAME*

- 10 Commercial roofs = more profit than 25 residential roofs
- With our systems 2 - 3 man crew generates more profits than 8 - 9 man crew doing general construction.
- Building a profitable business, builds a better life for your family.
- Someone will be doing these projects, why not you?

## HOW DO I KNOW THIS IS FOR ME?

1. I am a person of integrity.
2. I am serious about business and willing to work hard.
3. I have a goal of building a solid, successful business that will stand the test of time.

***END OF THE YEAR SPECIAL***  
***Call Now To Receive 30% Off Our***  
***New Roofer's Marketing Kit!!***

***Call today for:*** list of potential buildings in your area, product samples or more info: **855-222-0288**

***Midwest Roofers Alliance***



# Gear Up for Colder Weather

Calf Jackets, Boots and More!



(800) 845-3374

**FARMER BOY®**

FarmerBoyAg.com

Parts You Need.  Brands You Know.  Prices You Can Afford.

## Laundry Maid Spinner BETTER BY DESIGN

- Stainless steel construction
- Improved brake system
- Electric or battery models
- Quick ship available



Call: 330.893.3033  
4741 State Route 557  
Millersburg, Ohio 44654

## Power Your Wringer Washer & Leave the Exhaust & Noise Outside.

- Available in lengths 4'-15'
- 2-year warranty
- Collet nut engine connection
- All parts are replaceable



Do your laundry in peace while keeping your home free of harmful fumes.

This quiet, smooth running flexshaft is quick and easy to install and connects to your engine with a collet nut.



Call: 330.359.0330  
2310 US Route 62  
Dundee, Ohio 44624



LOOKING TO START YOUR OWN BUSINESS?

We are looking to form partnerships in various areas with contractors to install our roof systems.

HELP YOUR PROFITS GO THROUGH THE ROOF!



**30-40% PROFITABILITY WITH RESTORATION**



**LOW START-UP COSTS**



**LEARN FROM EXPERIENCED ROOFERS**

If you are an independent roofer, have a crew of roofers, or are looking for a new career path, call us today. Our proven commercial roof restoration system will help you build your profits and your business.

Full training program available for business startup and product install. Not certified? We can help with that, too!

**Call before Christmas to receive a FREE demo kit! (\$500 value)**

Hawkeye Roofers Alliance has commercial roofing projects now and is looking for crews or individuals.

**Call us today at 855-527-2842**  
to see if your area is available!





# BUY 1 GET 1 FREE!



Limited to 6 canisters plus 6 FREE (12 canisters total) per family.  
Special Offer Ends December 31, 2021

## BRAZILIAN BLEND

### New Brazilian Blend Coffee with Ganoderma + Digestive Enzymes

Now Available  
in Stick Packs

### ARE YOU SENSITIVE TO COFFEE?

Our new smooth tasting Brazilian Blend coffee includes Digestive Enzymes which may help soothe your stomach if you're sensitive to coffee. Coffee is naturally acidic which is the reason many people may have a problem digesting it.

This new Brazilian Blend coffee also includes Ganoderma which may boost your immune system while also helping to decrease your sensitivity to coffee. This coffee is a blend of high quality Brazilian and Colombian coffee powder plus Digestive Enzymes and Ganoderma. Take advantage of this limited time Buy 1 Get 1 Free deal today!



Brazilian Blend  
Instant Coffee

<b>BRAZILIAN BLEND</b>	<b>BUY 1 GET 1 FREE</b>	
BRAZILIAN BLEND INSTANT GANODERMA COFFEE (30 Stick Packs)	<input type="checkbox"/> Buy 1 canister for \$29.00 and Get 1 FREE	<input type="checkbox"/> Buy 4 canisters for \$116.00 and Get 4 FREE
	<input type="checkbox"/> Buy 2 canisters for \$58.00 and Get 2 FREE	<input type="checkbox"/> Buy 5 canisters for \$145.00 and Get 5 FREE
	<input type="checkbox"/> Buy 3 canisters for \$87.00 and Get 3 FREE	<input type="checkbox"/> Buy 6 canisters for \$174.00 and Get 6 FREE

NAME: \_\_\_\_\_  
 ADDRESS: \_\_\_\_\_  
 CITY: \_\_\_\_\_ STATE: \_\_\_\_\_ ZIP: \_\_\_\_\_ PHONE #: \_\_\_\_\_

Shipping	FREE
<b>TOTAL</b>	

COUPON CODE: **PCBE**



PO BOX 127  
Millersburg, PA 17061  
(877) 278-1090

**FREE SHIPPING ON ALL ORDERS!**



# Blood Pressure Issues?

Looking for a simple and effective way to support healthy Blood Pressure?

Want to make sure that your heart gets all the support it needs?

Need an easy-to-swallow and convenient capsule that contains all the essential ingredients for heart health?

Rosemary was worried about her husband Chris... His blood pressure issues caused him to need a prescription drug- which neither of them were happy with.

And while it did help him better control his blood pressure it came with a variety of side affects such as lightheadedness and lethargy.

She wondered if a more natural product could be found...

One day she was chatting with her sister, and her sister told her about a dietary supplement called Blo-Pres that helped her husband better control his blood pressure.

Rosemary found out Blo-Pres had a long-list of helpful ingredients:

Vitamin C-Helps relax blood vessels that carry blood from the heart.

Niacin-Can have a positive affect on cholesterol and the hardening of the arteries.

Folate-May help improve blood flow.

Garlic Powder- Helps reduce high blood pressure.

Hibiscus Flower Powder- May help lower blood pres-sure.

Olive Leaf- May help lower blood pressure.

Hawthorn Extract- Can help dilate blood vessels.

Green Tea Leaf (decaffeinated) - May help reduce blood pressure.

There you have it-One ingredient after another that helps control blood pressure.

"I've been using a natural supplement instead of what the doctor prescribed for high blood pressure. I showed the bottle to

the doctor. The doctor looked at what my blood pressure was and said, "I would recommend to keep taking it." - Roger

"I was having some minor issues with my blood pressure and looked for a way to better control it. I came across this natural product and for the price, I decided to give it a try. Within a week or so, I was seeing improved results and now, after a couple months, my blood pressure is where it should be." -Ruth Ann

"This supplement has been a blessing! I had been taking a prescription medication for my blood pressure for a long time and it created a variety of side affects like light-headedness, always being tired, indigestion, no energy and more. I started your prod-uct and I must say I can tell the difference. I will continue this and hopefully it will maintain my blood pressure for a long time to come." -Ethan

Each bottle of Blo-Pres contains 90 easy-to-swallow capsules and is considered a one-month supply. The product is made in a FDA registered facility in the US.

You can get a bottle of Blo-Pres for \$29.95 including free shipping and handling. Or get two bottle of Blo-Pres and you'll be given a third bottle absolutely FREE. PLUS, you'll get FREE shipping and handling. Simply send payment to MWSB Inc., 834 South Union Street, Olean, New York 14760-3917, or call 888-762-5477 to order.

Blo-Pres comes with a 30-Day money-back guarantee.

These statements have not been evaluated by the Food and Drug Administration. This product is not intended to diagnose, cure, or prevent any disease. Results may vary.



**Gehman**  
Business Advisors™  
Inspiring Confidence™

Find community  
in business  
with a team  
by your side.

Connect with an advisor.

Guidance to transform your business

717.355.9723 • [www.gehmanaccounting.com](http://www.gehmanaccounting.com)  
[businessadvisors@gateam.com](mailto:businessadvisors@gateam.com)

Gifts of time and love are surely the basic ingredients of a truly merry Christmas.

~Peg Bracken

## How to make Constipation an irregular event

Dear Friend,

Imagine a life free of the feeling you get when you're unable to completely empty your bowels. A life free of fatigue and finally losing those extra pounds you've been carrying for years. You might be thinking, this just sounds too good to be true.

After helping hundreds of people with constipation and related issues over the past 21 years, we commonly hear statements like, "my mental alertness has improved," "my candida cleared up," "I don't awaken with toxic headaches anymore," and "I have twice as much energy!"

Maybe you've heard others say, eat more fiber, or you just need to eat healthier. But what does that really mean? What does that look like in real life?

We take a simple, educational approach to good bowel health.

Discover health secrets revealed by an Italian immigrant who amazed doctors around the world.

Claim your copy of the best-selling book "Cleansing the Body and the Colon for a Happier and Healthier You." \$8 value! Yours **FREE** when you mention code **PCBE1**.

Call Joy Thompson or Charlotte Thompson today for your **FREE** consultation at 614-209-6324 or 330-852-2967 or write to us at 10174 Pleasant Hill Rd. NW Dundee, OH 44624

Best hours:  
Monday-Thursday, 8:30am-4:00pm

RETHINKING RETIREMENT: A KINGDOM-FOCUSED VISION IN MIDLIFE AND BEYOND

# GOING Till You're Gone

Plain Communities  
Business Exchange

*Gary Miller*



## The “Right” to Retire — Chapter 14 of 34

One of my challenges is getting enough exercise. Most of my work must be done while staring at a computer, and consequently it is possible to forget to get outside and move around. To combat this tendency, I try to take regular walks. I set a timer to remind myself, head outside for a fifteen-minute walk, and then go back to squinting at the machine. But sometimes these fifteen-minute walks stretch into longer periods of time. And when they do, it's because of Spike and Jim.

Spike and Jim are two older men who live around the corner. They are healthy, retired, and bored, and getting past their houses can be a challenge. Spike is generally puttering around in the yard or garage looking for something to occupy his time. When I appear on the horizon, his eyes light up. In me he sees a diversion, something to focus on for a few minutes in the midst of another long day.

Jim, who lives just a few houses down from Spike, spends his day differently. He has a little retiree refuge set up in his garage, where he spends most of each day sitting in an older Lazy-Boy in front of a television. To his right, and within reach, is a small, well-stocked refrigerator so he can refresh himself in the middle of watching the ball game.

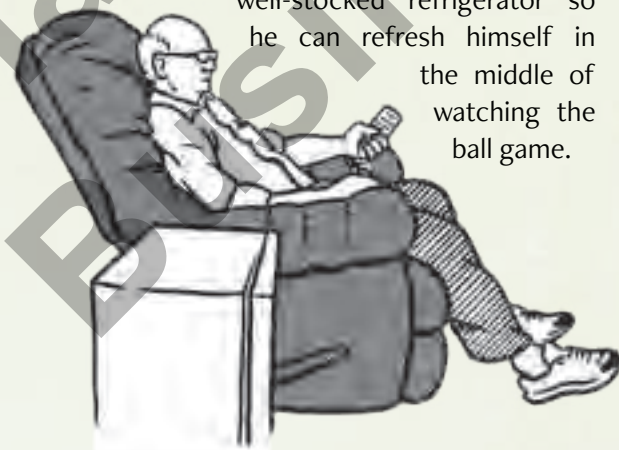

Jim's garage door is usually up in warm weather, and in my many walks past his house, his profile in front of the television has become a familiar scene. With a cold drink in his right hand and the remote in his left, Jim passes the day in his garage. Like Spike, he seems to welcome the diversion of chatting with me when I walk past.

Both Spike and Jim are living out the American dream. They have spent a good part of their lives on the job, longing for the day when they wouldn't have to work anymore. Now, after all those years of planning, hoping, and saving, they have finally arrived. They are at the pinnacle of their lives. Spike and Jim are retired!

In preparation for this book, I immersed myself in information regarding retirement. I read books, newspaper articles, and retirement planning guides. The sheer amount of information on the topic is astounding. Almost everyone, it seems, either is retired or wants to be. According to government figures, 38,385,000 Americans are over sixty-five and receiving Social Security benefits. And if the articles and books are any indicator, another 150 million Americans are going to work each day and eagerly longing for the day they don't have to.

Retirement has captured the imagination of the American people. Everyone, we are told, needs to be actively saving and planning for that day when he can tell his boss he's not coming back. Retirement is purportedly the time when you can finally do what you want, go where you want, and be the person you have always wanted to be. Retirement has become so normal and expected that there is something wrong with the man who

*Going Till You're Gone - Continued on Page 52*

*Going Till You're Gone - Continued from Page 51*

isn't longing, planning, and saving for it. But where did all of this come from?

During the years I was involved in commercial construction, most of our jobs were government projects. Consequently I spent a good portion of my time working with individuals who were on government payroll. Government jobs have pros and cons. The good part is that your income is predictable and you are rarely affected by recessions. And once you are hired, it is difficult to lose your job. But the downside is that you are surrounded by politics and insider bickering, and if you are too energetic, you can get yourself into trouble. Pointing out ways tasks could be accomplished more efficiently isn't always appreciated.

To survive, many exert no more energy than necessary. They come to work, do the minimum required, and go home as soon as possible. This creates the least concern for upper management and ensures a long career. This same stifling atmosphere pervades many large corporations as well. Day after day, bored workers line up early at the time clock, just waiting to punch out the minute the bell rings.

Obviously, this type of atmosphere isn't very efficient or productive. These workers are capable, healthy, and intelligent. They desperately need an outlet for their energy, and since new ideas that focus on production and efficiency are discouraged, they typically zero in on the weekend's activities, upcoming vacations, and retirement.

Retirement seems to be the favorite of all the topics, and workers discuss the subject endlessly. Many of them know, even down to the number of days, exactly how long it is to retirement. The pros and cons of 401(k)s, IRAs, and different pension plans are hot topics. Stories of others who have retired, where they moved, and what they are doing (or aren't doing) fill the day. It seems the hope of retirement is what gets these employees through each long, boring week. Retirement becomes the carrot dangling out front.

Retirement has become so normal and expected that there is something wrong with the man who isn't longing, planning, and saving for it. But where did all of this come from?

## **This Is It?**

But I have thought about this as I walk past the homes of Spike and Jim. Is this all that bored workers are longing for? To aimlessly putter around the yard or sit in a garage watching TV? Jim has a large home, and the fact that he prefers the garage, even in colder weather, tells a little about how things are going between Mr. Jim and Mrs. Jim. It is said that good marriages get better in retirement and bad ones get worse.

So why does our society long for this kind of existence? Why do many finally arrive at this place only to discover it isn't what they thought it would be?

And where did this idea of retirement come from? Have people always retired? What does God think about retirement? Are there any Scriptural principles that address this topic? Let's begin by looking at the history of retirement.

The topic of retirement is noticeably absent in the Bible. In fact, there is only one place where retirement is directly mentioned, and this is where God speaks to Moses regarding the Levites. *"This is it that belongeth unto the Levites: from twenty and five years old and upward they shall go in to wait upon the service of the tabernacle of the congregation: And from the age of fifty years they shall cease waiting upon the service thereof and shall serve no more."*

The Bible doesn't say why the Lord asked the Levites to stop serving. The next verse insinuates that there was still some work for them to do, but God asked them to stop serving in the tabernacle at

the age of fifty. Maybe we can learn a lesson from God's instructions to the Levites. Although God desires every believer to remain active and productive throughout his life, our abilities change. Our bodies weaken, mental alertness diminishes, and sometimes we are not aware of our reduced capabilities. There may be a time for church leaders to pass on the baton before they really sense the need themselves. I can think of leaders who have successfully passed on their leadership role to younger



## *Retirement as we know it is a very recent innovation.*

ones while remaining active in preaching and in lower-profile avenues of service. This selfless acknowledgment that others have the capacity to lead can bless a congregation. Knowing when this should occur requires prayer, humility, and communication.

Beyond this instruction to the Levites, we find nothing in the Bible encouraging individuals to stop working at a certain age. We find plenty of instruction regarding helping those who are not capable of providing for themselves. But it is safe to say that retirement, as our culture promotes it, is not based on Scripture.

### **Where Did Retirement Come From?**

Retirement as we know it is a very recent innovation. Some older people living today can still remember a time when retirement was almost unknown. During the first half of the 1900s, very few people had enough wealth to just stop working and begin playing. Extra money was scarce, and everyone worked who could. The thought of healthy people just sitting around was preposterous. But in the 1950s, as the postwar economy picked up steam, labor unions bargained with large corporations to increase workers' incomes and benefits. These companies were much more agreeable to concessions that resulted in long-term benefits, such as pension plans that cost them little at the time, than to immediate increases in wages.

Suddenly, for the first time, retirement was a possibility for the common laborer. Now employees of these large corporations could imagine staying home in their older years with a steady flow of income supporting them until they died. Smaller companies soon felt pressured to offer similar plans, and it wasn't long till retirement became a supposed right.

It was a rapid and amazing shift. Just a few years before, in the 1930s, millions of workers had been out of work during the Great Depression, and it had been almost impossible for older Americans to find employment. This had created

major hardships for many older couples. In 1935 President Roosevelt, in response to this need, set up the Old Age, Survivors, and Disability Insurance program, which today we know as Social Security. This program was originally intended as a supplement for those who were disabled or had no means of support in their older years.

But after World War II, politicians, in a bid for public favor, began to rapidly expand Social Security benefits. As the benefits escalated, little thought was given to the future costs of funding this massive program. No one imagined just how large Social Security would become. Elected officials tend to gravitate toward programs that offer instant rewards and delayed consequences. This program offered both.

With the private sector increasingly offering retirement benefits to employees and a government guaranteeing income in old age, the nation's mindset changed rapidly. As financial counselor and author Larry Burkett has said, "By the late sixties, most Americans viewed retirement as a foregone conclusion."

As the years progressed, more and more emphasis was placed on retirement and planning for it. Today financial planners are aghast if you don't have some kind of retirement plan. But for centuries older people worked until they were physically unable, and then family members, churches, or even neighbors in the community assisted the elderly until they passed away.

There is nothing inherently wrong with some planning for retirement. But it is important that we understand the impact our culture has had on us in this area. Our tendency is to ignore Scriptural teaching on caring for the weak and elderly, and our culture can become our reference rather than the Word of God.

*Going Till You're Gone - Continued on Page 54*

Going Till You're Gone - Continued from Page 53

## Conclusion

During my teenage years, one of the ministers in our area made a timeline. It spanned from the creation of the world to the present, and each foot of the timeline represented one hundred years. It took around sixty feet to get from the beginning of time to our day. All along the way he had drawn pictures representing events that happened during each period. At the very beginning was a drawing of Adam and Eve, and about fifteen feet down the timeline was a drawing of Noah's ark. About forty feet from the beginning was the cross, the empty tomb, and the beginning of the church age. Then, almost twenty feet later, he portrayed current events.

That timeline helped put history in perspective. It also revealed how many of the things I viewed as normal were actually recent inventions. Consider for a moment how transportation would look on this timeline. For almost six thousand years, or sixty feet on the timeline, little changed. You either used an animal, a boat, or your legs. Then, in the last hundred years, or only twelve inches on the timeline, man went from those three modes of travel to automobiles, airplanes, and spacecraft. Astounding changes took place in an extremely short period of time!

But we forget this. It often seems that things have always been this way, and we forget how recent and revolutionary some of our everyday conveniences are. Retirement is the same. On that timeline, retirement as we know it would span only about six inches of the entire sixty feet. Yet in the minds of people like Spike and Jim, retirement is a nonnegotiable right and relaxation a goal

worth striving for—in spite of the fact that many retirees spend day after meaningless day vegetating and wistfully longing for some diversion.

But is this what God has in mind? Does He intend for healthy men and women to coast out of life without vision or purpose? The Bible is clear that God has a much higher vision, and we have many examples like Moses, Abraham, and the Apostles who served God until the end. Whatever your age, God has something for you to be involved in. As you continue reading, open your heart to what that might be.

<sup>1</sup> Numbers 8:24-25

**Continued next month....**

*Going Till You're Gone* by Gary Miller is used by permission from TGS International, and is available from TGS International, PO Box 355, Berlin OH 44610. Copyrighted ©2016 by TGS International, a wholly owned subsidiary of Christian Aid Ministries, Berlin OH. Phone 330-893-4828 www.tgsinternational.com.



**Going Till You're Gone**

This book encourages Christians to develop and maintain a Kingdom-focused vision throughout life. It helps readers realize the possibilities of a life sold out for Christ. Most of all, it is a plea for older folks to live a Kingdom-focused life to the end.

6 x 9, Softcover, 281 pages  
EN3046 **\$13.99** Give one to a friend: **2 for \$25**  
25 copies for **\$8.39** ea.



**TO ORDER:** Call 330.893.4828, or order online, or mail or fax your order.

**TGS INTERNATIONAL**  
P.O. Box 355 Berlin, Ohio 44610 USA  
PHONE: 330.893.4828 | FAX: 330.893.2305  
tgsbooks@camoh.org | www.tgsinternational.com

Shipping & Handling for US orders		
Standard Mail Rate*	Priority Mail Rate**	
\$10.01-\$25	\$5.50	\$10.50
\$25.01-\$75	\$7.50	\$12.50
\$75.01-\$249	10% of total	10% of total + \$5

\*\$250+retail orders receive FREE standard shipping within the lower 48 states.  
\*\*Standard shipping/delivery time 6-14 business days.  
\*\*\*Priority mail delivery time 2-3 business days.

All orders must be prepaid. Make checks payable to TGS International. To pay with credit card, please call the number above.  
OH residents add 7% sales tax | PA residents add 6% sales tax

PC20

Low setting emits a yellowish glow, upward, making it perfect for use as a child's night light!

## Need a Millertech<sup>®</sup> Christmas Gift?

- Accomodates Dew and Milw Batteries
- Dual USB Output 2.1 x 2
- (3) Brightness Settings
- 350 Lumens (High)
- Run Times with 5AH Battery: 30 Hrs (High), 300+ Hrs (Low)



### Cordless Tool Battery Night Light, Flash Light, USB Power Supply

Item# 220 (Tool Battery Not Included)

Check your local retailer to purchase these items, or call  
**Millertech at 855-629-5484** Hrs: 7:30 AM - 3:30 PM, Monday-Friday  
**MillerTech Energy Solutions LLC, 17795 Farmington Rd. W. Farmington, OH 44491**



Naturalwood Color

Item# 801W-2 (Whitewash, 2-Bulb = 6.5"W x 5"H x 24.5"L)  
Item# 801W-3 (Whitewash, 3-Bulb = 6.5"W x 5"H x 36.5"L)  
Item# 802B-2 (Naturalwood, 2-Bulb = 6.5"W x 5"H x 24.5"L)  
Item# 802B-3 (Naturalwood, 3-Bulb = 6.5"W x 5"H x 36.5"L)  
Excludes Bulbs/Battery. Specify Battery Brand (Dew/Milw & Makita)



**NEW!**

# Millertech<sup>®</sup> Beam Chandeliers



- Available in 2-Bulb or 3-Bulb
- Choice of Naturalwood or Whitewash Color
- Tool Battery Concealed Inside Beam
- Convenient Pull Chain Switch



Whitewash Color



Item# C950-M  
(Excludes Bulb) Specify color: Whitewash, Black and Battery brand: Dew/Milw & Makita

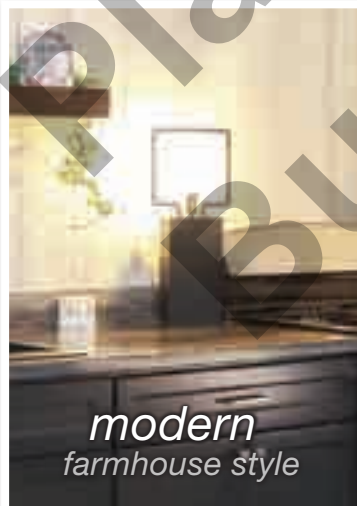

modern  
farmhouse style

**NEW!**

## Cordless LED Modern Tablelamps

- Concealed Battery Compartment
- Simple - Unique Design

Your Trusted Wholesaler Since 2015



Check your local retailer to purchase these items, or call  
Millertech at 855-629-5484 • Hrs: 8AM - 4PM, Monday - Friday

MillerTech Energy Solutions LLC, 17795 Farmington Rd. W. Farmington, OH 44491



# Millertech®

## LED Rechargeable Lanterns

- Accomodates up to a 20W Bulb
- Millertech Battery-powered 12AH (8-Rechargeable D Size Batteries)
- 10.2 Hours Run Time with a 15W Bulb
- Can be recharged up to 2000X
- Moulded plastic body makes it lightweight, yet very durable
- Recharge the battery internally or externally
- Built-in Fuel Gauge
- Low Voltage Alarm • Low Battery Shut-off
- AC or DC Powered Chargers Available



Item# 402  
(Excludes Bulb)  
Please specify  
color when  
ordering!

Now  
Available  
w/ Pull Chain  
ON/OFF!

1  
YEAR  
WARRANTY



Reversible  
Design  
can hang with  
bulb UP or  
DOWN!

↙ You be the Judge! ↘



### Commercial Charger Kits

Charges each Battery/Light  
Individually!

- Built-in Dual USB Outputs
- Built-in Circuit Breaker
- Concealed wiring in 4" x 4" Gutter Box
- Connects directly to Diesel Battery

Item# DC4-8D (4 Bank)  
Item# DC8-8D (8 Bank)

Rechargeable Battery Brand	Amp Hours of Storage	Nominal Voltage	Watt Hours of Storage	Rated Cycles	Average Price	Startup Cost per Watt Hours	Cost per Watt Hour over the life of the battery
Millertech	12	12.8	153.6	2000	ONLY \$75	\$0.49	\$0.00024
Dewalt	9	18.5	166.5	1000	\$129	\$0.77	\$0.00077
Milwaukee	8	18.5	148	1000	\$139	\$0.94	\$0.00094
Makita	6	18.5	111	1000	\$109	\$0.98	\$0.00098

Your Trusted Wholesaler Since 2015

Check your local retailer to purchase these items, or call  
Millertech at 855-629-5484 • Hrs: 8AM - 4PM, Monday - Friday

MillerTech Energy Solutions LLC, 17795 Farmington Rd. W. Farmington, OH 44491



# Need a Last-Minute Christmas Gift?

## Miller<sup>®</sup>tech

### FAMILY OF PORTABLE LED LIGHTING

- Powdercoated Steel
- Many Hanging Options
- Versatile, Ultra-Strong



Item# C910  
(Excludes Battery)

Please specify Battery Brand (Dew/Milw & Makita)

### MillerTech Portable LED Floodlight

- 3900 Lumens - 30W
- Powdercoated steel construction
- Compact design
- Full-flex lighting angle selection
- Multiple hanging options

### MillerTech Economy Light

- Heavy-Duty Steel Construction
- Extra Heavy-Duty Bulb Guard
- Raven Black Powdercoated
- Blinkerboard w/shutoff
- Fits up to a 30 Watt LED Bulb

Item# C905E  
(Excludes Bulb and Battery)

Please specify Battery Brand (Dew/Milw & Makita)



Item# C905  
(Excludes Bulb and Battery)

Please specify Battery Brand (Dew/Milw & Makita)

### MillerTech VERSA Light

- Hangs with Bulb Up or Down
- (2) Wall Mounting Options
- HD Powdercoated Steel Construction
- Extra Heavy-Duty Bulb Guard
- Wrap-around Base Protects Battery
- Attractive Silvervein Color
- Blinkerboard with shutoff
- Fits up to a 30 Watt LED Bulb



Your Trusted Wholesaler Since 2015



Check your local retailer to purchase these items, or call MillerTech at 855-629-5484 • Hrs: 8AM - 4PM, Monday - Friday

MillerTech Energy Solutions LLC, 17795 Farmington Rd. W. Farmington, OH 44491



# Millertech®

NEW!

OUR BRIGHTEST HEADLAMP TO DATE!  
Same great features, 400 more lumens!

5  
YEAR  
WARRANTY



Item# 564  
Retail Price  
\$59.99

THE QUAD

Turbo Mode 2200 Lumens for 30 Seconds

Rechargeable

# LED LIGHTING

Item# 552  
Retail Price  
\$59.99



Model 552 Flashlight &  
Headlamp Supplement Pack

Item# 550  
Retail Price \$19.99



2-Pk 18650 Rechargeable  
2nd Gen Battery  
(3.7V-3500Mah)

NEW!

Millertech LED Rechargeable  
Scooter/Bike Lighting Kit

Item# SB-800 Retail Price = \$59.99

Headlight Features:

- Heavy-Duty Mounting Bracket with Quick Release
- USB-C Rechargeable
- 800 Lumen LED Headlight
- 4000K, Yellowish, Non-Blinding LED Color
- 5 Mode Settings
- Powered by (2) 18650  
2600MAH MillerTech Batteries

Taillight Features:

- USB-C Rechargeable
- 5 Blinking Modes
- Multiple Mounting Options



Double Power 1800 Lumens

Item# 555-2nd  
(2nd Generation)  
Retail Price  
\$55.95

Item# 556-2nd  
(2nd Generation)  
Retail Price  
\$49.99



High Power 750 Lumens

Your Trusted Wholesaler Since 2015

Check your local retailer to purchase these items, or call  
Millertech at 855-629-5484 • Hrs: 8AM - 4PM, Monday - Friday

MillerTech Energy Solutions LLC, 17795 Farmington Rd. W. Farmington, OH 44491



# RECHARGE YOUR

# AIR

# SPACE!

**NEW DESIGN**

Add water without removing the top!

Convenient  
Cordless  
Tool Battery  
Power!

## Millertech®

Clips directly on Tool Battery



Built-in On/Off Switch

### Round Diffusers

Item# 620-B (Brown)  
Item# 620-W (Whitewash)

- Clips Directly on your Favorite Tool Battery Brand (Milw/Dew or Makita)
- 150 ml. Capacity
- Ultrasonic Cool Mist
- Waterless Auto Shut-off
- Power Draw: 9 Watts
- Water Output: 30 ml. - hr.
- Runtime: 10 Hours / 5AH Tool Battery



### Square Diffusers

Item# 630-B (Black), Item# 630-W (White)

- 7 Color LED Light Display
- 200 ml. Capacity
- Ultrasonic Cool Mist
- Waterless Auto Shut-off
- Power Draw: 9 Watts
- Water Output: 60 ml. - hr.
- Runtime: 10 Hours / 5AH Tool Battery



3 Liter Capacity



### Woodgrain Air Humidifiers with Essential Oil Tray

Item# 640-B (Brown)  
Item# 640-W (Whitewash)

- Easily disassemble for cleaning
- Convenient control knob for smooth operation
- Built-in Essential Oil Tray
- Beautiful woodgrain color
- Power Draw: 10 - 20 Watts
- Water Output: 180 ml - hr. max

All our Diffusers and Humidifiers can be powered with our Diffuser Accessory Kit using your favorite Cordless Tool Battery (Dew/Milw - Makita)

Item# 610-KT



Your Trusted Wholesaler Since 2015

Check your local retailer to purchase these items, or call  
Millertech at 855-629-5484 • Hrs: 7:30 AM - 3:30 PM, Monday - Friday  
MillerTech Energy Solutions LLC, 17795 Farmington Rd. W. Farmington, OH 44491

# STAY SAFE

WITH  
**Millertech**<sup>®</sup>



Purchase a Millertech Lithium Battery at any Millertech Authorized Retailer in November/December and send original receipt to Millertech Address below to

**Receive Your FREE Millertech Exclusive Mug!**

*Call Today! Let us help you decide which size battery you need to power your tomorrow!*



Your Trusted Wholesaler Since 2015

Check your local retailer to purchase these items, or call Millertech at 855-629-5484 • Hrs: 7:30 AM - 3:30 PM, Monday - Friday  
MillerTech Energy Solutions LLC, 17795 Farmington Rd. W. Farmington, OH 44491



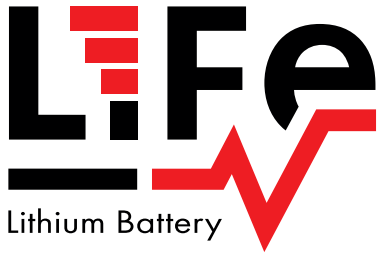

# THE ESSENCE OF YOUR SOLAR POWER SYSTEM!



7 Year Warranty

### It's Everything for Everyone!

Reimagined everywhere that matters, the most versatile and advanced Lithium Battery will fit perfectly into your world. It's forward thinking, with advanced features like a multi-tier communication system capable of monitoring to the cell level, real time state of charge readings, temperature, cycles and current tracking, only the all new LiFe battery can deliver, and you will see it isn't just new, it's evolved for the future!

(Authorized Distributor)



**ZONNA ENERGY**  
330-674-1750 sales@zonnaenergy.com

Call for a Free



Battery Catalog!



Your Trusted Wholesaler Since 2015

Check your local retailer to purchase these items, or call Millertech at 855-629-5484 • Hrs: 7:30AM - 3:30PM, Monday - Friday

MillerTech Energy Solutions LLC, 17795 Farmington Rd. W. Farmington, OH 44491

# Make 2022 A Great Year for Your Business

The start of a new year can be the best time to make changes to your company's culture, attitudes, policies, efficiency, and profitability. We tend to have a sense of optimism as we begin a new year. This opens us up to wanting to make improvements in our life and be more willing to try new opportunities. Our family members and employees often have the same interest, so consider welcoming this opportunity to help everyone in your sphere of influence. As employers, we can use this annual opportunity to implement new strategies and programs that will benefit our employees and the entire business. Here are some of the areas to consider when prioritizing possible actions.

## **Create or Update Essential Employee Documents**

The following documents help our employees understand their position, roles, and tasks in the business, helping improve their satisfaction and sense of accomplishment. The best employees tend to prefer consistent and thorough documentation because they want to be sure everyone is

treated fairly. In situations where a coworker might tend to do mediocre work, good employees know that proper documentation helps protect them from being taken advantage of.

1. Employee Handbook: This document provides the expectations for all employees, regardless of position or compensation method. It establishes the expectations for work schedule, time off, benefits, attendance, appropriate employee behavior, grievances, confidentiality, substance abuse protocols, termination, and other policies. It is legally essential that employee handbooks include policies for non-discrimination, any form of harassment, and employment-at-will. The benefit of the handbook is that it becomes the "sheriff" in the business that everyone signs off on and agrees to work by. With this document, accountability is much easier and good employees feel they are working for a well-run business.



Image Credit: Volodymyr Martyniuk/Shutterstock.com



2. **Job Descriptions:** These documents outline the specific duties, physical requirements, scope of authority, additional periodic duties, and other expectations of a person who fulfills this role. It is specific to a position, but not necessarily an individual. Several individuals can have the same job description. It does not explain how to do the job, but rather focuses on the general and specific tasks that an employee in this position must perform. The most effective job descriptions also include a list of the Key Performance Indicators (KPIs) that an employee in this position has a role in achieving, and some of the Key Results Areas (KRAs) that the employee must understand to do the procedures necessary to achieve the KPIs.
3. **Standard Operating Procedures (SOPs):** These documents list the procedures to do a specific task so the employee has a reference for exactly how to do each procedure. This can be a checklist of how to do each task, a copy of the appropriate sections of the operator's manual for a piece of equipment, device or tool, or something else provided from the manufacturer or the manufacturer's representative.
4. **Performance Evaluation Form:** All employees in a business deserve to be reviewed by their immediate supervisor on a regular basis. To ensure fairness to all employees, there should be a standard form that includes a list of the areas that each person will be evaluated on. The form can include a list of key areas of performance such as teamwork, attention to detail, timeliness, dependability, quality, attitude, taking initiative, integrity, attendance, communication, teachability, problem solving, neatness, safety, time management, work level/endurance, and emotional maturity. Some of the categories will have specific data you can refer to that shows the employee how well they are doing in each area, while other areas are more subjective and require the reviewer to provide evidence of their observations. The main objective is to help the employee improve their overall performance and provide encouragement and praise for the good work they have done. It also gives them an opportunity to provide feedback on how they feel they are doing and areas where they would like to have additional opportunities for self-improvement and learning new skills.

5. **Job Application Form:** This is a standard form to be completed by all applicants to make certain the selection process is fair to each candidate, and to confirm important background information such as contact information, education, experience, references, certifications, and specific qualifications for the job. A job application form streamlines the selection process and helps you be sure you have collected all the information you need from each candidate.

#### **Review Staff Efficiency and Effectiveness**

Analyze how labor was utilized the last few years and consider ways to reduce the hours allocated to each enterprise and activity. In family operations, enhancing your efficiency and effectiveness means you will have more time available for family activities, you'll be under less stress, and greater attention can be devoted to areas of the business that can benefit from additional management.

If you've made investments in equipment, tools or other improvements that were supposed to save time and make you more efficient, analyze whether or not those benefits were realized. Analyze the labor needs of each enterprise and look for opportunities to trim labor costs and improve productivity.

#### **Review Your Long-Range Labor Strategy**

The successful, forward-thinking businessperson has an overall strategic plan for their business that includes vision and mission statements, specific goals, and timetables for accomplishing those goals. A shrinking labor pool, greater competition, and rising benefit costs demand that we also have a strategic plan for our long-term labor needs. This plan should address the following questions:

- Who will our labor force be in the next few years?
- How will we attract them?
- Who is our main competition for labor?
- How will we keep the good employees that we develop?
- How will we reduce our labor costs while continuing to pay competitive wages and benefits?

These questions provide a basic introduction to the issues that must be addressed to develop your strategy. It is essential for this discussion to be open-minded to ensure all ideas are welcomed, creative solutions are discussed, and that action steps are implemented.

*A Great Year for Your Business - Continued on Page 64*

### **Enhance Your Culture**

Your company culture refers to the shared values, attitudes, standards, and beliefs that characterize your organization and define its nature. It is rooted in the organization's vision, goals, strategies, and structure. It is hard to contain every facet of a company's culture in a document because much of it is realized in the social atmosphere of the day-to-day interactions between coworkers, leaders, and others they work with every day.

Developing, reinforcing, and enhancing company culture is growing more difficult. The variety of worldviews, work ethics, generational differences, and personal interests in any given workforce can be quite broad, making it difficult to please everyone.

A well-established culture provides many benefits, including a clear understanding of appropriate and inappropriate behavior, a vision that is fully comprehended by everyone, simplified decision-making, and employees that are engaged and empowered.

Begin by defining the core values that you, your family and your employees feel are best for your business. Talk to each person one-on-one to get their input on their preferred culture. Ask what they feel is currently positive in the culture, and what they would like to see improved.

In family operations, a good place to start is a discussion about personal preferences on work-life balance. These can vary significantly from one generation to the next, and between different families. Tension develops when we do not have clear expectations based on what is considered fair for everyone. From there, talk about your core values, your desired image in the community and industry, and how you will express these in all your interactions within and outside of the business.

### **Update Your Business Plan**

If you already have a written business plan, the beginning of the year is a great time to give it a full review. If you haven't developed one, I encourage you to consider it. Unfortunately, many small-business owners don't believe they need a business plan. They think it sounds too formal and that it will be too much work for no more than they feel they will use it.

A professionally written and formatted business plan helps attract the best potential lenders, vendors, and business partners by showing that your business is organized, has

an established strategic plan, a vision for its future and a written track record of its progress. A regularly updated plan helps educate the next generation about the family's history and successful business philosophies, as well as streamline the process of transitioning the business from one generation to the next.

The process of developing a written business plan has its own inherent value. Developing each area of content, discussing what should be included, compiling the information, and creating your company's story can provide your family and key businesspeople with an opportunity to share their thoughts and be a part of a significant project for your business's future. *\*Editor's note: See the article authored by Don Tyler in December 2020 PCBE for a more detailed review of developing a Business Plan.*

### **Evaluate Your Business**

Evaluating your business does not need to be a long and detailed process. The quality of your analysis will provide more specific results, but sometimes we simply need to ask ourselves a few key questions to make sure we understand how our business is doing. We must first start with a checklist of some basic business practices. Here are some items to consider in your checklist:

1. Cost of Production: Do you know your cost of production for each item you make or service you provide? Far too many business owners calculate their rates and charges using the cost of materials multiplied by a standard number, or their actual wage rate multiplied by a set percentage, without knowing their actual cost to provide the product or service. This method is simply guessing the costs for buying and storing inventory, shrinkage, overhead, etc. For us to maximize our profitability and ensure that we are charging a sufficient amount for everything we provide, we need to know the exact costs of each area. We may be over-charging in some areas causing us to be outbid by our competition, or under-charging in other areas, not covering our costs. Perhaps the multiples are working for you now, but knowing the exact cost will help you adjust prices when costs go up or down and ensure that your fees are competitive.
2. Cash Flow: Do you have a monthly cash flow that details your revenue and expenses in each category? This information lets you see the seasonal ups and downs of your business as well as the impact of certain expenses through the year. Some months may have



more payments due than others. There may be certain times of the year that your accounts receivable are much higher than others. Knowing this information gives you clarity on when the money is coming in and going out so you can ensure you have the cash on hand to make payments when they are due.

3. **Monthly Budget:** Using the same categories that are listed in your monthly cash flow, you can create a monthly budget. The cash flow report reveals what has already happened. The budget looks to the future and uses the historical revenues and expenses from your cash flow and projects them month by month for a year or longer into the future. A budget is a powerful tool to use when trying to decide if you can afford a new piece of equipment, schedule major repairs, predict cash flow needs to meet interest and principal payments, anticipate when receivables will be delayed, or the impact of adding a new service to your business. The budget is established at the beginning of the year for the next 12 months, and then updated each month as the year progresses. You can also add the next month to the next year's budget as each month of this

year is closed out, so that you are always looking at least 12 months into the future. As each current month is closed out, you compare the actual income and expenses to your estimated amounts for each area to see if you are on track.

As you consider which of these specific areas would provide the best value for you, your family, and your business, consider writing a few goals for next year. Last month's article on Setting and Achieving Goals provides insights into that process. Don't try to do take on too much. Focus on what will be the most practical topic that will give you the most immediate benefit, then work on the next one with the most value.

Make 2022 your Best Year Ever!

*Don Tyler is Founder of Tyler & Associates Executive and Management Coaching. Don grew up on a family farm, has managed businesses for 16 years and has been a private coach for the last 26 years with clients across the country in all types of businesses. For more information about this topic or other areas of employee management, business development, family business succession and management, or to be a speaker for your business or organization, he can be reached at 765-490-0353, through e-mail at don@dontyler.com, or his website at www.dontyler.com*

## Gifts for Cheese Loving Family Members

*Give quality straight from the farm!*

- We ship direct for you.
- Try out signature cheese: Goot Essa's 3 year old sharp cheddar
- Try our assortments featuring beef sticks & sliced ham
- The Goot Essa Cheese Subscription - perfect for that key employee / or cheese loving husband/wife
- Please call for details - John: 814-383-0180 or Steven: 814-482-1353

Call for 20 page catalog that highlights our 19 cheeses

3 YEAR OLD SHARP CHEDDAR



HOLIDAY PICNIC BASKET



GOURMET COLLECTION



351 Wise Road, Howard, Pennsylvania 16841 | **800-490-4387**  
 Web: [www.gootessacheese.com](http://www.gootessacheese.com) | Email: [gootessacheese@gmail.com](mailto:gootessacheese@gmail.com)

*Connecting with people is just good business!*



Laser Cutting



Custom Fabrication

**DS Fabrication, a division of DS Machine LLC.**

A collaborative partner in the community for generations, helping business grow by providing short or long run production, as well as prototypes. Production fabrication for large, high-volume runs as well as custom fabrication. There is no job too small and hardly any too big. The DS craftsmen, technicians and engineers take great pride in the work we produce to help grow our client's business.



Metal Forming



Welding

**Gordonville, PA | 717-768-3853** *(Please call for your closest dealer.)*



# Get the Gift of Health This Year with Nutrition Wellness Center



## Are YOU Suffering from...?

Achy Joints	Brain Fog	Fibroids/Cysts	Insomnia	Rashes	Asthma
Acne	Constipation	Hair Loss	Lyme Disease	Ringing Ears	Coughing
Anxiety	Depression	Headaches	Memory Loss	Sleep Issues	Infertility
Arthritis	Digestive Issues	Hemorrhoids	Migraines	Thyroid Issues	Pain
Bed Wetting	Erectile Dysfunction	High Blood Pressure	Mood Swings	Warts	Weight Loss
Behavioral Problems	Fatigue/Low Energy	Hormone Imbalance	Nausea	Weight Gain	

—> **YOU ARE WORTH IT!** Your health is worth it! Make the investment in yourself this season! We have been helping people **just like you** find relief from their suffering for OVER 46 years! **Trust the experts and let us help YOU!**

**This Christmas Season, we are Offering an Amazing Bundle Packet for anyone who is ready to find RELIEF from their symptoms!**

**Just CALL us for your Christmas Bundle: 1-800-222-3610**

### AMAZING Christmas Bundle!

- \$100 OFF Testing When You Mention Christmas Bundle!
- One-on-One Health Coaching Consultation
- A Free Wordsearch Puzzle Book
- A Free Copy of Our "Health Epidemic Report"
- A FREE Information and Starter Packet
- AND A BONUS GIFT!

**MUST BE REQUESTED BY:**

**December 30th, 2021**

**★ Yes! Valued at  
over \$225 ALL  
Completely FREE!**

Don't have easy access to a phone?

**Don't miss out on this AMAZING CHRISTMAS DEAL!**

Simply fill out and mail in this form:

Name: \_\_\_\_\_

Date of Birth: \_\_\_\_\_

Phone Number: \_\_\_\_\_

Address: \_\_\_\_\_

City: \_\_\_\_\_

State: \_\_\_\_\_ Zip code: \_\_\_\_\_

**Mail to:** Nutrition Wellness Center 3665 Bee Ridge Road,  
Suite 200 Sarasota, FL 34233

**Only send this form in if you are serious about getting help!**

Disclaimer: For educational purposes only. We do not claim to treat, cure, diagnose, or prevent disease. This information has not been evaluated by the Food and Drug Administration.



## Kozy Kote

After eyeing this new hunting coat up for a while, All I could think of was the times out in in the tree stand, the first half hour you're cozy, almost sweating from the walk to the woods. The next 3 hours you're trying hard to stay warm, toes are cold, fingers are almost numb, and then of course you start shaking so much the tree stand starts rattling. Well of course that's exaggerating a little, but you get the point, it's not fun hunting when you can't feel your toes. So, with that being said, after I received this Kozy Kote, I was really excited for the next really cold morning to go try it out. One thing that I thought was neat, it has holes on the bottom for your feet to stick out, that way you can put it on, standing on the ground and safely climb into your tree stand and then when you're in your tree stand, there are small boots that go over your feet. Another thing I thought was great, there are 2 holes to stick your hands out to shoot. I figured it might get in the way at times, however I was wrong. I was surprised how free my hands were. All in all, I'm certain you will stay warm if you try one of these. By the way, this will also make an awesome Christmas gift!!

—PCBE Team Member



**Benton Bow Shop @ 330-464-7808**

For more information, refer to the advertisement on page 156.

## Cordless Vacuum Sealer

Recently we purchased a freeze dryer and soon learned that we should have a heat sealer to seal the bags of dried food. Although we do not need to vacuum the bags, it is helpful to remove as much oxygen as possible and this sealer does a great job at doing just that. It has a very quick seal and is easy to operate. The cordless option is also a very nice feature as you can move it around or take it on the go.

I am excited to try this on other foods for the freezer, etc! —PCBE Team Member



**Eagle Food Equipment @ 833-693-4144**



Find out how you can get your new tool or product featured in this column by contacting PCBE at 717-362-1118 ext 115

### **Barrel Lamp**

Are you looking for a last-minute Christmas gift for your wife or special friend, this light features a 10-watt dimmable bulb, shade, and battery adapter (Milwaukee, DeWalt, Makita), but is also available in AC. all this is mounted on a nice rustic looking barrel (battery on the inside) making it a nice center piece on any table.

**Wicky's Handy Dandy LLC 260-452-8754**



For more information, refer to the advertisement on page 104.

### **CollagenB3**

CollagenB3 is a unique, synergistic blend of Collagen Protein, MCT Oil, Hyaluronic Acid, Chaga, with a Mineral Complex, plus Amino Acids, Cordyceps, Magnesium, and Ginseng to help you look, think, and feel amazing.\* This comprehensive collagen product is perfect for those looking to support healthy hair, skin, nails, musculoskeletal function, and to provide brain fuel for energy and focus.

Collagen is the body's most abundant, fibrous protein that helps give structure and strength to hair, skin, nails, bones, ligaments, and tendons. Collagen is derived from the Greek word for glue as it holds everything in the body together. Because of collagen, we're able to move and flex.

*I sprained my wrist and after multiple re-occurring injuries and living with occasional pain for 1.5 years, all the pain cleared after taking Collagen B3 for about 2 weeks. Jerry Fisher – Allenwood PA*



**Jerry and Kathryn Fisher @ 570-217-3618**

# 2024

# A NEW YEAR, A BETTER BRAND!

There's an old saying that goes something like this: you can't expect different results if you keep doing things the same way. Whether you have a new business that needs to promote a positive first impression or have an existing business that needs a refresh, we can help you achieve improved results through strategic branding and marketing materials.

We have been helping plain community businesses grow for more than 12 years. You have likely seen our work – we work with many businesses in this publication, including PCBE itself. If you see a nicely branded business with a professionally designed ad that makes you take notice and say things like "Oooh! I need that" and "Ahhh, that looks impressive!", it is likely our work.

We work with all sizes of businesses and give equal care and attention to each of our clients. We can communicate and review projects by phone, fax, mail, email, and in-person if needed. We are experienced in all areas of branding and visual marketing, and can help walk you through the process of creating an effective and memorable brand, from naming a business to logo design to ad design and placement to digital marketing opportunities (even if you do not have internet access). If you have existing marketing materials and strategies in place, we can provide a thorough brand audit, identifying areas that could be improved and defining solutions for how to achieve the desired goals.

**We are committed to providing exceptional customer service and effective marketing solutions. But don't take our word for it, here's what some of our clients have said:**

When we met Back Forty Creative at the MOSES Organic Conference in 2015, I asked them if they could do some design work for us. I did not have any idea of the level of service that would come with it, as we were looking for some packaging designs as well as website assistance. We feel we hired a highly professional marketing team as they always do a great job with designing and scheduling ads, creating trade show booth graphics, and designing brochures on short notice. They also did a great job developing our NEMO website, along with developing two other websites for additional businesses. They have exceeded our expectations – Back Forty Creative will always go to bat for their customers.

**Alvin B.**  
NEMO FEED

Back Forty Creative is a very professional design company with highly experienced designers. We have been working together for only four months, but I can say they have exceeded our expectations. Initially, their promptness and creativity caught our attention and we haven't been disappointed. Since we started the rebranding project, a lot of ground has been covered, including refinements to our logo, product labels, website, ads, and promotional items. With hundreds of product labels and details galore, they have stood up to the test well. They are well-organized and easy to work with.

**Ben S.**  
NATURAL HOPE HERBALS





# DON'T SUFFER ANOTHER YEAR WITH A BAD BRAND!

## First Impressions are Lasting



If your marketing materials, such as your logo, packaging, brochures, direct mail pieces, publication advertisements, or social media marketing, don't immediately communicate the same strategic message and use cohesive designs and visuals, then your business may be suffering from a branding crisis.

Whether you need a full brand overhaul, or simply refinements to your existing logo, print materials, website, or marketing strategy, Back Forty Creative can help!

**Call us today! 314.690.4793**

### Top five benefits of having exceptional branding

- 1 Eye-catching marketing materials lead consumers to select your product or service over others
- 2 Memorable branding builds brand recognition and repeat business
- 3 Relatively low upfront investments lead to ongoing and sustainable profits
- 4 Great visual branding helps validate your brand or business
- 5 Strategic messaging effectively tells your customer how to respond with a call-to-action

Back Forty Creative has done a very professional job with getting the feel of what our customers want and making it look very attractive and eye-catching to the end-users.

**Gilbert H.**  
A-2 IMMUNE



**314.690.4793 • backfortycreative.com**

Locations in New York & Missouri to serve good people everywhere.



QUALITY PRODUCTS AT A FAIR PRICE, FOR THE PEOPLE WHO KNOW THE DIFFERENCE

# MICHIANA Equipment

**WE DESIGN, BUILD AND EQUIP COMPLETE HOUSING**



DEALERS OF

**Big Dutchman.**

INNOVATIVE SYSTEMS FOR MODERN EGG, POULTRY AND PIG PRODUCTION



ASK FOR OUR  
NEW 100 PAGE  
CATALOG!

Call **574.642.4768** for a free consultation!

or come visit MICHIANA at: 12865-2 CR 30, Middlebury, IN 46540 Fax (844) 840-2470



## Email to Fax

Send and receive emails without a computer. Using only your fax machine

- Fast Delivery, message come thru in under 10 minutes.
- First 25 pages ea month are free, 30.10 thereafter
- attachments supported: DOC, TXT, RTF, PDF, HTML, XLS, JPG, and OpenOffice formats.
- We support a large range of attachments that are automatically converted: DOC, TXT, RTF, PDF, HTML, XLS, JPG, and OpenOffice formats.

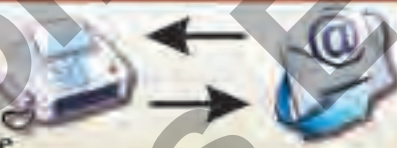

## Internet by Fax

Internet by fax is a manual service that we offer. You write down what you are looking for and fax it to us. We attempt to find it, and fax it back to you.

Sample of requests we handle:

- Get me a parts list for \_\_\_\_\_
- Get me a fax form number \_\_\_\_\_
- Order these part numbers from my supplier, \_\_\_\_\_
- Find \_\_\_\_\_ on eBay for me.
- Check TractorHouse.com for \_\_\_\_\_ model.
- Find pictures of some items that are listed on an auction \_\_\_\_\_
- Book Airline or Train tickets.
- Print shipping labels, We can provide USPS, Fedex, and UPS labels, Using your account, or ours.

If you can describe what you are looking for, we can find it.

I am very well please with your service. The service my customers being able to email purchase orders. And I can receive them my fax machine is very beneficial for both of us. And I let mine log file that your fax. Most of the time I will receive my orders 2 minutes after they email it. Thanks for your prompt service.

Creative Woodworks, Sugar Creek, OH

We are satisfied with the service we get. It is a good cost to communicate with our customers with the mail/fax. We want to thank Mtech to provide this service. Our customers like to communicate like do we. Thanks to IbyFax.

Ephraim Yoder - Valley View Pallets, Greenville, OH

Thank you for your fast, accurate and friendly service. We use the email service as well as the Internet by Fax service. Both work well for us. I think this is a great service to use in place between them. Thank you.

Elvis Martin - Cedar Creek Tools, Ontario, Canada

A lot of our work is for a retail cabinet company. IbyFax allows us to send a message to their email or email phone accordingly our fax machine than downloading our work for computers or cellphones. It also gives my many trips to the place that.

John - County Line Cabinetry, Middlebury, OH

IbyFax has been helpful to me already in making it possible to correspond with customers that do not have fax. I use it to send drawings of cabinets via to have the customer okay them before they go into production. It also works good to get appliances spot orders from vendors.

Lavern - L & C Custom Woodworks, Elletts MD

IbyFax is a great service! My hundreds of pages of LPH (Lift & Lay) in the last 30 days saved time from my dealers. Also IbyFax is a great way to correspond with my customers via email to fax.

Josiah Yoder - Yoder Cedar Works, St. Marys, OH

Call us today  
315-828-7799

Mtech

1575 State Rte 5 and 20  
Gambria NE 48456  
Phone: 315-828-7799  
Fax: 585-283-0978

IbyFax



# DISCOVER AMERICA TOURS LLC

4929 Parks West Rd  
Middlefield, Ohio 44062  
**440-321-1534**

Let Discover America Tours take you on a vacation you deserve... stress free!!

FULL 2022 TOUR SCHEDULE NOW AVAILABLE!

## 2022 SCHEDULE

### WEEK & MULTI WEEK TOURS

June 1-18 ..... Western Adventure Tour  
July 25-30 ..... Smokey Mountain Tour  
October 10-15 ..... Vermont Fall Tour

### MULTI DAY TOURS

June 23-25 ..... The Shack, Michigan Tour  
August 5 & 6 ..... Hershey PA & Flight 93 Tour  
Sept. 8-10 ..... Horse Lover's Paradise Tour

Call to make your reservations today, before there sold out!!

**VACATION PLANNING, GROUP & PRIVATE TOUR SERVICE**

# DUTCH COUNTRY GRAINS

*Taste the goodness of whole grain.*

Grind your own Grains,  
Hand Crank GrainMaker Mills  
GrainMaker Roller/Flaker  
GrainMaker Motor Setup  
NutriMills



Wheat and Whole Grains,

Prairie Gold  
Bronze Chief  
Hard Red Winter  
Spelt  
Soft White  
Oat Groats  
Einkorn  
Organic Kamut

Dutch Country Grains  
Joel and Tina Kurts  
Phone: (330) 359-2070  
Email: sales@healthyheritage.com

Located at:  
Pleasant Hill Bulk Food and Variety, 8584 TR 556, Fredericksburg OH 44627

**NEW STYLE. VERY HIGH QUALITY. BEST EVER. STEEL HOUSING. BETTER SEALING. LONGER LIFE.**



**TIMKEN**  
TIMKEN® SELF-ALIGNING  
TAPERED ROLLER BEARING  
HOUSED UNITS

Timken® Self-Aligning Tapered Roller Bearing Housed Units are designed for applications from aggregate and steel to mining and power generation. The heavy duty housing and cartridge are made from cast steel to stand up to the harshest conditions, and are designed to accept +/- degrees of misalignment.

The tapered roller bearing yields a design life that is 47% higher than current industry leading competitor. Timken® high-performance seals are seven times more effective against water ingress.

Available in two-bolt pillow block sizes 1 1/4 - 3 1/2 in. (35-90 mm), and in four bolt pillow block 2 1/4 - 5 in. (60-125 mm).

*We also sell other brands of power transmission products.*



SHIPPING AND DELIVERY AVAILABLE

WRITE OR CALL FOR SPECIAL PRICING  
167 KENTUCKY AVENUE, PUNXSUTAWNEY, PA 15767  
PHONE: 814-427-4222



CARLISLE, PA 717-960-9600

Authorized Distributor for Tigerlights & Federal Power Products.  
Serving the Northeast. Dealer inquiries welcome!!

## 2021 December Sale

10% Discount on all Tiger Lights and 5% Discount on Engine Parts  
Sale runs from December 1<sup>st</sup> thru December 31<sup>st</sup>

Federal Power Products

Plug&Play Led Tigerlights



RELIANCE Kits also available



Limited Lifetime Warranty!

Reman Longblock Engines for:

JD, Case, Cummins, International, Ford, and other makes.



\$500.00 Free Freight on Most Items (Excluding Truck Freight)

John Deere 20 Series Power Steering Kit  
2510 thru 4320 Models  
**\$1,150.00**



Sales@Evergreenagparts.com  
www.Evergreenagparts.com



Candace Brown

*Record-Breaking Relics of*  
**NORTHWEST LOGGING HISTORY**  
**SURVIVE AT DIZZYING HEIGHTS**





In the extreme northwest corner of the contiguous United States, Washington's Olympic Peninsula holds about 3,600 square miles of mountainous natural beauty. It is also home to two amazing examples of early 20th century engineering, one being the highest arched railroad bridge ever built in the United States. The 685-foot-long High Steel Bridge, in Mason County, spans the glacier-fed Skokomish River's South Fork that rushes below it between the nearly vertical walls of a 400-foot-deep gorge. In 1928, the Simpson Logging Company hired the American Bridge Company of Pennsylvania to build two single-track, steel, truss arch railroad bridges so logging trains could reach previously inaccessible timberlands. The High Steel Bridge (also called the South Fork Skokomish Bridge) was actually the second one built. It followed the 347-foot-high Vance Creek Bridge, three miles away, which is slightly longer but also slightly lower. Both were completed during 1929, and neither has carried trains in decades.

The history of logging on the Olympic Peninsula and the state's southern coast began long before these impressive structures existed. A massive temperate rainforest in the Pacific Northwest once extended from southwest Alaska to the southern coast of Oregon, soaked by 150 or more inches of rain annually. In the 19th century, the Olympic Peninsula became famous for its forests of ancient

*Record Breaking Relics of Northwest Logging*  
- Continued on Page 76

Not just another high bridge made of steel, the "High Steel Bridge" near Shelton, Washington, was given that phrase as its official name. When built in 1929, by the American Bridge Company, for the Simpson Logging Company, it was the highest railroad bridge in the nation, and one of the top 12 highest bridges in the world. It carried a single track for trains hauling huge logs across the south fork of the Skokomish River, approximately 400 feet below, in country so rugged one can hardly imagine how the construction was possible, especially at that time.

Image by: ken18/Shutterstock.com





Workers from the American Bridge Co. used a large crane to lower sections of the High Steel Bridge into place during construction.

Image Credit: Mason County Historical Society Museum



This view of the High Steel Bridge's construction shows how the arch is anchored into the vertical cliff wall.

Image Credit: Mason County Historical Society Museum

*Record Breaking Relics of Northwest Logging - Continued from Page 75*

virgin timber, a seemingly inexhaustible supply that was soon in demand even beyond U.S. borders. Harvesting of this rich resource began in the 1850s, starting with trees easily accessed along the shores of Puget Sound. The forests were deep, dark, and damp, filled with towering conifers, including cedar, but mostly the coastal Douglas fir measuring up to 40 feet in circumference, or approximately 13 feet in diameter. Some were 500-1000 years old and more than 200 feet tall. The spreading branches allowed little sunlight to penetrate to the ground. An excerpt from the book *Logging to the Salt Chuck* by the late John T. Labbe and Peter J. Replinger offers a perfect description: "The floor of the forest was damp and mushy, covered largely with moss and ferns growing on the rotting remnants of fallen giants from earlier times."

Replinger has lived in Mason County, in the town of Shelton, all his life and has loved everything to do with railroads since the age of three. Beginning in 1963, he worked for Simpson Timber Company for 39 years, mostly as a railroad engineer. He is a respected historian with a youthful enthusiasm for trains. As a young teenager he used a box camera to take pictures of the last of the steam locomotives and, over his life, has documented a vast amount of history through photography, built a huge collection of historic photos, and



owned two vintage locomotives. He remembers hearing the stories the old timers told, like this one about the High Steel Bridge, from the 1930s: “One time, a train came over the bridge, and they derailed the locomotive just on the other side,” he said. “The whole train of logs was stretched across the bridge, and the loggers had no way to get back to camp except to crawl over the thing.”

In the early days, long two-man crosscut saws, commonly called “misery whips,” could bring down a huge tree after a pair of loggers spent several hours drawing it back and forth between them. They each stood on a springboard stuck into opposite sides of the trunk high enough to let them make the cut above the thickest part of the base, where it flared outward into the roots. As many as a dozen oxen (called “bulls”) would be used to pull huge logs, or sections of logs, out of the woods along a “skid road” to the water to be bound together in rafts and floated to a sawmill. A man named Solomon G. “Sol” Simpson, whose future logging company would become famous, ignored tradition and used horses instead, an innovation that worked well for him because of his expert knowledge and experience with them.

Simpson was born in Quebec in 1843 and worked as a timber raftsman on the Ottawa and Saint Lawrence rivers. In 1865, he left behind the life he had known for that of a fortune seeker, moving to Carson City, Nevada, where he hoped to

make money in the gold and silver mines. When that plan failed, he took up logging and road grading and married a local woman. Over the next eight years, Simpson became highly skillful at his trades. The couple had their first child, a young daughter, when they moved to Seattle, Washington, in 1878. He graded roads there and also used his horses to haul logs for the Seattle & Eastern Railroad and the Port Blakely Mill Company, incorporated in 1876 on Bainbridge Island, directly west of Seattle across Puget Sound.

Simpson’s practice of using horses instead of oxen was considered shocking and unacceptable by some, but the horses moved faster and ate less. However, animal power would soon be a thing of the past after the steam donkey and the logging railroad appeared. The “donkey,” developed in 1882 by a Californian named John Dolbeer, consisted of one or more steam-powered winches mounted on skids. The logging crew attached to the logs—some previously too large to move—long cables coming from the winch then “yarded” them through the forest along “skid roads” to where they could be processed for shipment. The donkey saved money, reduced labor, worked in the most difficult terrain or soggy locations, and needed neither food nor shelter. By 1890, it had effectively replaced the beasts of burden and, along with railroads, revolutionized logging.

In 1882, the Port Blakely mill’s average daily production of  
*Record Breaking Relics of Northwest Logging - Continued on Page 78*



This photo by Darius Kinsey in Washington is representative of the industry and the size of logs carried on trains.

Image Credit: J. Paul Getty Museum Los Angeles, CA Digital image courtesy of the Getty's Open Content Program.



When photographer Darius Kinsey (1869-1945) photographed this scene representative of the era, he titled it “Logging Train and Donkeys in the Wonderful Woods of Washington, 1908” .

Image Credit: J. Paul Getty Museum Los Angeles, CA Digital image courtesy of the Getty's Open Content Program.



This Olympic National Forest Historic Photo, from the collections of the U.S. Forest Service, is titled 32575 *Logging with Ox Teams, Hoquiam, WA 1902.* Public Domain



Photographer Clark Kinsey (1877–1956) photographed Simpson Logging Company crew members posed with this locomotive in about 1924. "It was #9, a Baldwin 2-8-2 built in 1910 and was the last Simpson steam locomotive scrapped in 1958," Replinger said. Public Domain

*Record Breaking Relics of Northwest Logging - Continued from Page 77*

lumber reached 200,000 board feet, surpassing all other sawmills on the West Coast and possibly in the world. The business needed all the logs it could get. The company foreclosed on the Puget Sound & Grays Harbor Railroad it had constructed and reorganized as the Blakely Railroad with the goal of penetrating the dense expanses of virgin timber in Mason County and beyond. Logs hauled to the small community of Kamilche on the shores of Skookum Inlet in the southern reaches of Puget Sound would be floated north to the mill.

Building a railroad required removing trees along the route and then grading the rail bed. Simpson, with all his logging and grading experience, was the man for the job. He arrived with his crew in 1885, and by 1887 had moved his family to Mason County, where he laid ties and rails for the Port Blakely Mill Company's new extension that ran northwest from Kamilche to Matlock. He founded his

own S.G. Simpson Company in 1890 and, in 1895, partnered with Alfred Anderson to incorporate the Simpson Logging Company. It became successful almost at once, bolstered by sales to the Port Blakely business. Anderson simultaneously established the Peninsular Railway Company to handle railroad operations for Simpson Logging, which was logging timberlands belonging to the estate of Anderson's father-in-law as well as those owned by the Port Blakely Mill Company. As a common carrier, the Peninsular Railway also served other logging camps.

The Panic of 1893 doomed many commercial loggers, but Sol Simpson survived and prospered. He had a mind for innovation. The maximum distance the donkeys could pull logs was about a mile, but he pictured steam locomotives running on tracks laid down on the skid roads. In 1896, he placed the first order ever on the West Coast for a pair of Heisler locomotives. By October of that year, 3,800,000 feet of logs harvested by Simpson's crews floated on Puget Sound in Port Blakely Mill Company's log booms.





This Darius Kinsey photo, taken in Washington in 1915, illustrates the massive size of the felled trees in proportion to the logger with his crosscut saw.

Image Credit: J. Paul Getty Museum Los Angeles, CA Digital image courtesy of the Getty's Open Content Program.

One of the companies that fell victim to the Panic of 1893 belonged to a man named Mark Reed who was 31 years old when he met Sol Simpson in 1897. Simpson hired him as a logging camp foreman, but Reed also became his son-in-law. The Simpson Logging Company's multiple camps prospered by 1898, transporting logs by train on the 80 miles of track, running from Shelton to Lake Nahwatzel just east of Mallock, that served both the Simpson Logging Company Railroad and the Peninsular Railway Company continuously for well more than a century. Together, they owned at total of 13 locomotives at one point, and the trains might each have about 40 railcars full of logs. It would end up being the last operational privately owned logging railroad in the continental United States.

The Port Blakely Mill Company had acquired 80,000 acres of timberland by 1891, but the decade of the 1890s brought intense competition from outside the area, first from the St. Paul & Tacoma Lumber Company and then Weyerhaeuser, which appeared on the scene in 1900 and acquired 900,000 acres of forest. Simpson wanted more independence as a commercial logger, especially when accepting bids, so ended his business relationship with the Port Blakely Mill Company in 1902. By 1905, the State of Washington dominated lumber production in the U.S. with Simpson's prominence well established. After Sol Simpson died in 1906, Mark Reed stepped into his shoes, although

he did not officially become president until 1914. He brought progressive ideas, including diversification. His leadership led to the establishment of the Reed Sawmill in Shelton in 1925 and, a few years later, the two new steel bridges on the rail system that would extend the company's reach into untouched timberland.

Completion of the Vance Creek Bridge allowed materials to be transported over it to build the High Creek Bridge. According to inventory documents from the HAER — the Historic American Engineering Record, Department of the Interior—those materials included, "... a considerable amount of concrete for the footings, lumber for the decking, concrete forms, and railing, and 750 tons of steel..." On September 19, 1929, the *Shelton-Mason County Journal* newspaper published an article titled *State's High Span Bridge Complete*. It stated that the bridge "...proved perfect in fabrication at the Eastern shops and was erected without a serious accident, the massive cranes, donkey and strong cables handling the heavy structural pieces with ease and the skill of the special workmen putting them in place and setting over 40,000 hot rivets high in the air with safety."

An article in the Tacoma Daily Ledger on September 22, 1929 reported that "The new structure was erected within a period of three months by expert workmen, following receipt from the east of necessary units of fabricated steel." Beyond the contracted price of \$131,000, it cost an additional \$100,000 for lumber. The article also stated that, "Both of the new bridges are on the new branch line of the Peninsular Railroad, extending into the untouched timber region between the forks of the Skokomish River and planned to reach back beyond Lake Cushman when present timber is exhausted."

"It was a dead end branch line," Replinger said. "They had spur lines going off of it, but the branch line never went any farther than Lake Cushman. The Camp 3 logging camp was about a half a mile this side of the High Steel Bridge." The camp would have housed about 200 men. Logs from Camp 3 were rafted down to Shelton and dumped in the water to feed the two sawmills there.

The depths of the gulches below the bridges made the use of falsework impossible. Instead, cableways and tiebacks installed in the rock cliffs anchored the bridge while

*Record Breaking Relics of Northwest Logging - Continued on Page 80*

*Record Breaking Relics of Northwest Logging - Continued from Page 79*

cantilevering the arches. Workers did employ a locomotive crane for part of the process, but the risk of having the crane put too much strain on the tiebacks made it necessary to use the cableways and tieback system to position the rest of the cantilever. The bridges were constructed in two halves, the gap being closed after all parts had been adjusted.



Image by Greg Rakoczy/Unsplash

## OFFERING A GREAT EXPERIENCE

Mason County Historical Society Museum  
P.O. Box 1366  
427 West Railroad Avenue  
Shelton WA 98584  
Phone: (360) 426-1020

Peninsular Railway & Lumberman's Museum  
Mailing address:  
Simpson Railroad  
P.O. Box 1333  
Shelton WA 98584



Image by Kent B/Shutterstock.com

High Steel Bridge, a truss arch bridge above Skokomish River in Washington, USA

HAER records give fewer details about the construction of the High Steel Bridge than of the Vance Creek Bridge, but one can assume that the same general methods were used. The HAER description of the Vance Creek construction, written by Lisa Soderberg in August of 1980, includes the following: “The tie-backs consisted of a 2-inch cable which ran from the abutment to a 5-foot sheave at the top of the first panel of the arched section.” It also quotes an article

from the July 11, 1929 issue of *Engineering News* article describing the block and tackle system used as follows: “Passing through the sheave, the cable returned to within about 40 feet of the abutment, where it was attached to an adjusting device used to make final closure. This device consisted of a set of falls made up of two ten-sheave wire rope blocks and 21 parts of 7/8-inch wire rope. The lead line of this set of falls was attached to the anchorage through a long runout turnbuckle, with pin plates and pins so that it could be adjusted without disengaging the positive connection at the anchorage.”

“They quit using the high bridge in 1947, when they cut the line back,” Replinger said. “The Vance Creek Bridge was still in use until 1985.”

In 1964, the addition of a \$64,000 concrete deck converted the High Steel Bridge into a roadway for logging trucks. It remains open for truck traffic and also provides access to some private homes, but the land adjacent to it is closed. The U.S. Forest Service has restricted the areas around both bridges for years because of the danger, and the state considers anyone foolish enough to try to reach the bottom of the steep gorges guilty of criminal trespassing.

What remains of the Vance Creek Bridge presents a serious hazard, with no side rails of any kind and some of the ties removed to discourage trespassing. In spite of barricades and signs stating that people are prohibited by federal order from entering these areas, thrill seekers continue to risk not only their own lives but the lives of those who must rescue them or retrieve their bodies. The Mason County Sheriff's Office has increased enforcement.

For those wanting to experience history in a safe and sane way, the Peninsular Railway and Lumberman's Museum offers a great experience. Incorporated in 2017 as a 501(c)3 public charity non-profit organization, its mission is “preserving and



interpreting the rich railroad and logging history of Mason County, WA.” Former Simpson Railroad Employee Josh Kaivo serves as president. The Simpson Railroad shut down in 2015, and the museum group formed in December of 2016 in the hope of obtaining and preserving the old round house in Shelton.

“Once we knew that wasn’t going to happen, we focused on preserving at least the rolling stock and the railroad to keep that going as a museum,” Kaivo said. “That’s kind of where we’re at now. We’re giving special event rides on our speeders around a two mile loop of track.” The group has repaired a lot of track but is raising money to rehabilitate the rest of the line. “That would give us about a 20-mile round trip, probably about a 1½-2-hour ride when we actually get up and going. I believe it is one of the more technically

interesting tourist railroads in the state,” he said, comparing it to others. “Their railroads are pretty straight, where ours actually winds up and down creek beds and through forests that are still being routinely harvested and then replanted, so they’re in a perpetual working circle.”

Until thrill seekers spread the word about the bridges on the internet, the sensation they caused when built in 1929 had been largely forgotten except by locals. History hides in plain sight all around us and can enrich our lives thanks to people like Replinger, Kaivo, and all the others who share the passion to preserve it for the future.

---

*Author Candace Brown wishes to thank Peter Replinger, Josh Kaivo, Director Elizabeth Arbaugh and Curator Jan Parker of the Mason County Historical Society Museum, and Chief Ryan Spurling of the Mason Co. Sheriff’s Department, for all their help.*



Snow covers the paved surface of the High Steel Bridge these days, but this wintry scene worthy of a Christmas card seems to draw us into the distant past.

Image by Terrence J Allison/Shutterstock.com

**ARE YOU  
LOOKING FOR  
OPPORTUNITIES  
AND/OR NEW  
AVENUES TO  
EXPAND YOUR  
CONSTRUCTION  
OR ROOFING  
BUSINESS?**



***Add commercial roof coatings  
to your existing business and discover  
the unlimited potential!***

Contact us today to find out how to open up new opportunities you never knew existed, and create a whole new level of financial freedom.

**PREMIUM ROOF TEAM**

**1 (855) 550-0009**



**Join a team of roofing contractors  
working together with a  
simple philosophy of *brotherhood,*  
*family and teamwork -*  
**dedicated to your success.****

We provide clear and vital guidance for qualified, hard working candidates seeking their financial freedom. Learn ways to increase income, maintain a work/life balance, bypass unnecessary technology and avoid additional employees.

Full roof training programs available for business start-up & product installation, proven roofing systems, top of the line products and supportive guidance and resources to ensure success to all dedicated individuals.

Don't miss this opportunity, call today to see if this is right fit for you. Openings are nationwide.

We have local events held in multiple communities highlighted with demonstrations and business techniques proven to benefit ambitious minded contractors seeking a sense of continuity, security and financial protection.

**PREMIUM ROOF TEAM**

**1 (855) 550-0009**

**TEAM**

**Together Everyone Achieves More!**

# It pays to invest in a METAL ROOF



*Ultimate Durability • 40-year Finish Warranty • Energy Savings*

82 Garden Spot Road  
Ephrata, PA 17522  
**717-445-6885**  
Toll Free: 800-373-3703  
Fax: 717-977-5175

35 Ridge Road  
Newville, PA 17241  
**717-776-5951**  
Toll Free: 800-782-2712  
Fax: 717-776-0112

M-F: 6:30 am - 5:30 pm  
Sat: 7:00 am - 11:30 am  
Closed Sundays  
abmartin.net



## Manufacturing Quality Carriage Parts Since 1979



**CMS Torsion Axle Undercarriage w/ Airbag Suspension**

*ASK for these products at your local coach shop!*



### Steel Wheels

- **NEW!** 1¼" low profile rubber (comparable to ¼" belting)
- 1¼" layer of rubber with an additional layer of ⅜" flat steel tire on the outside
- Rigorous powder coat process for maximum coating adhesion
- Half round steel or rubber only also available
- Can be purchased separately for regular carriage gears



*NEW style covers & black discs now available!*

*NEW style caliper helps eliminate drag & rattle issues!*

### CMS Hydraulic Disc Brakes

- New style axle bracket is a one-size-fits-both 1" and 1 1/8" axles.
- New design tightens against all 4 sides of the axle (old style only tightened against 2), creating less movement caused by vibration.
- Quickly becoming the popular choice! Existing carriages with drum brakes can be retrofitted with disc brakes.



### Nylon Brake Tubing & Fittings

- Black high-pressure 3/16" nylon brake tubing
- Fittings to fit hydraulic disc or drum brakes

Manufactured by:



250 Maple Ave. Bird-in-Hand, PA 17505

**Call for a catalog!**

**Ask about wholesale & quantity pricing.**





# FOR SALE:



**In Berlin OH • Established in 1978 (43 years)**

**Selling the business which includes:** current dealers, inventory, catalogs, all patterns (47 table styles), more orders than you'll know what to do with! You provide a building, and all our tools are available for purchase, and you will have a booming business, running at full capacity on day 1! You'll be selling tables, chairs, benches & hall trees.

**Contact: Paul Wengerd 330.231.6093**



As an owner of a roofing company, I'm always looking for two most important things in business; **efficiency and safety**. A **Derstine Trailer** is the key to that. We just purchased our second one. It'll take the place of one employee. Any roof with a high eave and steep pitch, it's there. We put all our metal, trim and so forth on it at the shop. We get to the jobsite and raise it to the roof edge. There is no **better, faster, or safer** way than with a **Derstine**. Every roofing company needs one.

**Dennis Schlabach - Owner of D.S. Roofing Systems LLC**

Annual

# PCBE CHARACTER UPDATE

LEROY MARTIN



## Danny Esch- advertising

Allow us to introduce you to Danny, the most recent addition to the PCBE team. In May of 2021, Danny traded his roofing job for an office chair. Although he now strives to obtain great heights regarding customer satisfaction, his primary work occurs on the ground instead of on a steep-pitched roof. He quickly adapted to the office environment and has learned to enjoy the indoor atmosphere. "I was ready to slow down a little, and one of the things I enjoy most about working here is the flexible hours which allow me to spend more time with my wife Miriam and our two children," he said.



Danny and his family live on a farmette, located approximately ten minutes from the PCBE headquarters. In August, the Eschs welcomed their precious daughter Laurel as the latest addition to their family. Two-year-old Jeffrey eagerly embraced the idea of sharing their home with his baby sister. As a father of two, Danny has been tasked with additional responsibilities now.

The Eschs have two dogs, an English Lab and a Poodle, which they raise puppies with. Both dogs enjoy being a part of the family and provide the occasional excitement that surrounds a new litter of puppies.

Danny is considering raising some produce next year. "We aren't sure yet what we want to plant. Probably something

easy to care for, like cucumbers. It will provide us with something extra to do, as a sort of hobby, I guess," he remarked.

Hunting whitetail deer is something that he has enjoyed for several years. Although his hunts occur locally, Danny finds it rewarding to occupy the forests whenever whitetail season rolls around. Last year he managed to score a typical whitetail in proximity to his residence.

Eating a healthy, balanced breakfast is an important way to start his day. "I consider eating a big breakfast as a great way to start the day off right," Danny said.

Reading books pertaining to Middle Eastern history, as well as current events, is a fond pastime of Danny's. He also finds yard work and gardening enjoyable.

## Henry Beiler- graphics design

In addition to his work as a graphics designer, Henry finds woodworking-related activities enjoyable. During 2021, much of his spare time has revolved around building his very own CNC router. He has been building the router from scratch, while relying on information he gathered from instructional materials. It has been a challenge, although a rewarding one. The size of the machine he is building will accommodate a 4x6 piece of plywood. Upon the completion of his ongoing project, he hopes that the router will replace a portion of the work he currently conducts on his bandsaw. During the time I spoke with him,





# A Summary of Events That Transpired in 2021



Drawings by Victoria Yoder

he was unsure when the project will reach its conclusion.

Henry enjoys horses; he purchased a Fresian Standardbred this year. “He is three years old and a quick learner. He is a steady horse, and runs between ten and twelve miles per hour,” he said. Henry is in the process of training him, and feels confident that desirable results will be achieved, after spending additional time with him.

This summer, Henry accompanied friends from his youth group on an excursion to Fox Run Retreat. The group spent three days playing volleyball, softball, as well as other recreational activities. Additionally, he went to Rock Hall, Maryland with some friends for a day of fishing. Their time on the water was an adventure, with a few snagged fish being the added bonus to the day’s events.

Preparing food at the Beiler house has taken on a more serious note recently, with the purchase of his *Traeger* smoker grill. “I am glad I purchased it; it works well for what I want to do. So far, I have only smoked chicken. The biggest project was placing a whole chicken on the grill, and it turned out all right,” he said with a hint of satisfaction.

Henry’s works pertains to graphics designing. He enjoys building new ads and restructuring others, upon client’s requests. He is also active and instrumental in testing new products, of which some are featured in the PCBE.

Hunting whitetail deer is a hobby of his. This year, Henry got a bear tag as well, and is anticipating the possibility of shooting a bear for the first time.

PCBE Update - Continued on Page 88

What began four years ago has evolved into an annual year-end occurrence. Every December, we feature a brief update on the events and highlights that transpired in each of the PCBE team members’ lives throughout the past year.

Since I work remotely and don’t see my colleagues every day, there are events which occur in each of their lives that I know very little about until I sit down with them to gather information which is included in this annual column. It is interesting for me to listen to the stories as each person reflects upon the events of the past year. What struggles did they face or overcome? What successes were they able to achieve?

We strive to find beauty and inspiration in everyday events—even small happenings can possess the ability to affect and transform our lives, if we permit them the opportunity.

From all of us at PCBE, we hope that your year has been a good one, and we collectively wish you a prosperous, safe, and blessed 2022.

—Leroy Martin

### Chris Lapp- advertising

Raising his one-year-old daughter Bethany and working in the advertising department has kept Chris pretty occupied this year. Instead of going on extended hiking trips or embarking on an exciting elk hunt in Colorado, he spent most of his time close to home during 2021.



Purchasing a used portable sawmill was a fun experience for him. He has used it frequently throughout the past year to cut wood from trees that had fallen on his father Elam's property. "I thought it is a shame to let trees go to waste," he said. A team member of his had floated the idea of purchasing a portable sawmill, as a means of salvaging the wood. Several small woodworking projects have emerged since—Chris has made a small swing for Bethany.

Bethany has recently begun walking and enjoys exploring her surroundings. She finds it exciting to tag along with daddy whenever he goes outside to feed the horse, dogs, and goats. Petting the horse during chore-time has become a highlight for her. "She is an outdoor-type of girl," Chris remarked.

The recreational activities for the annual PCBE picnic were hosted at Chris and Mary's place in July. Following a delicious meal at Kountry Essa restaurant in nearby Gratz, a lively game of Cross-net was played by most of the team members, with some individuals exhibiting more competitiveness than others. Playing games with the team members and socializing was a highlight for Chris.

His Bernese Mountain dog, Lexi, has been somewhat of a challenge this past year. She arrived at the Lapp residence at the tender age of nine weeks. Since then, she has become part of the family. Even with her strong personality, Chris has had big plans for her. "I would like to hitch her to a dog cart sometime," he explained. "That would be my ultimate goal with Lexi, besides raising puppies." At this point, it is unclear if Lexi is on board with the idea of being hitched to a dog cart; time will tell.

Chris wishes each advertiser and reader a safe and prosperous year.

### Daniel King- advertising

It's been a good year for Daniel. Readers of last year's column may recall that Daniel had been raising chickens on his property. 2021 brought some changes, and the flock of 1,200 chickens are no longer enjoying their time foraging around the King meadow. "I had been selling eggs for four years," he said. "It was mostly a hobby and something that I enjoyed doing. But this year, I sold all my chickens."



Pebbles, a Bernese Mountain dog, is the most recent addition to the King family. Pebbles is an energetic two-year-old dog and is a lot of fun. Daniel's two-year-old daughter Rose has quickly become best friends with Pebbles. "Rose really enjoys spending time with Pebbles. They enjoy running around in the yard."

Daniel has been involved in the advertising department for two years now, and he relishes his work. He especially likes conversing with clients via phone conversations. Building and nurturing customer relationships is something that he cares deeply about and finds enriching within his work environment.

Not one to shy away from a challenge, Daniel engaged in an unusual task when a team member challenged him to bake a batch of peanut butter cookies. We suspect the individual who put Daniel to the test was very capable of baking cookies for himself. Even so, Daniel took to the kitchen like a good sport and mixed his very first batch of cookies—without much help from his wife Kathryn.

Bowfishing on the Susquehanna River this summer was another highlight of his. "It was fun being out on the water with the team," he recalled. "It was an awesome time, even though it was challenging to shoot the fish." The efforts of the team paid off, and they scored a total of twenty-one fish. Carp, Catfish, and Quillbacks were among the unlucky water dwellers that were snagged by the deftly deployed arrows. The team used compound bows to accomplish the task.

Daniel enjoys eating seafood whenever he has an opportunity to do so. He finds travel fascinating and hopes to travel to Florida sometime within the near future.



### **John Lapp- subscriptions**

A dairy farmer at heart, John still enjoys milking his herd of dairy cows each morning before he steps into the front door of the PCBE office. After his office work is completed, John returns to the dairy barn where he conducts the evening milking. His two youngest sons, Marcus, age 12, and Omar, age 15, also help him. Their help is greatly appreciated and with each passing year, they can perform more and more of the workload. "They have taken on a lot of responsibilities," John remarked with a grateful smile.



John savors the quietness of early mornings when he, using his Millertech headlamp, walks out in the meadow to fetch the cows prior to milking. He begins his day at 4:30 AM.

In September, John went to Ohio, where he toured the Behalt. "I enjoyed learning more about Anabaptist history," he said. "The Behalt's thirty-minute guided tour was very informative and educational."

He was fascinated with learning more about the spark which ignited the Anabaptist movement. "I didn't learn anything from the tour that couldn't have been learned by reading the *Martyrs Mirror* or *Unser Leit*. Which are both books that I have read. But taking the tour helped bring every to life a little better. The tour provided a visual aspect which helped breathe life to the history of the early Anabaptist movement.

John's only daughter Ada Ruth married on November 4<sup>th</sup>. The wedding was held on the family farm, and nearly four hundred guests attended. Several weeks prior to the wedding, John and his wife Amanda and family were busy preparing the property for the four hundred guests, which was a typical number of attendees for an Amish wedding.

"Our daughter will live close by; within walking distance," John explained. "That will be nice."

He helped his eighteen-year-old son Lloyd, who is an avid hunter/trapper, build a 6x6 hunting blind.

Earlier this year, John transitioned from working in the ad department to conducting duties within the subscription department. "I enjoyed the transition," he said.

### **Ivan Lee Lapp- editor**

Among the biggest challenges that Ivan Lee faced this year was when he was entrusted as editor for the PCBE. Raymond had filled those shoes for many years, but due to other responsibilities in his life, Ivan Lee acquired the task of examining and scrutinizing the content that is printed on the pages of our magazine. Such a task includes checking articles for Biblical soundness, conducting fact-checking, looking for future articles that may hold potential interest to readers, maintaining contributor relations, and much more. He welcomes comments from subscribers regarding the quality of the content. "Reader feedback helps to keep us all on track," he shared with me.



He enjoys waking up early each morning on his farmette and drinking a cup of coffee with his wife Anna Mary before starting the day. Before he reports to the PCBE office, he feeds his horses and checks on his herd of beef cows that graze on the fifty-five acres of pasture. Achieving and maintaining good soil health is something he cares deeply about. The cows on his pasture are typically moved once a day; sometimes twice a day if the pasture is in need of a higher stock density for trampling carbon into the soil. This summer, Ivan Lee expanded his existing crossbred herd by buying six Murray Grey cows. The Murray Grey bull which he had purchased last year has produced the first crop of calves in Spring 2021. Watching the energetic calves is a highlight for sons Jared (3) and Merle (1).

Anna Mary and Ivan Lee each have a sister whose weddings they attended this fall. "I enjoy wedding sermons and observing young couples on their wedding day," he told me. "Attending such joyful events and listening to sermons that explain some of the very real responsibilities that a new husband and wife now face, serves as a good refresher course for those of us who have been married for a number of years."

A highlight of the year for Ivan Lee was traveling to the Bruderhof Fox Hills Community in New York. There, he

*PCBE Update - Continued on Page 90*

## PCBE Update - Continued from Page 89

enjoyed observing a community working together in every aspect of their lives. Their communal lifestyle inspired him to apply those same principles to his own life.

### Raymond Lapp- *publisher*

Throughout the past few months, Raymond and his four sons enjoyed the outdoors as much as time permitted. The five of them worked together on a recent project, which consisted of installing A&M Gutter Guards around their house and barn. Raymond is pleased with the results and now anticipates cleaning less leaves from the gutters.



Two dairy sheep still occupy the barn and meadow on the Lapp property. “We have been hand-milking two sheep for the past year and are now looking to expand our flock by fifty percent. We hope to be milking a total of three by next spring.” Raymond conducts majority of the milking. He says milking these gentle animals seems to provide him with time to reflect and meditate. He finds that the task recharges him, and he sees the rewards of putting good healthy milk on the family table. The Lapps are considering purchasing an E-Z Animal Products milking unit by next year. At that point, perhaps one of Raymond’s oldest sons will be required to conduct the milking.

In May, Raymond, traveled to Pearisburg, Virginia with two of his oldest sons and his brother-in-law, John Beiler, who acquired an established business from Sam Chupp. They spent two days touring the Pearisburg area, where they enjoyed visiting with their friend, Sam Chupp. While driving around the area, they accidentally drove into a prison complex and didn’t realize they weren’t supposed to be there until a guard appeared.

With the onset of autumn, several wedding invitations had found their way to the Raymond and Amanda Lapp residence. Weddings are a joyful event, and he enjoys attending while reflecting upon the happiness and solemnity that is associated with such services, as man and wife exchange promises to each other and God.

As the year reaches its conclusion, challenges with the Covid-19 pandemic continue, at least to some degree. “We have experienced paper shortages, as well as disruptions and delays from the company that prints our magazine,” he explained. However, as long as there is paper and ink

available, he is committed to publishing an educational, business-focused magazine that can be delivered to your mailbox each month.

Wishing you all God’s richest blessings as we begin a brand-new year.

### Ivan Lapp- *accounting*

In May, Ivan went to Macon, Mississippi with a small organization for the purpose of conducting relief work. The type of work they performed was not associated with a natural disaster that occurred, rather alleviating the burdens that impoverished communities might experience. During his time in Mississippi, he enjoyed the opportunity of attending church services with the Halteman Mennonite Congregation. “I also enjoyed singing with their youth group,” he said. Additionally, he found it interesting visiting the Choctaw Indian Reservation. Later, members of the Reservation joined Ivan and his friends for supper at the dormitory where they had been staying at.



Working on Leon Yoder’s book: *Leading and Learning* was a fun challenge for Ivan. He consistently collaborated with Ivan Lee and Leon throughout the project earlier this year.

Touring Little Mountain Printing and Dutch Wood in June was another highlight. Ivan enjoys visiting business whenever he has an opportunity. “I find it interesting to see how others do things,” he said.

There were several opportunities for Ivan to participate in bowfishing this year. He accompanied the PCBE team members to the Susquehanna River where they enjoyed a lively evening of bowfishing. He also expanded his bowfishing territory to the Chesapeake Bay, with a group of friends. There, they scored a total of forty-four fish, with one of the fellows managing to shoot two fish with one arrow.

Grilling burgers for hungry hikers along the Appalachian Trail on Peters Mountain was another enjoyable event for Ivan. After preparing a few burgers for the hikers that passed by, he made sure that a dog who was also hiking the trail with its human didn’t go hungry. “The dog preferred not to have its burger grilled,” Ivan explained. Surely, the raw burger was a treat for the dog, and provided sustenance for the long hike ahead.



He enjoyed visiting the Fox Hills Bruderhof Community in New York. “It was very fascinating to see and learn how members of the Bruderhof Communities all work together under a common purse. The Bruderhof have communities throughout the world, and a common purse is practiced and shared, and is not limited to the borders of each country in which their communities are established. Ivan extends his gratitude to Joe Miller and Ken Sensenig of MCC for their coordination in making this trip possible.

### **Andrew Romberger-graphics design**

As the primary caregiver for his eighty-nine-year-old father Rufus, Andrew has learned a lot about caring for older folks this past year. Rufus is currently staying with Andrew and his wife Amy. Finding it a pleasure rather



than a burden to take care of the needy, Andrew doesn't mind at all the additional responsibilities that came his way.

He is thankful that Rufus is still in relatively good shape for his age. “My dad still has a strong appetite,” Andrew said with a chuckle. “He has the appetite of a thirty-year-old man and barely gains any weight. Dad passes the time by occupying himself with puzzle books.”

Andrew's older brother David suffered a stroke earlier this year. As a result, David has passed away from other complications, on Nov. 6, 2021.

When I spoke with Andrew, he couldn't hide the excitement he felt regarding his twenty-four-year-old daughter Sarah's upcoming wedding. The November wedding was a milestone for Andrew and Amy. As the saying goes, their only daughter had now “left the nest.”

This year, Andrew didn't go on any trips, since he has been a caregiver for his father and preparing to give his daughter's hand in marriage.

Graphics designing is a purposeful work for Andrew, and he finds it very fulfilling to create and produce attractive advertisements for clients who advertise in the PCBE. He has enjoyed and excelled in this line of work for more than thirty-eight years. Andrew enjoys the working relationship that he has with team member Henry. “He was a good add-on,” Andrew said. “We have similar personalities and get along quite well.” Andrew values working with each member of the advertising department.

When Andrew first started working for PCBE in 2012, the monthly magazine consisted of less than sixty pages. For perspective purposes, the magazine has recently surpassed the three-hundred-eighty-page mark.

Andrew still raises blueberries and enjoys caring for his crop. Each summer, a list of established clients anticipates purchasing and enjoying the sweet fruits of his labor.

### **Leroy Martin- contributor**

This past year consisted of a greater amount of traveling than the previous one had. Leroy went on several trips in 2021, meeting with various business owners throughout the Midwest, Northeast, as well as some southern regions of the United States.



Staying right in step with many other members of the PCBE team, he raised two litters of puppies with his Havapoo, Tootsie. He spoiled the puppies with treats and toys right up until the minute they were rehomed.

Early in the year, he had made a commitment to hold physical exercise in lesser disdain than he had throughout the past three years. Thus, he became a bit more active. Pedaling his bicycle to the Millersburg, Pennsylvania headquarters from his place of residence in Lancaster County, proved to be exhaustive. Even so, a few months later, he once again occupied the bicycle seat for an even longer journey during the middle of an intense July heat wave. This time, his destination was Penn Yan, New York. After that journey had reached its conclusion, the bicycle was placed in the shed where it could rest up for several months.

The much-talked-about virus found its way to his house in January. The unwelcome guest stayed with him for more than two weeks and was seemingly unrelenting. Throughout the ordeal, he found it difficult to remember a time when he had felt as ill.

Leroy continues to enjoy photography, writing, and traveling. It is, in part, the people that he meets throughout his journeys that are the source of his inspiration and encouragement. Listening to some of the struggles that folks have overcome, solidifies the notion that, with God's help, we can rise above great obstacles that may stand in our paths.

---

Researched, written, and edited by *Leroy Martin* for the exclusive use of the *Plain Communities Business Exchange, LLC*.

# Want Clean Air?



## Removes:

- Welding/Diesel Smoke • Coolant Mist
- Woodworking Dust
- Grinding Dust • Paint Overspray



OSHA COMPLIANT  
**AIR=VAC**  
SYSTEMS

## Destroys:

- Heavy Odors • Toxic Gases
- Chemical Fumes • VOC's
- Carcinogens • Mold, Viruses, Bacteria

Call 800-234-2473 or Rob at 319-231-4711

[www.air-vacsystems.com](http://www.air-vacsystems.com)

# FASTENERS • Retail and Wholesale



COIL NAILS, STICK NAILS, BULK NAILS  
STAPLES, BRADS, SPECIALTY FASTENERS  
TAPCON, RAMSET and STRUCTURAL SCREWS



PLEASE CALL FOR PRICING AND AVAILABILITY  
PLEASE HAVE PART NUMBER WHEN CALLING

**Air Works III LLC**  
Tools\*Fasteners\*Supplies

6773E 750N, Odon, IN 47562 – 812-687-7337

# HOT OFF THE PRESS!

## 2022 CALENDARS

## ORDER YOURS NOW

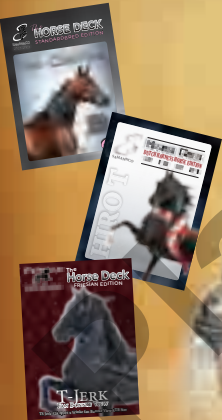

\$12 each or 2 for \$20  
Plus local tax and 15% shipping.  
or call for wholesale pricing for your store or farm.

WE ALSO DO CUSTOM BOTTOM FLAP CALENDARS

Bottom flap free with orders of 50 or more



5162 Parks West Rd Middlefield, Ohio 44062  
**(833) 693-4144**

Also, don't forget to order the rest of our products!  
2022 MultiBreed Calendars • 2022 Friesian Calendars • 2022 DHH Calendars  
Standardbred Horse Decks • DHH Horse Decks • Friesian Horse Decks

# A DEPENDABLE HEATING SOLUTION FOR YOUR GREENHOUSE

non-electric propane or natural gas



## Blu Flame heat:

- ✓ Peace of mind
- ✓ Healthy plants
- ✓ Even, consistent heat
- ✓ Reliable heat source
- ✓ A good night's sleep
- ✓ Safe

Puppy Heaters



Residential Heaters



Custom Heaters



**BLU FLAME HEATERS, LLC**

CALL TODAY  
**(610) 593-0337**

1634 Valley Rd., Christiana, PA 17509



# Step Up to a Better Boot this Winter.

## Try These Brands On and Feel the Difference!



**Ask Your Local Dealers About These Brands!**

**Arkansas**  
Pine Creek General Store | Salem  
**Colorado**  
Farmstead Supply | Monte Vista  
**Delaware**  
Miller's Harness & More | Hartly  
**Illinois**  
Brenneman's Country Store | Sumner  
Hillside Wood Products | Cuba  
Hilltop Shoe Store | Xenia  
Lone Star Fabrics | Ava  
Martinsburg Market | Pleasant Hill  
O&S Tack Shop | Opdyke  
R & M Enterprises | Arcola  
Stutzman Variety | Plymouth  
Yoder's Woodworking | Oblong  
**Iowa**  
Bear Creek Archery | Edgewood  
Blue Spruce Variety | Northwoods  
Community Country Store Annex | Kalona  
Daniel's Misc. | Milton  
Gingrich Building Materials | Chariton  
Gingrich Fabrics | Murry  
Graber's Country Store | Bloomfield  
Hartwick General Store | Delhi  
Helmuth Saddle Shop | Independence  
Horseshoe Ridge Variety | Edgewood  
Livestock Systems | Charles City  
Mormon Trail Store | Seymour  
Petersheim Harness | McIntire  
R&S Harness & Farrier Supply | Kalona  
Rocky Ridge Harness | Cresco  
Yoder's Shoe | Davis City  
**Indiana**  
A&A Sales | Monroe  
Amos Graber & Sons | New Haven  
Burkholder Country Store | Nappanee  
Brushy Fork Variety | Canaan  
Country Acre Woodworking | Connorsville  
Countryroad Fabrics & Shoes | Shipshewanna  
DA Footwear | Berne  
Eash Harness Supplies | Millersburg  
Eicher's Leather Shed | Bryant  
Esch Ag Supply | Fountain City  
Edward Hochstetler | Nappanee  
Graber's Country Store | Spencerville  
Heritage Fabrics | Nappanee  
Heron Creek Supply | LaGrange  
Laura's Fabrics | Middlebury  
Lehman's Variety Store | LaGrange  
Long Lane Harness | Rochester  
L&R Footwear | Topeka  
Maple Leaf Country Store | Monroe  
Maple Leaf Tack | Orleans  
Miller's Ag Products | Kokomo  
Miller's Country Store | Grabbill  
Miller's Dry Goods | Fountain City  
Miller's Shoes | Montgomery  
Millersburg Feed | Millersburg  
Milroy Shoes | Milroy  
M&R Sales | Nappanee  
Pine Ridge Variety | LaGrange  
Schwartz Shoe Store | Monroe  
Schwartz Shoe & Variety | Salem  
Stringtown Shoe Store | Goshen  
Wagler's Variety | Montgomery  
Wickey's Harness Shop | Canaan  
Zehr Shoe LP | Grabbill  
**Kansas**  
J.K. Harness Shop | Dennis  
**Kentucky**  
A&S Country Store | Glasgow  
Blue Grass Leatherworks | Oak Grove  
Blue Grass Variety | Bethel Ridge  
Cedar Creek Harness | Lewisburg  
Danny Byler | Wingo

E&L Horse Supplies | Smith's Grove  
Moses J Gingerich | Upton  
Hillcrest Variety | Carlisle  
Little Bitty Farm | Cadiz  
L&K Variety | Liberty  
Mill Creek Tack | Turners Station  
Ottenheim Country Store | Waynesburg  
Pin Oak Farm | Mackville  
Trenton Farm Supply | Trenton  
Valley View Outdoors | Scottsville  
Vernon Community Leather Shop | Hestand  
Yoder's Woodcraft | Leitchfield  
**Maryland**  
Esh Shoes | Mechanicsville  
Oak Woods Shoes | Mechanicsville  
**Maine**  
Unity Community Market | Unity  
**Michigan**  
Big D's Bike Shop | Centreville  
Bloomingdale Farm Supply | Bloomingdale  
Byler Dry Goods | Six Lakes  
Emanuel Byler | Cornell  
Chupp's Herbs and Fabrics | Burr Oak  
Countryside Sales | Cass City  
Countryside Variety | Homer  
Family Footwear | Manton  
Farm Lane Footwear | Stanwood  
Findley Variety | Burr Oak  
Gary Henckel | Mendon  
Graber's Sales & Service | North Adams  
Menno Lengacher Jr | Hillsdale  
Shady Lane Shoes | Mio  
Tobacco River Footwear | Clare  
Troyer's Leather | Fremont  
Weaver's Variety | Gladwin  
Whispering Pines Farms | Whittemore  
Kevin Yoder | Vermontville  
Yoder's General | Brown City  
Yoder Feeds | Leslie  
Yoder Supplies | LeRoy  
**Minnesota**  
Beachy's Bargains | Bertha  
Hershberger's Footwear | Canton  
Northland General Store | Clearbrook  
Plainview Variety | Winger  
Scott's Genetics & Livestock Equipment | Hinkley  
Slabaugh's Footwear | Long Prairie  
The Country Store | Sebeka  
John Weaver | Lengby  
**Missouri**  
Bridge Creek Sales | Knox City  
Country Health Products | La Plata  
Nolan Diller | Rutledge  
East View Sales | Barnett  
Eicher Farm Store | Curryville  
Elmrose Essentials | Chula  
Fred Frey | Alexandria  
Graber Metal Sales | LaRussell  
Hershberger Shoes N More | Prairie Home  
H&S Craft/Variety | Seymour  
Hwy W Sales | Stanberry  
Jamesport Farm Supply | Jamesport  
Meadow Lane Store | Windsor  
Midwest Saddlery | Spickard  
Niangua River Outdoors | Tunas  
Northwest Metal | Bethany  
Orchard View Products | Queen City  
Osage Valley Harness | Rich Hill  
Ozark Variety | Dixon  
Rolling Acres Variety LLC | Moberly  
Schwartz Harness Shop | Licking  
The Outpost | El Dorado Springs  
Triple H Feed | Miller  
**Mississippi**  
U&M Footwear | Randolph

**New York**  
Brutus Farm & Country | Weedsport  
Coblentz Footwear | Conewango Valley  
Country Knob Shoes | Clyde  
Edgewood Country Store | Penn Yan  
Dan Hershberger | William  
Family Reflections | Bickenson Center  
Finger Lakes Dairy | Seneca Falls  
Girod's Harness & Repair | Houghton  
Hilltop Leather Goods | Marathon  
Hilltop Variety | Holland Patent  
HR Footwear | Wellsville  
Locust Lane Harness Shop | Romulus  
Maple Ridge Harness | Panama  
Miller's Country Store | Burke  
Rennos Boots | Groton  
Dennis Shetler | Willsboro  
Sunset Farm Tack & Harness | Medina  
Jonas Troyer | Earlville  
Twin Maple | Fultonville  
Valley View Harness | Belfast  
Henry Yoder | Huevelton  
Yoder Manufacturing & Sales | Addison  
**North Carolina**  
Ellenboro Tack & Repair | Ellenboro  
**Ohio**  
Berlin Leather | Millersburg  
Cedar Creek Leather Shop | Bellville  
Charm Harness & Boot | Charm  
Cornerstone Merchandise | Shiloh  
Country Trim | Fredericksburg  
Danville Harness Shop | Danville  
Farm Family Basics | Winchester  
Farmerstown Shoe N Gift Shop | Baltic  
Grand Valley Footwear & Outdoor | Orwell  
Hershberger's Shoes & Boots | Chesterhill  
Hidden Acres Footwear | Big Prairie  
Home & Heart Variety | Adamsville  
J&S Yoder Dry Goods | Homerville  
Jerusalem Variety | Jerusalem  
Daniel Keim | Ashland  
Keim Woodcraft | Gallipolis  
Loudonville Farm Supply | Loudonville  
Mel's Shoes N More | Middlefield  
Miller's Footwear & Variety | Sugar Creek  
Mt Hope Harness & Shoe | Mt Hope  
Mullet's Footwear | Middlefield  
Mullet's Harness Shop | Middlefield  
New Bedford Harness | Baltic  
Raber's Harness & Shoes | Oak Hill  
Raber's Harness & Supply | Millersburg  
Raber's Shoes | Peebles  
RML Boots & Shoes | Fredericktown  
Splintered Arrows Taxidermy | Hicksville  
Stauffer Harness Shop | Hillsboro  
Stoltzfus Variety | Middlefield  
Walnut Hill Feeds | Shelby  
Weaver Shoe Shop | Apple Creek  
**Oklahoma**  
Creekside Sales | Choteau  
**Pennsylvania**  
Byler's Shoe Variety | Jackson Center  
Centerville Shoe & Harness | Centerville  
Clarion Family Fabrics | Sligo  
Countryside Designs | Sugar Grove  
Creekside Footwear | Port Trevorton  
C&S Country Store | Newburg  
Elmsport Supply | Allenwood  
Eli Hochstetler | Atlantic  
Feed&Supply Center | Northern Cambria  
Good's Store | East Earl  
Good's Store | Quarryville  
Good's Store | Schaefferstown  
Good's Store | Ephrata  
Green Tree Hardware | Quarryville  
Hochstetler Shoes | Venus

Kauffman's Store | Loganton  
Keystone Supplies | Atlantic  
Levi Weaver | Smicksburg  
Martin's Farm Supply | Greencastle  
Mifflinburg Variety Store, LLC | Mifflinburg  
Mills Hill Variety | Ullyses  
Mountainside Shoe Shop | Belleville  
Mountain View Ag & Equine | Mt Pleasant Mills  
Neal's Harness Shop | New Wilmington  
Peachey Harness & Farm Supply | Belleville  
Pleasant Valley Country Store | Kirkwood  
Ridge Road Country Store | Beaver Springs  
Schwartz Country Store | Springboro  
Schwartz Farm Supply | Silgo  
Shetler's Sewing Shop | Union City  
Valley Brook Dry Goods | Meyersdale  
Valley View Farm Supply | Mifflintown  
Weaver's Farm Supply | Fleetwood  
Weaver's Merchandise & Shoes | Centerville  
Yoder's Harness & Shoes | Reynoldsville  
**Tennessee**  
Borntreger Harness & Saddle | Buchanan  
Cedar Home Shoes | Ethridge  
David's Wheel Shop | Summertown  
J & K Footwear | Stantonville  
Mountain Hardware | Spencer  
Miller's Country Store | Holladay  
Quality Feed & Tack | McKenzie  
Shetler's Shoes | Delano  
Tellico Bluff Fabrics | Tellico Plains  
**Vermont**  
Rudy Kauffman | Orlean  
**Virginia**  
Burkes Garden General Store | Tazewell  
Cedar Creek Farms | Cullen  
King's Kountry Store | Nathalie  
Rough Creek Outdoors | Charlotte Courthouse  
Cottontown Varieties | Farmville  
The Shoe Shed, LLC | Mt.Crawford  
**Washington**  
Farm & Home Hardware | Basin City  
**Wisconsin**  
A-N-R Sales | Blair  
Bridge Creek Variety | Augusta  
Clearview Country Store | Baldwin  
Countryside Bent & Dent | Albany  
Countryside Fabrics | Sparta  
D&S Bulk Foods & More | Kennan  
Eddie Stutzman Shoes | Curtiss  
Four Corners Variety | Soldiers Grove  
Garmen Clothing Store | Colby  
Gingrich Woodshop | Fairchild  
Hank's Farm & Food | Sheldon  
Hillside Country Store | Reedsburg  
Hilltop Repair | Dalton  
Maple Drive Harness | Viroqua  
Mapleleaf Variety Store | Gilman  
Martin Farrier Supply | Thorp  
Miller's Engine Repair | Lancaster  
Miller's Footwear | Loyal  
Pinecrest Farm Supply | Athens  
Pleasant Hill Supply | Chetek  
Preston Valley Farm Shop | Fennimore  
Rockcreek Sales | Greenwood  
Salem Ridge Footwear | LaFarge  
SL Sales | Platteville  
Sunny Ridge Sales | Tomah  
Trail Lane Sales | Loganville  
Twin Lakes Store | New Auburn  
Twin Oak | Clintonville  
Yoder's Fabrics | Wautoma  
Yoder's Farm Supply | Westby  
Yoder's Repair | Rice Lake  
**West Virginia**  
Forest Hill Community Sawmill | Ballard  
Peachey Shoe Store | Letart

*If your community is not represented on this list and you are interested in becoming a dealer, please contact us!*

**Bag Man, LLC PO Box 162 Hammond, WI 54015 | Phone: 800-796-5333 | Fax 715-796-5655**

# DURAND THE DURABLE:

The shoe that **ENDURES** just like you!

## KEEN DURAND II



Tough Shoe • Leather Upper • Waterproof



**269-659-3950**

27539 Londick Rd  
Burr Oak, MI 49030

7½ miles north of  
Sturgis, MI via M-66

AND COMPONENTS

Fine Custom Cabinet Doors



2902 MILLER LANE • BIRD-IN-HAND, PA 17505

717-768-7613 • FAX 717-768-7697

Call for free price list catalog

# THIS IS FOR YOU.

**IF YOU** want to work in an Anabaptist environment.

**IF YOU** are talkative and can make conversation with anyone.

**IF YOU** have a passion for sales and marketing.

**IF YOU** enjoy managing projects and people.

**IF YOU** are the innovative, forward-thinking person we are looking for.



If you think this is for you,  
get in touch with Steve at  
330.473.2053 or  
SLeid@hhccustomhomes.com

## Aquamonics

DIGITAL WATER SYSTEM  
WATER WITH A PURPOSE

Are you concerned about your water

**CHANGE YOUR WATER,  
THE WAY IT IS MEANT TO BE.**

*Aquamonics Water System, improving your  
water for animals, plants and humans.*

- Units that treat the water for your entire home or farm
- A whole house water system
- Agricultural water System
- Commercial water System

**We also have an Anti-Scaling unit.**

— We are using the combination of the Aquamonics water treatment with the addition of electrons to the water to create a condition where the minerals that traditionally create the problems of hard water and scaling are changed. Their chemical structure is reduced by the addition of these electrons. This creates desirable new conditions without the use of salt or chemicals and without the wasted water associated with reverse osmosis or ion exchange systems. Although the minerals are NOT removed from the water, the problems associated with their presence disappear.

### Testimonial

— July of 2021, we installed an upgrade Aquamonics Digital unit. (As it was time to refurbish our Talya unit.) I had a rash on both of my feet, on either side of my feet & within 3 weeks the rash is almost gone on both feet. We had a problem with worming the pups, & they had loose stool or scours. We Don't need to use as much antibiotics anymore, & now it doesn't take as much wormer either, it isn't a battle like it was before. So now we have overall better puppy & human health. We would not want to be without it, I would recommend it to anybody, & everybody. We had the same problem in 2014, before we got the unit. When we initially put the unit in everything cleared up. Thanks again Enos for an upgraded Digital Unit. Start with good water for good health.

Jake K. Myerstown

### E.L. Petersheim

Distributor of an  
Aquamonics Digital Water System, &  
installing it right on your Farm or Home

Enos L. Petersheim  
366-B S. Belmont Rd  
Paradise Pa 17362

717-723-7768







10550 Township Road 262

Millersburg, Oh 44654

Phone 330-674-4003

Fax 330-674-4035

Acu-form@safecommail.com

WWW.ACUFORMEQUIPMENT.COM



◇ Ag Panel

◇ Ridge Cap

◇ Hemmer

◇ Slitter

◇ Uncoiler

◇ Corner

◇ J Channel

◇ Rat Guard

◇ Wrappers

◇ Trim Wrapper

◇ Rolls and Tables

◇ Post Cut Shears



*A lodge like no other*



Centered on 29 acres of land and shaded by a canopy of oak trees, this warm and rustic property boasts an astonishing 11 bedrooms and 12.5 baths, 2 fully-furnished kitchens, large living room, walkout basement with patio, dining area, and lounge.

A large wrap-around porch allows you to enjoy the beautiful views no matter what season you are visiting. In addition, Cozy Oaks has two lakes, hiking trails, spikeball, cornhole, steel quoits, a volleyball court, and abundant wildlife viewing.

Located in Edina, Missouri, this amazing jewel is available for rental year-round.

*For reservations, please contact*  
660-342-1230 or [cozyoakslodge@gmail.com](mailto:cozyoakslodge@gmail.com)

54711 STATE HWY K, EDINA, MO 63537

# Goldendoodles, Bernedoodles, Mini Poodles



## GREENBRIER HOMESTEAD "Elite Genetics"

Taking Orders for Upcoming Litters  
Creative Financing & Payment Options

### NOW STANDING AT STUD

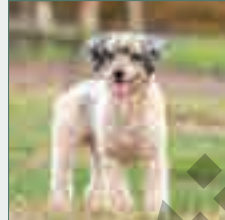

**Greenbrier Grinder**  
**ACK Mini Poodle**  
13 lb E/E at/at ky/ky B/B sp/sp M/m  
No Cream, Completely Health Clear

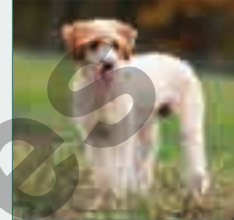

**Pete: AKC Mini Poodle**  
12 lb e/e at/at ky/ky B/b sp/sp  
Intense red Completely health clear.

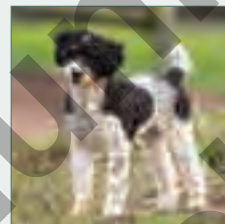

**Pow Wow ACK**  
**Mini Poodle**  
12 lb E/e at/at ky/ky B/B sp/sp  
Vivid points.



**The Mighty Captain**  
**AKC Standard Poodle**  
E/e at/at ky/ky B/b sp/sp M/m  
Completely health clear

### Previous Puppies

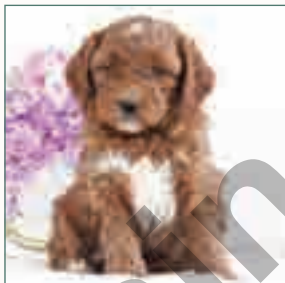

**Lucky, Goldendoodle**  
Intense Red, Axle Son, No Parti



**Lady, Goldendoodle**  
No Parti, Intense Red

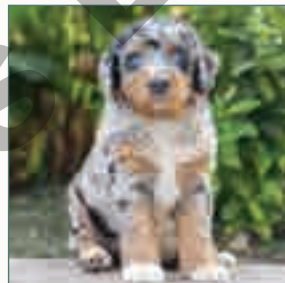

**Mandy, Bernedoodle**  
No Cream or Parti



**Casey, Bernedoodle**  
No Cream or Parti

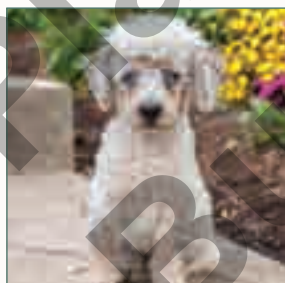

**Lincoln, AKC Mini Poodle**  
Merle — Two Blue Eyes  
Completely Health Clear



**Elijah, Mini Poodle**  
20 lb, Red Parti Male

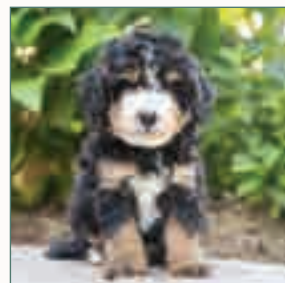

**Ben, Bernedoodle**  
No Cream or Parti



**Tammy, Mini Poodle**  
Female



717-678-0247



## Puppies Available Now



**Marcy, Mini Goldendoodle**

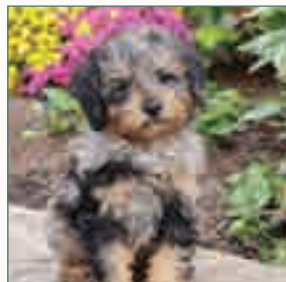

**\*Indigo, Merle Tri  
Mini Poodle Male**  
*E/e At/At Ky/Ky B/b S/sp M/m*

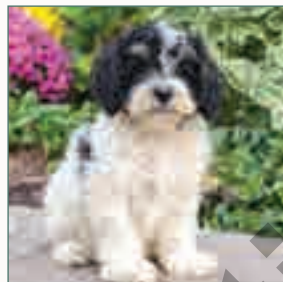

**\*Israel: Mini Poodle**  
*Em/e At/At Ky/Ky B/b sp/sp*

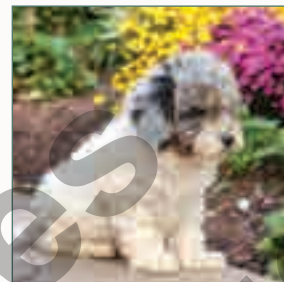

**\*Incredible: Mini Poodle  
Male**  
*E/e At/At Ky/Ky B/b sp/sp M/m*

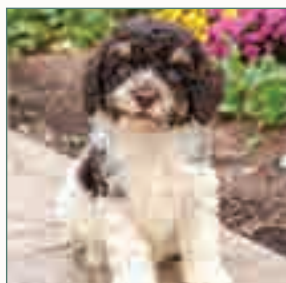

**Rambo, Mini Poodle**  
*Em/E At/At Ky/Ky b/b sp/sp*

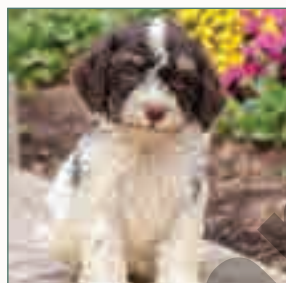

**Riley, Mini Poodle**  
*At/At Ky/Ky b/b sp/sp*

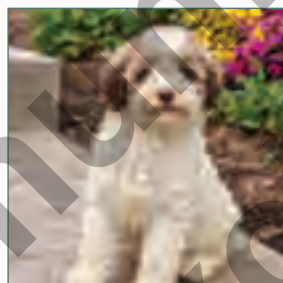

**Waneta Mini Poodle**  
*Em/e At/Ay Ky/Ky b/b sp/sp*  
*Completely Health Clear*

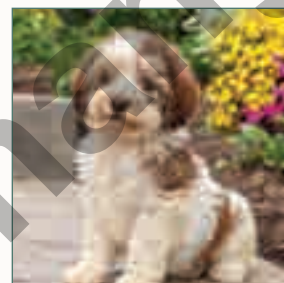

**Rosy Mini Poodle**  
*E/e At/Ay Ky/Ky b/b S/sp*  
*Completely health clear.*

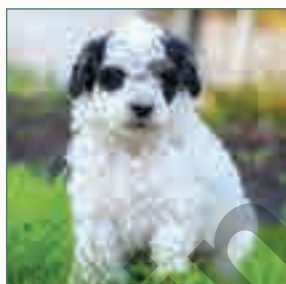

**Copper Mini Poodle**  
*AKC Male*



**Callie Mini Poodle**  
*AKC Female*



**New Litter: Black, Chocolate,  
Merle Tri Mini Poodles, vivid points**

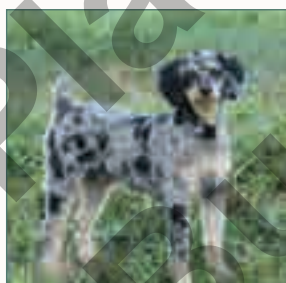

**Twilite M Poodle**  
*1 yr old. E/e At/At Ky/Ky*  
*B/b S/sp M/m*  
*Excellent Mother\**

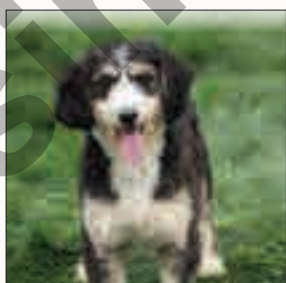

**Bella Mini Bernedoodle**  
*expecting Mother to Blue Merle Tri.*  
*E/e At/At Ky/Ky B/B S/sp*  
*Excellent Mother*



**New Litter: Black / Blue Merle Tri  
Standard AKC Poodle Males**

**ONLY A PARTIAL LISTING  
CALL ABOUT MORE  
OPTIONS**

**717-678-0247** For current updates, call  
or email [greenbrierpuppies@gmail.com](mailto:greenbrierpuppies@gmail.com)

# WHO DO YOU WORK FOR?

## WE WORK FOR MORE PEOPLE THAN WE REALIZE



CALEB CRIDER

**T**

he question “Who do you work for?” is not as simple to answer as it first seems. The first answer, of course, is our employer, whether that is a person or a company. But if you take the question a bit deeper, you realize that the following answers are also true:

1. I work for my boss.
2. I work for my customers.
3. I work for my family.
4. I work for my coworkers.
5. We could even say that we work for God, because the Bible tells us to work “as unto the Lord” and that we “serve the Lord Christ” (Colossians 3:23-24).

Our perspective on work affects our success at work. It affects how we relate to others at work and affects how much we enjoy work. Let’s briefly look at each of these five aspects of working for or serving others.

### **Working for the boss.**

We work for the boss because we want him to pay us. But that’s only the beginning. We should take the responsibility to see the bigger picture,

care about our boss’s objectives, and make the boss’s job easier.

During World War II, a general serving under General Dwight Eisenhower kept making ill-advised comments in public. Eisenhower wrote to his wife, “That man is going to drive me to drink. He misses more opportunities to keep his mouth shut than almost anyone I ever knew.”

Someone who works only for pay is called a *mercenary*. Robert Glazer writes about this kind of employee in a recent article entitled “Workplace Individualism:”

“Employees are clear that they do not want to work for mercenary leaders. However, organizations need to develop their approach and response for what is essentially a mercenary employee: someone who cares first and foremost about what is best for themselves, irrespective of the impact on others, or on the organization as a whole.”

### **Working for customers.**

What do you think about as you work? Work can get tedious, but occasionally thinking about our customers adds meaning to what we are doing.



Even if you work in the back office or in the back forty or in the back of the factory with no customer contact, knowing that you are helping to produce useful products for real people can make your work more enjoyable.

### Working for our families.

You've likely heard the children's story *The Three Little Pigs*. I still remember the vivid pictures of the big, bad wolf from the storybook my mom read to us as children. In case you are not familiar with it, here is a short version:

Three little pigs set off to find their way in the big world. Two of them are lazy. They each hurriedly throw together a house, one of straw and one of sticks, so they can play. The third pig does the job right, taking extra time and building his house out of brick.

The big, bad wolf visits the home of the first pig, and destroys the house made of straw. The pig runs to his brother's house of sticks for safety. But the big, bad wolf destroys the house of sticks too. The two pigs race to the third brother's house of bricks. The big, bad wolf tries his hardest, but he is not able to knock down the house of bricks.

Now, I know that is just a children's fable, but it teaches some valuable lessons. The lesson I want to point out here is that the third little pig's willingness to put in the time and work instead of play benefited not just himself, but also others.

### Working for our coworkers.

Jesus said that the person who serves the most—not the one who gets paid the most or who occupies the highest position on the org chart—is the greatest (Matthew 20:26).

Here are several ways you can work for your coworkers:

1. Do things that make your coworker's job easier, especially the person who handles the next step in the workflow.
2. Cheerfully answer questions and contribute your expertise when someone asks for help.
3. If you are in a position to choose which parts of your daily workload to prioritize, whenever you are able, prioritize work that allows your coworkers to move ahead with their projects.
4. Be responsive to emails and phone calls from your coworkers.
5. Ask for relief when you can't complete your work. Charles Boyle said, "If not controlled, work will flow to the competent man until he submerges." You cannot serve your coworkers and customers well when you are buried under a pile of unfinished work.

Our perspective on work affects our success at work.

I give these suggestions with the understanding that it is possible to neglect our own responsibilities by trying to help our coworkers too much. That's a mistake we need to avoid.

Adam Grant wrote a whole book devoted to the idea that helping others helps ourselves. In *Give and Take* he says, "Extensive research reveals that people who give their time and knowledge regularly to help their colleagues end up earning more raises and promotions in a wide range of settings, from banks to manufacturing."

Helping others at work has a positive boomerang effect, returning to benefit ourselves in many ways besides the potential for promotions.

### Conclusion

Writer Anne Dillard observed, "How we spend our days is, of course, how we spend our lives." Work is an important part of our lives, partly because we spend so much time there. Understanding that we are serving others beyond ourselves with our work helps make work worthwhile.

*Is relating to your coworkers hard work? Make your job a little easier by reading Caleb's book **Getting Along at Work**. Order your copy today!*



**Invest in your career.**

You'll go farther and enjoy it more when you learn how to successfully work with people.

Order from Carlisle Press or buy from your local bookstore. 800-852-4482  
2673 Township Road 421, Sugarcreek, OH, 44681  
**\$12.99 + \$4.95 S&H.**

Get the ebook instantly at Amazon.com.

**Probably the reason we all go so haywire at Christmas time with the endless unrestrained and often silly buying of gifts is that we don't quite know how to put our love into words.**

~Harlan Miller

# NAME BRAND CLOSEOUT FOODS

Banana Box - Groceries, Banana Box - H.B.A., Case Lots - Paper Products, Cleaning Products, Laundry Detergent, Canned Goods

**TRUCK LOADS:** Barn Siding, Tools, Lumber, Landscape Stone, O.S.B.

We ship from our warehouse or direct ship.

~ WHOLESALE ONLY ~

## HOLMES SURPLUS CENTER

Owners: Stephen & Erna Miller

Business: 1299 US RT 62 • Wilmot, OH 44689 | Mailing: 7181 TR 665 • Dundee, OH 44624

phone: 330-359-6238 • cell: 330-464-0378 • fax: 330-473-1666 • hours: Monday-Friday 8:00-4:00

Tired of your dirty old  
**MUDSPLASHER?**

**NEW**  
Bike  
Mud Flap

MANUFACTURED AT:

**Mtn View  
Ag & Equine**

260 Troup Valley Hill  
Mt. Pleasant Mills, PA 17853

Custom made Harness • Mini to Draft

TRY ONE OF BETTER QUALITY MADE OF PVC!

**Why should I buy this mudsplasher?**

• It's proven to last longer • It's easy to clean • Doesn't fade in sunlight

Accepting  
New  
Dealers!

**570-539-2102**

### AVAILABLE AT:

**A & A Carriage & Wheel**  
214 N Shirk Road  
New Holland, PA 17557  
717-355-9182

**A & M Buggies**  
17754 E. L. Hwy 142  
Opdyke, IL 62872  
618-244-1395

**Alleona Buggy Shop**  
E 16231 St John Ave  
Hillsboro WI 54634

**Andy Yoder**  
2639 Campbell Road  
Brown City, MI 48416  
810-346-3187

**Ashrey Buggy Shop**  
4028 CR 200  
Fredericksburg, OH 44627  
330-275-0203

**Back 40**  
1525 Barkers Mill Rd  
Pembroke KY 42266  
270-439-0454

**Beiler Carriages**  
30 Bailey Crossroads Road  
Cochranville, PA 19330  
610-593-7378

**Belmont Acres Carriage**  
366A S. Belmont Road  
Paradise, PA 17562  
717-687-0574

**Bontrager Custom Carriage**  
1842 200TH ST  
Promise City IA 52583  
641-203-0320

**Bowmansville Coach**  
210 Laurel Road  
East Earl, PA 17519  
717-445-9963

**Breezy Hill Carriage**  
3793 Breezy Hill Road  
Fennimore, WI 53809

**Breezewood Buggy**  
2740 E Gap Hill Road  
Cub Run, KY 42729  
270-524-2740

**Bricker Carriage**  
6739 Bricker Road  
Hubbardston, MI 48845  
989-637-4091

**Buckeye Welding & Mfg.**  
2507 TR 110  
Millersburg, OH 44654  
330-674-2585

**Byler Wheel Repair**  
23558 Path Valley Road  
Doylestown, PA 17219  
717-349-7083

**Cedar View Carriage**  
3621 Sugar Hill Road  
Ava, IL 62907  
618-559-1710

**Centre County Carriage Shop**  
178 Turkey Drive  
Rebersburg, PA 16872  
814-349-1241

**Christian E. Lapp**  
125 Reed Road  
Spring Glen, PA 17978  
717-365-4022

**C&L Carriage**  
212 Osceola Mill Road  
Gordonville, PA 17529  
717-768-3229

**C-Mor Carts**  
19 Walker Lane  
Kinzer, PA 17535  
1-866-580-5521

**Country Corner Carriage**  
7468 Albro Rd  
Gainesville NY 14066  
585-493-2124

**Country Lane Coach**  
700 Country Lane  
Paradise, PA 17562  
717-442-2933

**Country Side Carriage**  
1575 Country Highway 12  
Cinse, IL 62823  
618-599-3424

**Creekside Carriage**  
435 Maple Shade Road  
Kirkwood, PA 17536  
717-529-6001

**Creekside Carriage**  
9315 TR 560  
Homesville OH 44633  
330-674-5677

**Country Coach**  
N 16242 Sidney Ave  
Withee, WI 54498  
715-229-4553

**Country Side Coach**  
3757 Pleasant Plain Road  
Williamsburg, IN 47393

**Dave's Buggy Shop**  
232 Big Windy Road  
Cub Run, KY 42729

**Double E. Carriages**  
40 N. Harvest Road  
Bird-In-Hand, PA 17257  
717-768-8484

**EFG Custom Carriage**  
58644 280th Street  
Deer Creek, MN 56527  
218-639-3163

**Elroy Ebersole**  
6573 RD 140 RR2  
Milverton ON NOK IMO  
519-595-7701

**Ervin Yoder**  
683 E Nobob Rd  
Summershade KY 42166

**Esh Carriage**  
171 Beiler Drive  
Rebersburg, PA 16872  
814-349-5957

**Farmersville Buggy Shop**  
471 N. Farmersville Road  
Ephrata, PA 17522  
717-859-5841

**Farmwald Buggy**  
8319 Kerry Rd  
Manistee MI 49660  
231-655-2348

**Fairview Coach**  
615 Evans Road  
Litzitz, PA 17543  
717-665-5713

**Finger Lakes Buggy Shop**  
2621 CR 139  
Ovid, NY 14521  
315-209-3726

**Country Lane Coach**  
700 Country Lane  
Paradise, PA 17562  
717-442-2933

**Fisher's Buggy Shop**  
63 Buggy Shop Lane  
Loganton, PA 17747  
570-725-2704

**Fulton County Carriage**  
7640 N 150 W  
Rochester, IN 46975  
574-892-5833

**Glick Brothers  
Carts and Carriage**  
225 Troup Road  
Millersburg, PA 17061  
717-884-6113

**Grey Wolf Enterprise**  
5856 RT 414  
Romulus NY 14541  
667-222-5602

**Hershberger Buggy Shop**  
46596 Drake Rd  
Graysmills WI 54631  
608-306-1571

**Hickory Drive Coach**  
30376 Hickory Drive  
Platteville, WI 53818  
608-348-2132

**Hillsdale Carriage Shop**  
188 Blank Road  
Narvon, PA 17555  
717-768-3514

**JD Carriage**  
265 E Kneeland Rd  
MID MI 48647  
641-715-3900 x 72173

**Jerusalem Carriage**  
3290 E Sherman Hollow Rd  
Penn Yan NY 14527  
315-536-3975

**JR'S Buggy Shop**  
1480 Boyd's Knob Road  
Munfordville, KY 42765  
270-528-4954

**Jonas Gingrich**  
11461 Chariot Rd  
Elton, VA 52141  
402-852-8010

**Keystone Harness**  
1017 Oregon Hollow Road  
Drumore, PA 17518  
717-284-4565

**King's Creation**  
384 Newport Road  
Ronks, PA 17577  
717-656-9782

**Leola Carriage**  
260 S Farmersville Road  
Leola, PA 17540  
717-656-4774

**Leola Coach Shop**  
2707 Creek Hill Road  
Leola, PA 17540  
717-656-0038

**Little Britain Buggy Shop**  
144 Clendenin Road  
Quarryville, PA 17566  
717-529-3120

**LM Woodcraft**  
241 Goodhart Road  
Shippensburg, PA 17257  
717-477-8572

**Maple Grove Coach**  
20440 Path Valley Road  
Dry Run, PA 17220  
717-349-7221

**Maple Lane Carriage**  
2146 N. Ionia Road  
Vermontville, MI 49096  
517-726-0320

**Martin's Buggy Shop**  
24070 CR 46  
Nappanee, IN 46550  
574-831-3699

**Martin's Buggy Repair**  
242 Hoffer Road  
Mt Pleasant Mills, PA 17853

**Mast Buggy Shop**  
W 5253 Barry Road  
Dalton, WI 53926  
608-429-9916

**Meadow View Carriage**  
2891 Vincent Store Road  
Char. C. H. VA 23923

**Mechanicsville Buggy**  
28160 Brisko Anderson Ln  
Mechanicsville MD 20659

**Midshore Carriage**  
W 7770 County Rd H  
Elkhart Lake, WI 53020  
920-894-4995

**Miller Buggy**  
S 2589 Jessop Road  
LaValle, WI 53941

**M&S Coach**  
5624 CR 201  
Millersburg, OH 44654  
330-893-3201

**Mohawk Valley Coach**  
1815 Fordsbush Spur Road  
Fort Plain, NY 13339  
315-823-2053

**Mowersville Coach**  
14551 Paxton Run Road  
Shippensburg, PA 17257  
717-423-6197

**Mullet Buggy**  
10311 ST HWY T  
Powerville MI 64672  
660-341-0315

**Newberry Carriage**  
7040 W 2005  
Topeka IN 46571  
260-768-8055

**Nickel Mine Coach Shop**  
1962 Mine Road  
Paradise, PA 17562  
610-593-1375

**Nisley Buggy**  
41383 Street Hwy 14  
Chariton, IA 50049  
641-774-7543

**Nolt's Carriage Shop**  
750 Mud Level Road  
Shippensburg, PA 17257

**North Country Carriage**  
419 Country Rd 4  
Bambay NY 12914  
518-545-4350

**Northwest Metals**  
16697 West Street Hwy F  
Bethany, MO 64424

**Oak Grove Carriage**  
5690 T.R. 606  
Fredericksburg, OH 44627  
330-695-2119

**Paul J. Hostetler**  
6400 Windsor Road  
Hamptonville, NC 27020  
336-468-8367

**Pecan Hill Buggy**  
27720 Janes Road  
Mechanicsville, MD 20659  
301-290-0539

**Perry County Carriages**  
1425 Blain Road  
Blain, PA 17006  
717-598-6035

**Pine View Carriage**  
6136 S. Cornwell Ave  
Clare, MI 48617  
989-386-4363  
888-857-6340

**Pioneer Equipment**  
16875 Jericho Road  
Dalton, OH 44618  
888-857-6340

**R+D Repair**  
202 N Seip Rd  
Rockville IN 47872  
745-344-5100

**Rieh's Carriage Shop**  
3153 Old Phila Pike  
Bird - In - Hand, PA 17505  
717-768-8938

**Ridge Line Buggy**  
24776 375th St  
Edgewood IA 52042

**Rock Run Carriage**  
8775 W 600 S  
Topeka, IN 46571  
260-593-0362

**Rocky Creek Harness & Carriage**  
8795 Orchard Rd  
Grovesprings, MO 65662  
417-259-2203

**Roys' Harness Shop**  
20560 E 1800th Ave  
Yale, IL 62481  
618-554-6856

**Sand Ridge Carriage Shop**  
528 Dottersers Road  
Mill Hall, PA 17751  
570-726-3941

**Sauder Coach & Restoration**  
N 13367 Fisher Ave  
Thorp, WI 54771  
715-669-3205

**Seasonal Buggy Repair**  
7310 Shabbona Road  
Deford, MI 48729

**Shady Lane Wagons**  
192 Amistown Road  
New Holland, PA 17557  
717-354-8970

**Shiloh Carriage Shop**  
846 S Shiloh Norwalk Road  
Shiloh, OH 44878  
419-896-3869

**Shoal Creek Buggy**  
27010 138th Ave  
Centerville, IA 52544  
641-898-7159

**Shwartz Buggy Supply**  
3663 W 350 S  
Berne, IN 46711  
260-589-2562

**Stoltzfus Coach Works**  
588 Cambridge Road  
Narvon, PA 17555  
717-768-8620

**Stutzman Buggy Shop**  
1652 120th St  
Hazleton, IA 50641  
319-283-8286

**Sunny Acres Carriage Shop**  
2077 Compass Road  
Honey Brook, PA 19344  
717-517-2078

**Sun Valley ENT**  
N 5427 Oak Crest Drive  
Bonduel, WI 54107

**Triple Z**  
N 15 453 Chatlin Avenue  
Dorchester, WI 54425  
715-654-5261

**Troyers Buggy Shop**  
7812 Twp Rd 601  
Fredericksburg OH 44627

**Valley View Coach**  
368 Gun Club Road  
Little Falls, NY 13365  
315-360-7806

**Vernon County Buggy**  
13323 E Indian Line Rd  
Richards MO 64778  
417-321-5087

**Vicksburg Buggy Shop**  
1400 Beaver Run Road  
Mifflinburg, PA 17844  
570-966-3658

**Walton Woodworking**  
6728 West Walton Road  
Blanchard, MI 49310  
989-621-6073

**Wanna Ride Buggy Shop**  
21757 Hwy 63  
Bloomfield, IA 52537  
641-664-3491

**Weaver Carriage Shop**  
361 Iron Bridge Road  
East Earl, PA 17519  
717-445-7944

**Weavertown Coach**  
3007 Old Phila. Pike  
Bird-In-Hand, PA 17505  
717-768-3299

**Windy Acres Carriage Shop**  
274 Peters Road  
New Holland, PA 17557  
717-355-5053

**Windy Knoll Farm and Buggy**  
400 Flok Road,  
Fredonia, PA 16124  
724-475-3945

**Wood Lane Carriage Shop**  
1549 Pulpit Road  
Martinsburg, PA 16662  
84193-0128

**Yoder Blanket Shop**  
261 County Road 19  
Whitesville, NY 14897  
607-356-3535

**Yoder's Buggy**  
2265 Patriot Road  
Patriot, OH 45658  
740-853-0626

**Yoder's Buggy**  
43830 195th Avenue  
Bertha, MN 56437-1315

**Yoder's Buggy Shop**  
10073 Zuehrer Road  
Dundee, OH 44624  
330-359-0019

**Yoder's Buggy Shop**  
1280 Blaylock Store Road  
Mekenzie, TN 38201  
731-352-7739

**Yoder Wagon Works**  
13570 Keller Dr  
ST Charles NW 55972  
507-932-3448

**Yoder's Welding & Repair**  
200 Lake Rd  
Paris Ky 40361  
859-707-6163

**Yoder's Woodworking**  
W 3423 S Hwy 85  
Durand, WI 54736  
615-672-4216

**Zimmerman Carriage Works**  
6569 E. Carson City Road  
Sheridan, MI 48884  
989-584-0753



Have you extended lead times? Turned away work?  
**Save Time, Save Steps & Increase Productivity**  
 by introducing Flextur into your workflow.

**Flextur**  
 Efficiency is within reach.



**Flextur has improved operations for** Fabricators, Manufacturers, Woodworkers, Shipping Departments and others both large and small. Call today. Share your challenges and learn how Flextur products could improve your business.

A Division of Pioneer Corp.  
 16075 Switzer Road • Dublin, Ohio 43019  
[www.flextur.com](http://www.flextur.com) • [flexturusa.com](http://flexturusa.com) • 877-435-3888

PATENT PENDING • MADE IN USA

**PIONEER**  
*Carriage*

# Where is the weight in your buggy?

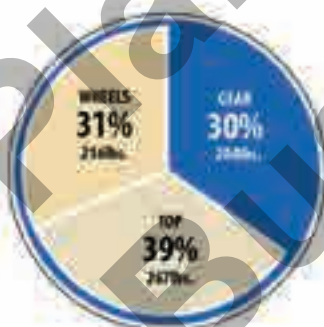

Without Passengers

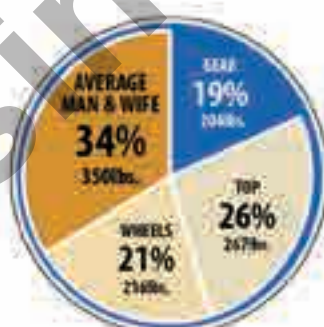

With Just Two Passengers

An Average American Male Weighs 180lbs  
 While an Average American Female Weighs 170lbs

Our gear accounts for less than 1/4 of the total weight of a buggy when carrying an average couple weighing 350lbs. **Less than 6% more than an average gear.** And even less when you add the family. Don't be talked out of the safe, smooth, quiet ride of a genuine Pioneer Carriage gear for so little.



Pioneer Carriage • Dublin, Ohio U.S.A. • 888.857.6340



**WGC**  
**Walnut Grove Canvas, LLC**

Amos & Reuben Troyer  
 8901 S. 184th Ave. • Holton, MI 49425

**Custom Made:** • Ventilation Barn Curtains • Hay Tarps  
 • Cherry Tarps • Building Covers • Truck Tarps • Liners  
**(231) 821-0519 • Fax: (231) 821-0511**  
*"Tarp Solutions for Ag and Industry"*

**REPLACEMENT COVERS FOR ALL BRANDS**

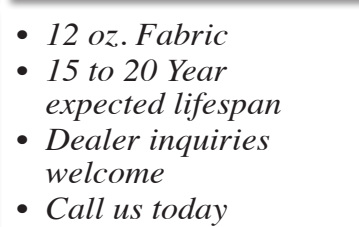

- 12 oz. Fabric
- 15 to 20 Year expected lifespan
- Dealer inquiries welcome
- Call us today



**GREENHOUSE COVERS**

**REINFORCED CORNERS**

**WOODWRIGHT**  
 QUALITY WOOD FINISHING PRODUCTS

**Complete Protection**  
 NO OFFENSIVE BURN OR HEAVY ODORS

**VIRTUALLY ODOR FREE!**

**NO EYE BURN**

**NO NOSE BURN**

**100% Formulation Free CATALYZED VARNISH**

**1.800.322.8172**  
 1225 US Route 62 • Wilmot, OH 44689 • woodwrightfinish.com  
 Manufactured by David E. Easterday & Co., Inc.

**CERTIFIED ORGANIC AND CHEMICAL FREE**  
**Transition Balage**

**South Central Pennsylvania**

- Alfalfa and Alfalfa/Grass Mix individual wrapped Round 4x4.5 and big Squares 3x3x5 tests available \$100.00 each.
  - 3x3x7 Alfalfa/Grass mix and Grass. Dusty, not for horses \$80.00 each.
- Delivery available.  
 Buy direct from us the farmer.  
 We use and sell the Blue Gold Eden Solution fertility programs.

965 W Matterstown Road, Millersburg, PA 17061  
 717-433-7702

**Xcite Repair Co.**

**Kubota**

**Engines • Parts • Power Units**  
 200 Shirktown Road • Narvon, PA 17555  
 484-256-9815 • Fax: 484-206-5556





# COUNTRY SIDE Clocks

36 Parlett Road  
Airville, PA 17302  
717-378-4457

**We prefer you mail in your orders with payment for better service.**

**GET YOUR ORDERS IN EARLY THIS YEAR!**

**REMEMBER THE MAIL WOES LAST DECEMBER!**

**This one runs backwards!**

**"Krazy" Clock**

**SAMPLE ORDER**

Please send me 2 Krazy Clocks.

2 clocks at \$25.00 each =.....\$50.00

Have your Name Printed .....\$5.00

Each additional Print

with same name .....\$1.00

\$56.00

Print in this name.  
(Your Company Name)

The glass pops out easily so that you can write or stamp your company name on the cart. Or if needed, you can photocopy your logo, then cut and paste it in the cart.

The cart is sized to fit the common self inking stampers



We can print your company name on the cart for you even if you only get one for your bosses office. (sorry, no logos) **OR** ... order 25 or more for your favorite employees and vendors, and have us print your logo on the cart for you! (Please call for details)

**GO Krazy!**  
and get **FREE SHIPPING**

PA residents add 6% sales tax.

\$25.00 each — \$21.50 for 25 or more.

Call or write and **mention code PCBE** for our **FREE**, 32 page, full color catalog of wooden wall clocks.

From these



**#B11-09QM — \$199.00**

Battery Operated with 12 Melodies

**#11-09 — \$215.00**

One Day Weight Driven — 9"

**#811-13 — \$359.00**

Eight Day, Weight Driven — 13"

These three Cuckoo Clocks look very much the same.

To these

Scottsville



\$245.00

Battery Operated

**#311-329**

Cherry

**#211-321**

Light Oak

Stepney



**#210-340 — \$559.00**

Windup

**#212-114 — \$369.00**

Battery

To these

#115

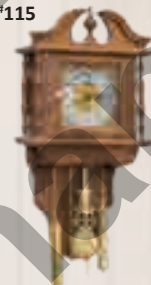

#210



And ask for our catalog to see more!



**WE PRODUCE QUALITY HANDMADE CUSTOM PRODUCTS TO HELP PEOPLE WITH GRID SOLUTIONS. ALL LIGHTS AVAILABLE IN MAKITA, MILWAUKEE, OR DEWALT.**



- ★ Shipping Available
- ★ Call for a Catalog



**NEW** baby monitors & diffusers. Available in Makita, Dewalt, or Milwaukee.

**Dealership Inquiries Accepted**

**10% Off All Lights Thru 12/31/21**

# GEO LIGHTING

Devon & Doris Miller • (260)599-8082 • 12284 CR 34, Goshen, IN 46528  
Afternoon Hours: Mon. Tue. Thurs. 2-5pm | Sat. 8am-12pm (Hours subject to change)

SOME LIGHTS AVAILABLE IN SHIPSHEWANA

Wayne & Karen Miller • (260)768-7501  
3695 N 850 W, Shipshewana, IN 46565  
Afternoon Hours: Mon. Tue. Thurs. 2-5pm | Sat. 8am-12pm



# Sun Lite Herbs AND FABRICS



**WE REPRESENT:**

- 4Life Transfer Factor
- Krause
- Sprigs
- Natural Hope Herbals
- NOW
- Buried Treasure
- And Many More

*Reign Napkins*  
\$6.29 each  
Buy 9 get 1 Free  
Buy 14 get 2 Free  
*Ask us about wholesale opportunities.*

We have products for everyone,  
especially for mothers and children.

*We will be running sales in  
February, May, August & November  
so be sure to get a catalog.*

---

WE WILL SHIP THE SAME DAY WHENEVER POSSIBLE.

**7926 CR 49 • BELLE CENTER, OH 43310**  
**(937) 464-9099**  
Monday-Friday 8AM-5PM • (We speak Dutch)

**CALL FOR A  
FREE CATALOG**

\*Note: Add \$8.95 for shipping and handling. OH residents add 7.25% sales tax.  
Not tested or approved by the FDA, for safety or effectiveness.  
Use only as directed by your care provider.



# Gift Boxes

We Ship



**The Red Shed**  
CHOCOLATES  
GIFTS TOYS & MORE



## Homemade Chocolates

Available in a 15 or 30 count

We were featured in the Dec. '19 PCBE

## Jam, Cheese & Chocolates



## Store Sampler

**641-664-1213**

**21021 JEWEL AVE. • BLOOMFIELD, IA 52537 • Mon.-Sat. 8 to 5:30**



**WACKY'S  
HANDY DANDY LLC**  
260-452-8754  
18690 CHANEY ROAD  
SPENCERVILLE, IN 46788

# Barrel Lamp

## \$240

**Shipping**  
\$15 on Orders under \$300  
\$10 on Orders over \$300  
*Wholesale rates available.*

**Includes:**  
**10W Dimmable bulb,**  
**Shade, and**  
**Battery adapter**  
Also available in AC

**Adapter options**  
**(specify with order)**  
**Milwaukee**  
**Dewalt | Makita**

Dims:  
Barrel - 8.66" x 11.41"  
Lamp Shade - 11.81" x 8.66"



**Dealer Inquiries  
Welcome**



• Powder coated aluminum  
• Custom sizes and styles available



Wall Mount



Stove top

**Distributors**

Sam M Stoltzfus, Gap, PA 717-442-8169  
Mecan Market & Furniture Coloma, WI 715-228-3568  
SBS Country Store Bryant, IN 47326 260-760-5431

**Dealers**

Brownell Foods & Varitey Clymer, NY | 716-397-5388  
Custom Kitchen & Country Lane Shoes Flemingsburg, KY | 606-845-7407  
Creskide Creatives Montgomery, IN | 812-444-9784  
Eicher Variety Store Carlisle, KY | 859-274-5125  
Kuntry Nook Store Topeka, IN | 260-593-0787

Lehmans Variety Store Lagrange, IN | 260-463-7469  
Meadow View Enterprises Greenwich, OH | 419-895-9973  
Miller Maytag & Engine Dorset, OH | 440-293-1223  
Robert Troyer Gonvick, MN | 218-487-5976  
Steven Stoltzfus Springmills, PA | 814-404-2715  
Yoders Footware Utica, MN

**Train View Window and Door**  
**72729 CR 9 • Nappanee, IN 46550**  
**574-773-7640**



**YOUR SOURCE FOR QUALITY PRINTING  
& PROMOTIONAL PRODUCTS  
AT A FAIR PRICE**



**FULL COLOR PRINTING**

Catalogs, Brochures, Flyers, Invoices, Custom Forms, Notepads, Posters, Postcards, Business Cards, Calendars, Envelopes, Vinyl Banners



**GRAPHIC DESIGN**

Catalog Layouts, Ad Designs, Logo Design

**NOTICE:**

Many of our distributors currently have items with extended lead times or back-orders. Order your Christmas promotional giveaways now.



**PROMOTIONAL PRODUCTS**

Pens, Mugs, Flashlights, Calendars, Shirts, Hats



**Main Office** • 330-893-0160

5991 CR 77 • Millersburg OH 44654

**Middlefield Office** • 440-462-8300

15561 W High St • Middlefield OH 44062

Fax. 330.893.2589 • sales@inkscapeprint.com



**PLASTIC CABINETS  
WHOLESALE OR RETAIL**

*Cutting Boards*

Size 8" x 12"

1/4" \$5.00  
1/2" \$8.00

**Wall Letters**

3" \$5  
10" \$19  
18" \$45.50  
24" \$79

**PLASTIC MAILBOXES \$95**



**JAYLOR PLASTIC**  
Jacob & Laura Miller  
7300 N 675 W  
Shipshewana, IN 46565  
Phone: (260) 562-3641  
Fax: (260) 768-7742  
jaylorplastic.16@gmail.com

**House numbers**

24" \$90

**House numbers**

The look and functionality of custom cabinets  
*without* the custom price!

# Kountry

WOOD PRODUCTS

"KITCHEN CABINETS WORTH OWNING"



### DEALERS NATIONWIDE

Call 888-608-8969 to be directed to the best dealer for you.

CONDENSED LIST FOR YOUR CONVENIENCE:

Kountry Cabinets & Home Furnishings - Nappanee, IN | 574-751-9225

Bailey's Discount Center - North Judson, IN | 874-396-3889

Centerline Cabinets, LLC - Apple Creek, OH | 330-601-1212

Miller's Holzwerk - Brazil, IL | 217-578-3498

Wolf Home Products - PA | 800-244-9653 Select Option 2

KOUNTRY WOOD PRODUCTS  
352 SHAWNEE ST. NAPPANEE, IN 46550

## TIMBER KING

A New Game for the Whole Family!

\$45.00 each postpaid

3+ \$42.00 each postpaid

OH Residents add 6.75% Sales Tax

Timber King reinforces math and business skills through buying & selling timber. Can you manage your money good enough that you don't have to borrow money? Play Timber King and find out!



## THE WHIMSY WASHER GAME

Fun for all ages!



\$25.00 each postpaid

3+ \$22.00 each postpaid

OH Residents add 6.75% Sales Tax

2 to 6 players • Each player has 10 washers to start. The object of the game is to be the first player to get rid of all of their washers. Roll the dice and put the washer in that number slot on the game. You may roll the dice as many times as you wish. If you roll a 6, you may roll again if you want to risk it. If you roll and it matches a washer already in that slot, you must remove and keep all the washers on the box and send it on to the next player on your left. The first player to get rid of all their washers is the winner for that round. Keeping score, each washer is a point against you. You may play as many rounds as you wish. Lowest score is the winner. Game includes a dice and 60 washers, all stored inside the game.

### Complete Line of Harmonicas From the World's Best Brands

#### SEYDEL

Concerto Steel  
Club Harmonica  
Blues Session Steel  
Tremolo Sailor Steel  
Concerto Star

#### Big River

Bluesband  
Golden Melody  
Hot Metal Harp  
Marine Band  
Old Standby Harp  
Special 20  
Echo  
Echo Celeste

#### #8362 Echo

Double Sided Echo  
32 Hole  
Double Sided Echo  
48 Hole  
Weekender Tremolo  
16 Hole  
Weekender Tremolo  
24 Hole  
Comet

#### SUZUKI

Easy Rider  
Folkmaster  
Harpmaster  
Bluesmaster  
Overdrive  
Promaster  
Promaster Valved  
Pipe Humming  
Tremolo 2 Timer

## SUNSET SALES

WHOLESALE INQUIRIES WELCOME

15316 HAYES ROAD  
MIDDLEFIELD, OHIO 44062  
FREE CATALOGS AVAILABLE

We specialize in complex equipment

# SLAB MUNCHER

### Options Available:

- Engine Mounting
- Conveyors for infeed  
6', 7', 8', 10', 12', 14', 16',  
lengths
- Right or left  
side drives

**\$16,600<sup>00</sup>**

for standard 16" model

### Available Sizes:

12" model

16" model

20" model

24" model

TURN YOUR  
**SAWMILL WASTE**  
INTO GOOD ABSORBABLE  
BEDDING

For more information write:

*Valley Machine & Fab*

10975 State Route 26, Ava, NY 13303





Manufacturer and  
Distributor of  
Top Quality Harness &  
Harness Parts

Made with **BIOTHANE**

**Wholesale Only**  
**N&A**  
**Harness**  
**Shop LLC**

Contact us to locate your nearest Dealer, or to make a Dealer inquiry  
6009 TR 419 • Millersburg, OH 44654 | Phone: 330-893-1024 • Fax: 330-893-0112

# Discount Shipping Labels by Fax

Are you overpaying for postage? Till now to get the best shipping rates you had to have a computer to print labels, and send a huge volume of packages. Now you can get the same great rates that high volume shippers get. All you need is a fax machine. We give up-front pricing, no monthly fees, service fees, or anything above the quoted label price. During business hours we send labels within an hour. Want to compare with what you are currently paying? We offer free rate quotes.



**M Tech**  
1573 State Rte 5 and 20  
Geneva NY 14456  
Phone 315-828-7799  
Fax 585-526-2100

	Post Office Rate	Mtech Rate
5 lb. from 14456 to 17601 Priority	\$10.95	\$7.29
Medium Flat Rate 14456 to 17601	\$13.65	\$12.95
25 lb from 14456 17601 Priority	\$27.85	\$21.95

**IbyFax**



# Heartland Fabrics, LLC

## Wholesale Distributors of Quality Fabrics, Leather & Suedes

- Over 400 In-Stock Fabrics
- Genuine Full Hide Leathers
- Faux Leathers
- Micro Suedes  
(Water Resistant)
- Crypton® Home Fabric  
Easy Clean – Durable – Odor Resistant
- Revolution  
Performance Fabric  
Stain Resistant
- Full Rolls / Cut Yardage

***Servicing furniture builders, upholstery shops, & buggy shops***



**heartland-fabrics.com**



Conveniently located in Northern Indiana, call or write for more information. (Fax orders if possible.) Please include your business name and address.  
5355W 400S • Topeka, IN 46571 • VM: (574) 642-1223 • Fax: (260) 593-4802





**Indoor and Outdoor Performance Fabric - Stain Resistant**





# BUILDING A LEGACY

*A family's journey to maintain their legacy in a changing world.*

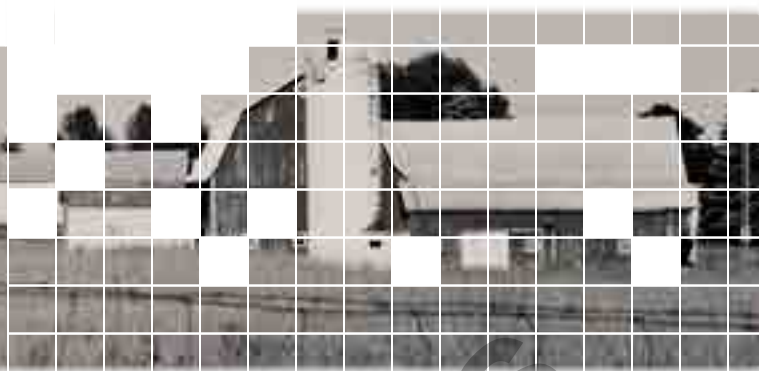

## ***A Glance at Last Month:***

*Last month Simeon visited with Solomon, a former dairyman who had successfully transitioned his family business to a construction company where he and each of his sons could do what they most enjoyed. They discussed how a facilitator had helped Solomon's family talk about their individual interests and long-term goals, allowing them to develop a new business that everyone is excited to be a part of, and that Simeon saw as a similar process for his family to go through.*

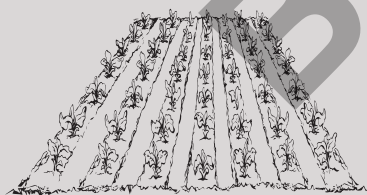

DON TYLER

## **Meeting the Facilitator**

It had been three weeks since Simeon met with Solomon to hear how his family made the transition from a dairy operation, where some of the family members had been unhappy, to a successful construction company where everyone in the family had a unique and valuable enterprise. Hearing Solomon's story had helped Simeon to realize that with the help of a facilitator, his family might have a future that kept his vision of a farming legacy intact for another generation. Now that it was early December, all the major activities for the produce farm had been completed for the year and it was easier for Simeon to focus on other things. He had contacted the facilitator that Solomon's family had used, and their introductory meeting was scheduled for next week.

Simeon was both excited and anxious about meeting the facilitator. On the one hand, he wanted to hear what the facilitator could do for them. On the other hand, Simeon was a private person, and he wasn't sure he could share all the personal information that the facilitator would probably ask about. He had decided that for now he was only going to share the details of the conversation with Dorothy, and not mention it to the older children. She liked what she had heard about Solomon's family and kept asking about their process. She had more questions

about their family's transition than Simeon had thought to ask, and he was getting a little frustrated with her constant need for details. "Since it sounds like this process might really help our family, don't you want to have that meeting with the facilitator right away?" Dorothy had asked. "And would you mind if I went along?" Simeon could tell by her look that she thought he wouldn't ask all the questions she would. He had subtly suggested that since neither of them wanted to tell the rest of the family about working with a facilitator yet, they shouldn't go to a meeting together as that would definitely raise questions. This seemed a good enough reason for Dorothy, but it didn't stop her from hinting about questions Simeon "might want to ask the facilitator..."

In the last few weeks, Ida Mae had grown more and more excited about her work at the gift shop. The Christmas shopping season was in full swing, and she got to talk to new people all day, helping them make the perfect gift selections for family and friends. The people that owned the shop grew more delighted with her every day and let her know how much they appreciated her enthusiasm for her work. Their regular customers commented on Ida Mae's unique ability to help them select the



most appropriate gift, regardless of the person they were buying for. With just a few questions about the recipient, she could point them to options that made their choice easy and satisfying. Many of them asked her for ideas for people on their list that were the hardest to buy for, even if they wouldn't find those gifts in her store. It was clear to the owners of the store that Ida Mae loved helping people, and she had a unique ability that was increasing their sales and customer base. They were making big plans for her.

Calvin and Daniel were gaining valuable experience as well in their off-season jobs. Calvin was spending more time with men his age who were struggling to find their place in the family business. The excellent work that Daniel had recently done with the neighbors had prompted them to recommend him to others with small construction projects. All these different work experiences allowed him to build a wide range of skills, and seemed very fulfilling to him. He was getting to know a lot of new people.

When Calvin wasn't helping neighbors with their projects, working with livestock, or doing odd jobs, he kept working at the family's dairy doing his regular duties. While he was getting settled into a regular winter routine, his wife, Irene, was asking questions about their future. She kept asking him, "Now that things have slowed down in the produce business for the winter, wouldn't this be a good time to talk to your dad about where the family business is headed? During the summer you were talking to your dad on a regular basis about things that you think he should consider changing, but now you don't seem to talk about it anymore." Calvin would listen, nod his head, and go back to reading. It wasn't that Calvin disagreed with Irene's suggestion, he just didn't want to talk about it right now, nor did he have an answer that he thought would satisfy her curiosity. Irene was asking questions like this on a more regular basis. Even he could tell that she was getting frustrated with him.

As the time neared for Simeon's meeting with the facilitator, Dorothy grew more and more concerned. Would Simeon tell the facilitator enough to really help them? Would Simeon avoid talking about certain things, or not think they were important, and the facilitator not completely understand their problems? Finally, two days before the meeting, she brought up her concerns. It was late in the evening, when she and Simeon could talk privately without the children hearing their conversation. "Simeon," Dorothy said, "I don't think you are ready for

this conversation with the facilitator. I haven't heard you say much about the specific things you plan to tell him, and I'm worried that important information will be left out. He can't help us if you aren't open with him about our situation." Simeon had heard this tone from her before and was sure he couldn't avoid answering her questions. Before he could reassure her, she gave him some of the details she wanted revealed in the meeting. "You have to tell him about the things the older children have been doing lately. Ida Mae is doing very well at the gift shop, and she's much happier than when she was working on the farm. Daniel keeps getting more requests to help neighbors and he's even helping some local construction companies with small projects. Soon a construction company might offer him a job he loves with better pay than we can afford. You know how hard it is to find good help, and we may lose some of ours!"

Dorothy caught her breath but didn't give Simeon a chance to respond. "And then there's Calvin and Irene. She's been less talkative the last two weeks and I'm wondering what she and Calvin have been talking about. Their baby is expected to arrive in March, just when you need a lot of help planting early produce. Think back to when Calvin was born. He was our first child, and do you remember what those first two or three months were like? Neither one of us was getting much sleep, and it was a busy time of the year for you and your dad. It was all you could do to keep the cows milked, fed, and healthy. Having a baby changes how a couple prioritizes their life, and I'm sure that Calvin is going to want to help Irene with the baby as much as he can. And did you ever talk to Calvin about the time this summer that you were short with him when he was talking about his ideas? He was just trying to make you consider different ways to do things, and all you could talk about was all the work that needed to be done that day. Did you apologize to him about that or not? Don't you think the facilitator is going to want to know all this information?"

Simeon realized she was making some good suggestions, and no, he hadn't considered most of the things she was worried about. After what seemed like several minutes but was only a fraction of that time, Simeon said, "You've made some very good points that I hadn't thought to mention. You're right. The facilitator is going to want to know about these situations and probably a lot more. Thanks for putting so much thought into this, and for sharing it with me before the meeting. How about we sit down together at the kitchen

*Building A Legacy - Continued on Page 112*



**Simeon's Lesson of the month:**  
*"In times of uncertainty, building an initial strategy helps create peace, comfort and confidence."*

*Building A Legacy - Continued from Page 111*

table, and I'll write down all the things you want brought up during the meeting. Would that give you more peace about this?" Dorothy appreciated her husband's thoughtfulness and finished her final tasks of the evening as he found a pad of paper to take some notes.

Simeon and the facilitator met at the appointed time, and the facilitator listened patiently as Simeon began to share their background and the situation with the business. The facilitator could sense it was difficult for him to share with someone he had just met, so he gave Simeon plenty of time to think through the details of his concerns and challenges. Simeon appreciated the facilitator's patience and sincere interest in his situation, and the concerns for his family's legacy.

As they talked, the facilitator could see that Simeon had a very detailed list of things to share. "That's a pretty impressive list you have there. Most people don't put that much thought into what they want to talk about in a first meeting. You've done your homework."

"Well," Simeon confessed, "it was really my wife that wanted to be sure I mentioned all these things. I'm not normally this prepared, but we had a conversation about what to share in this meeting, and it was clear that I needed a list."

"That's good of your wife to help you make that list," the facilitator said with a smile. "I look forward to meeting her, hearing of her personal concerns about this process, and what she feels is most important for the family's future."

The facilitator had several questions, just like Solomon had said he would. As he talked to Simeon about the process

of building a comprehensive succession plan that would fit the family's needs, he stressed the importance of him understanding the family's values to make certain that his advice was aligned with their priorities and long-term goals. There would be many things to consider, and decisions to be made, to build a plan that fit their family. If they weren't working toward the same goals, they wouldn't develop the amount of trust needed to have total confidence in the process—or in the results.

It gave Simeon a sense of peace hearing that the facilitator had worked with many different types of family businesses, most of them entrepreneurs who had to take measured risks to achieve their goals. He was also very interested in each one of Simeon's family members, from him and Dorothy to each one of the children, and what their personal interests were. The facilitator seemed to be most interested in the oldest children who were developing interests of their own off the dairy, and how much they liked those activities. After hearing what Simeon had said, he had several questions about Calvin, what he thought of the dairy, and what he had said about the future of that business.

The facilitator outlined the strategy he would use to help them develop their succession plan. The first meeting would include all the people directly affected by the decisions that were made and who would provide valuable input. For Simeon's family, that would include Simeon, Dorothy, Calvin, Daniel, and Ida Mae. The two younger children wouldn't have much input or be directly affected for some time, so they would not be included until later in the process. They discussed whether or not to include Irene. The facilitator said that in cases where there are several daughters-in-law or sons-in-law in a family, it needs to be decided which ones are directly involved in the business on a regular basis, and who knows enough about the business to have valuable



input. Since Irene was the only in-law in the family right now and was regularly there to help with the business as needed, they agreed she should be included in all the discussions.

The facilitator went into additional details. “The first meeting will focus on allowing the family members and me to get to know each other. I’ll hear from each person individually, ask them questions about their role in the business, and outline the process of getting from where you all are in your current business to where you want to be in the future. We will also do a fun exercise using a behavioral assessment tool that I like to use in these situations. The things we learn will help us communicate more effectively in our meetings, understand why you approach tasks differently, and why you prioritize some activities over others. To make sure we stay on track and make our conversations as productive as possible, I’ll have an assignment for each of you to do to be prepared for the next meeting’s discussion. Does that sound alright to you, Simeon?” Simeon nodded with cautious approval.

The facilitator continued. “From there, we will discuss your strengths as a family and as individuals, what each of you likes to do with your personal time, how the businesses are doing now, your ideas on how to make the current businesses more productive and profitable, and the alternative businesses that you have considered. We will also discuss your vision as a family and what it would take to achieve that vision. With all this information, we will build your comprehensive succession plan.”

“I know that sounds like a lot of work, and it is,” the facilitator admitted. “Altogether, the process will take about a year. Each meeting creates another list of questions that each one of you must consider and answer from your own personal perspectives. We have to consider all these different ideas to be sure that everyone can be completely comfortable with the plan we develop.”

As the discussion finished, the facilitator said, “Even though this is a difficult process that will take some time, it is not

hopeless and it’s not something you need to dread. Some parts will be fun, some tough, and a few will probably be uncomfortable, but I am confident we can work through this. I am here to help all of you work together—to make sure that we stay on track and that the essential questions are asked—and you and your family are going to decide what is most important to you and where you want to go. Working together, we can get through these discussions and make a plan that meets the needs of your family now and for future generations.”

They agreed to have their first meeting with the entire family after the holidays.

On his ride home, Simeon couldn’t believe how comfortable he was with the process. Despite knowing parts would be difficult and having no idea where this was going to go, he now felt a sense of peace about how they would move forward, and confidence that his family could indeed work together successfully.

#### **To be continued next month....**

*Don Tyler is Founder of Tyler & Associates Executive and Management Coaching. Don grew up on a family farm, managed businesses for 16 years and has been a private coach for the last 26 years with clients across the country in all types of businesses. Most of his clients are multi-generational family businesses that have had to make difficult choices as they navigate the process of transitioning the business to the next generation. For help with succession planning or any other management issue, he can be reached at 765-490-0353, through e-mail at don@dontyler.com, or his website at www.dontyler.com*

Image credits:  
Page 110—Header, Camary Miller Photography/Shutterstock.com;  
Sidebar top, bioraven/Shutterstock.com;  
Sidebar bottom, ArtMari/Shutterstock.com;  
Page 112— aksol/Shutterstock.com

**WE CAN PRINT IT!**

## Quality Work at Reasonable Rates!

- Custom Graphic Design
- Signs & Banners
- Brochures
- Business Cards
- Envelopes
- Programs
- Flyers
- Menus
- Posters
- Forms
- Catalogs
- Direct Mail Marketing

[www.truaxprinting.com](http://www.truaxprinting.com)

**TRUAX PRINTING**  
QUALITY IMPRESSIONS SINCE 1966  
419-994-4166 info@truaxprinting.com

# INTOLERANCE TEST

## Food Sensitivity Test

Just mail in a hair sample, contact information, date of birth and \$100 payment to: Many Words Herbs, 1176 US RT 302, East Barre, VT 05649  
You'll receive your test results with in 10-20 business days.

Food intolerances can also lead to chronic diseases by creating inflammation within the body. It's a well-known fact that all disease starts with Inflammation. It's like putting watered-down gas in your Honda engine. We all know what happens when you do that!

Imagine what years of inflammatory foods can do to your body over time? We'll do a simple DNA test that recognizes what 600+ different foods/non-food products are causing your body the most harm.

We'll also test you for the 80+ essential minerals, vitamins and nutrients. This portion of the test is a good balance to creating a healthy lifestyle and can boost the immune system and reduce your intolerance levels simply by adding recommended foods to your diet.

*Many Words Herbs*

*Therapeutic Practice & Apothecary*

**Rosalene Bussiere**

*Certified Therapeutic Herbalist, SRT Neck Release (AtlasProflix),  
NADA Cert., DNA Technician*

802-793-9371 • manywordsherbs1.weebly.com



**Masthof**  
PRESS & BOOKSTORE



Biographies, Novels, Religious, Genealogy, Local History, Amish, PA Dutch, Mennonite, Anabaptist, Children/Youth Books & more!

Call today for your **FREE** Catalog!

**610-286-0258**

orders@masthof.com  
219 Mill Road, Morgantown, PA 19543

www.masthof.com

Contact us for  
**WHOLESALE** pricing!

**50% OFF  
A CASE!**

*\*Any one Masthof  
Press title per case.*

## Created to Be His Helpmeet

by Debi Pearl

Somewhere over the passing years and changing culture, women have lost their way. This book is written to lead them back home. Regardless of how you began your marriage or how dark and lonely the path that has brought you to where you are now, I want you to know that it is possible today to have a marriage so good and so fulfilling that it can only be explained as a miracle.



Use Coupon Code

**PCBE21**

Expires 11/30/2021

Specify English or German

Regular \$16.95

Discount -\$6.00

**SALE \$10.95**

Shipping Charge \$ 5.95

**Total \$16.90**

Plus tax for TN, OH, DE, IL, KS

Also available in  
German!

No Greater Joy Ministries  
1000 Pearl Rd  
Pleasantville, TN 37033

www.nogreaterjoy.org  
1-866-292-9936  
Open Mon - Fri 8:00-5:00 (CT)

The innovative post driver.



Attachments that make your jobs easier...



- Post Driver • Montana Breaker
- Montana T-Rex • Tilt Attachment

Innovative attachments  
that are faster, more  
reliable and safer.

*Various model sizes for skid steer or  
excavator mount.*

TILT ATTACHMENT

T-REX DRIVER

Montana Post Driver East LLC | phone: 574-831-3078 | [montanapostdriver.com](http://montanapostdriver.com)





# Charge Pro Lithium

Will charge all batteries-Lithium, lead Acid, Gel, Etc.

Rechargeable "D-Size"  
Battery Powered Products  
**Charge Pro "D-Cell"**



**Best  
seller**



**Item# 146CPLBH**

- 14.6 volt
  - Adjustable Amps
  - 45 Amp max
  - Belt Drive
- Honda Powered!  
Lithium ready!  
Better charge!  
**\$675.00**

- 14.6 volt
  - Adjustable Amps
  - 45 Amp max
  - Lithium Ready
- Power these units with  
your existing power  
source -  
Line shaft, etc.  
**\$295.00**



- "D-Size" 32650 6000mAh 3.2 Volt Battery- Premium Grade A LiFePO4 Lithium Technology
- Must be used with low voltage shut-off
- Recharge thousands of times!

Battery Prices: \$9.95 each  
24 or more @ \$8.95 each



**8D Battery Case  
w/ Pigtail 13.6 volt  
output  
Item # 8DC \$70.00**



**Item #368D  
Charger \$65.00**

**Christmas Special free shipping  
on all products if check received  
with order and ad:  
Ohio residents add 6.25% sales tax**

**Batteries  
not included**

Buy any 3 or more items plus  
24 or more batteries and get 5% off !



**Diffuser Item # DIF  
\$145.00  
8 hour run time  
on High  
Diffuser NOT  
Included!**



**Lamp - Item # 8DL \$95.00  
15 hours runtime with 10 watt bulb  
Available in Oak Wood and in  
3 poly colors:  
Teal, Brown, or Burgundy**

## Ohio Valley Engine Repair

281 Grate Road, Patriot, Ohio 45658

## Bible Stories...

Teaching your child  
to share Biblical values...



### The Bible Story Set...

By Arthur S. Maxwell  
Easy to read and understand,  
The Bible Story Set is every  
tellable story from  
Genesis to Revelations.

**10% OFF  
Christmas  
Sale and  
Free  
(Media Mail)  
Shipping  
until 12/31/21**

**10%  
OFF  
until 12/31/21**

### My Bible Friends...

Written especially for children  
ages 1 to 8, the beautiful, yet  
simple language makes these  
books a pleasure to read.



### Uncle Arthur's Bedtime Stories...

Help your children  
learn truth, honor,  
respect, integrity,  
& faith in God.

### ORDER FORM...

	Reg price	Sale price	
The Bible Story (set of 10)	\$188.35	169.61	x
The Bedtime Story (set of 5)	\$108.95	98.05	x
My Bible Friends (set of 5)	\$99.25	89.32	x
			subtotal
Pa residents only, add 6% sales tax			
2-5 day Priority Mail or UPS add \$7.00 per set (optional)			
USPS Media Mail 5-30 day delivery			
Phone #			Free
Name:			Total
Address:			
City:	State:	Zip:	

Send to Reuben Lantz - 794 Musser School Rd, Gordonville PA 17529 - 717-875-6140



# GIVE THE GIFT OF FRESH ROASTED COFFEE

We bring you some of the 'best, freshest' coffee direct from the roaster at **Appalachian Mountain Coffee**.



Inviting Aroma - Vibrant Flavors ...  
It's coffee satisfaction

## Coffee Options:

Sunrise Blend, Colombian (regular, decaf, organic)  
\$8.25 per 1/2lb

Kenya, Exotic Blend, Sumatra French Roast  
\$8.75 per 1/2lb.

Try some for yourself- Discover the pleasure of genuinely fresh coffees

K-cups are available in Sunrise Blend, Colombian, Kenya



Mix em' up. Any quantity.  
Box of: 25.....\$18.00  
50.....\$36.00  
100.....\$67.00  
450.....\$270.00

## Tea

\$7.50 pack of 12 Sachets  
\$10.00 per 2oz of loose leaf

Earl Grey,  
New York Breakfast,  
Jasmine Green,  
Jasmine Citrus,  
Moroccan Mint  
Sage Lavender White,  
Savannah Sunrise,  
Summer Sunset  
(Caffeine Free)



The out-back, off-grid coffee roaster



Use Code 'coffee10' for 10% off 1st order. Excludes K-cups



All orders are Shipped Fresh. Every order is shipped directly from the Roaster to you.  
Shipping: \$5.00 on orders of \$35+ • Free shipping on \$72+ • Satisfaction Guaranteed.

**Cirrusly Fresh Coffee** • Phone: 570.239.3625  
sales@cirruslyfreshcoffee.com • www.cirruslyfreshcoffee.com  
9361 Rt 104, Mount Pleasant Mills, PA 17853



SPECIALTY PAINTS & COATINGS, INC.

We Have You COVERED!



## Specializing in Wood and Metal Coatings



PPG TrueFinish®  
Industrial Coatings



## SPRAY BOOTHS

Designed for the biggest or smallest job

### • Full Line Supplier of Graco Spray Equipment

Conventional, HVLP, Airless & Airless Air Assist Spray Guns.

### • Pneumatic Piston Pumps

### • Diaphragm Pumps

### • New & Used

### Finish Equipment

### • Parts and Service on Most Brands

## FOR YOUR EXTERIOR NEEDS



ProLux®

### Prestige. Performance. Perfection.

When it comes to professional coating products, the PPG ProLux name is known for exceptional quality. Our mission has been to provide high quality products that protect and enhance the natural beauty of wood. PPG ProLux products deliver a transparent furniture-like finish that complements the appearance of your home.

Wide Belts • Sanding Discs (PSA & Velcro) • Sanding Sponges & Blocks  
Stain Rags & Sponges • Nitrite Gloves • Spray Booth Filters & Floor Paper  
3M Respirators • Touchup Markers • Fill Sticks and Aerosols

Sales Representatives: **Max Crider, Ron Effland, Brad Diller**  
phone: 717-249-5523 • fax: 717-249-5445  
608 Alexander Spring Road, Carlisle, PA 17015





# EASY ROLL SHADES | SOLAR . BLACKOUT . LIGHT FILTERING

MORE THAN YOUR ORDINARY SHADE • Custom Made Simple • Manual or Motorization



9098 State Route 39 | Millersburg, OH 44654  
p. 330.674.2590 f. 330.674.2560  
[www.creativeholmes.com](http://www.creativeholmes.com)

**CALL TODAY**

- OR -

**VISIT YOUR LOCAL DEALER.**

## AUTHORIZED DEALERS

**HERITAGE FLOORS**  
60 N Ronks Road | Ronks, PA 17572  
717.687.7906

**SUNLIGHT ENTERPRISE**  
65365 E Countyline Road | Millersburg, IN 46543  
574.612.4313

**THE BARGAIN BARN**  
N15790 Bruce Mound Avenue | Thorp, WI 54771  
715.669.3951

**LIVING VALUES HOMESTORE**  
3607 SR14A | Penn Yan, NY 14527  
315.536.3900

**WEST BENCH COUNTRY STORE**  
749 W Bench Road | Roberts, MT 59070  
406.445.2197

**MOUNTAIN VIEW RE-UZ-IT**  
313 Rakers Mill Road | Elizabethtown, PA 17023  
717.602.9984

**GREENIE MOUNTAIN LLC**  
6998 CR FF | Lajara, CO 81140  
719.974.9103

**RIVERSIDE GLASS**  
7376 Road 136 | Newton, ON N0K1R0  
519.595.8683

# TYPEWRITER SALES

**NEW**



Nakajima WPT160



Canon TypeStar 4



Canon StarWriter 300 JET



DP-525CJ Brother

## REFURBISHED TYPEWRITERS

- Brother 530
- Brother 525
- StarWriter JET 300
- StarWriter 30
- Canon TypeStar 220
- Canon TypeStar 110
- Canon TypeStar 10 II
- Canon TypeStar 2, 3, 4, 5, 6, 7

## NEW TYPEWRITERS

- Nakajima 150, 160
- (1 year warranty)

**WE ALSO SERVICE AND REPAIR TYPEWRITERS**

**WE ARE INTERESTED IN BUYING BROTHER DP-CJ SERIES TYPEWRITERS OR PARTS**

## ACCESSORIES

- Ribbons
- Ink
- Thermal Paper 100 Sheets
- Thumb Drives installed *(optional)*
- Buggy Buddy Power Source
- 12v Clamps For Power



# Makes a Great Christmas Gift

**NEW** LED Desk Lamp

Are you straining your eyes to see while sewing or reading?  
Do you need extra light in shadowy hard-to-reach areas?

Use our LED lamp with its flexible neck and movable head to direct light wherever you need it. Just set it on your desk, sewing machine or table. Powered with the cordless battery of your choice.

5amp battery run time - 10.6 hrs. Battery not included.  
DeWalt Flexvolt will not fit on standard DeWalt desk lamp.

Millwolt or Makita Desk Lamp

**\$79<sup>00</sup>**  
Plus Shipping

Spend \$75.00 or more to have your name entered into a drawing for a LED Desk Lamp.

Offer Expires: 12/31/21

## CONTACT

John Mark Beiler — 435 Miller Road, Millersburg, PA 17061

**717-403-6272**

Please contact us for a FREE catalog or other ribbon and ink needs

# WANTED Framers in Dayton and Surrounding area

**Are you are looking to start a framing crew or have a business and want steady year round work with easy scheduling**

**Building New Homes Prefab Walls  
Average one week per house with 5 man crew**

**Also looking for trim crews and siding crews**

## Benefits

- Stress free scheduling
- Pay within one week of house completion
- Liability insurance can be provided

call 330-749-6772





**DEALERS:**

**Heritage Haven, IA**  
Chariton, IA | 641.862.3772

**Marvin Hershberger, IA**  
Hazleton, IA | 319.238.0315

**J&S Variety, IN**  
Vevay, IN | 812.571.2192

**Shipshe Farm Supply, IN**  
Shipshevana, IN | 260.768.7271

**Bluegrass Backyard Creations, KY**  
Oak Grove, KY | 270.881.4207

**Fairview General Store, KY**  
Campbellsville, KY | 270.789.0802

**Sinking Creek Lumber, KY**  
Irvington, KY | 270.547.2900

**Leatus Pullus Farm, MI**  
Perry, MI | 517.755.8570

**Kropfs Feed, MO**  
Buffalo, MO | 417.733.2501

**Trimline Barns, MO**  
Sarcoixie, MO | 417.246.5666

**Gray Family Farm, NY**  
New Windsor, NY | 845.534.7143

**Heritage Structures, NY**  
Medina, NY | 585.318.4385

**J&B Enterprise, MI**  
Mio, MI | 989.826.8024

**David Keim, OH**  
3371 Zoar Church Rd  
Jackson, OH 45640

**Pine Craft Storage Barns, OH**  
Middlefield, OH | 440.632.0174

**United Fencing, OH**  
Applecreek, OH | 330.857.1543

**Valley Farm Supply, OH**  
Sugarcreek, OH | 330.852.4750

**Millwood Woodworking, PA**  
Gap, PA | 717.442.8583

**Mountain View Farm Products, PA**  
Somerset, PA | 814.483.2389

**Pine View Farm Supply, PA**  
Ulysses, PA | 716.550.0862

**E.N.K. Poultry Solutions, WI**  
56418 Spring Valley Road  
Loganville, WI 53943

# PORTA-COOP.COM

**FEATURES**

- ~ TALL DOORS = No More Head Bumping
- ~ Flat Free Wheels = No Flats Ever
- ~ Easy Assembly
- ~ UV Resistant Heavy Duty BLOCKOUT Tarp

**330-600-5722**

[www.porta-coop.com](http://www.porta-coop.com)

Manufactured and sold by Pine View Sales L.L.C. A small family owned business in Ohio.  
**2820 TOWNSHIP ROAD 7 | BRINKHAVEN, OH 43006**

Makes  
A Great  
Christmas Gift



## THE Tator Turbo

Will chop up whatever you put inside.  
It's great for large gatherings.

- Mashed Potatoes
- Pepper Cabbage
- Relishes

or whatever else  
you put inside.

**Makes Mashed  
Potatoes or Coleslaw  
in 30 Seconds**

**\$469.00**

Just wanted to tell you that the Tator Turbo is an awesome chopper! I get our coleslaw chopped in 5 to 10 minutes. Thank you for your great product! I'm really happy with it!  
— Emma J. Yoder

## Stainless Steel Construction



Window in lid allows full view of food processing

Rubber seal prevents spills

Stainless steel latches and handles

Curved blades allow less resistance and more slicing

## How it Works

1. Make sure blade is seated correctly. The shaft must be seated on the nubbin on the bottom of the kettle.
2. Add contents.
3. Attach drill to shaft on top. Must be a newer model cordless drill such as DeWalt 20V or Milwaukee M18. If using an air drill, it must be one horsepower, 1,800 RPM to 2,500 RPM 1/2" shank. The more RPM the better.
4. Turn on your drill for 20 to 30 seconds, and you should have coleslaw or mashed potatoes ready to eat!



**For more information contact Mark Esh 717-460-5787**



# REPLACING YOUR SCREEN DOOR EVERY SEASON! Finally, A Screen Door That Won't Fall Apart!

Screen Doors Built To Last More Than A Season!



**ALUMINUM FRAME**  
TESTED TO  
HOLD OVER 800LBS!

- ✓ **HEAVY ALUMINUM FRAME**  
Will not rot, rust, twist or splinter
- ✓ **SELF LOCKING SCREEN SYSTEM™**  
The screen stays tight and won't blow out
- ✓ **FULL LENGTH PIANO HINGE**  
Eliminates door sag
- ✓ **POWDER COATED FINISH**  
You won't ever need to paint or stain



**SCREEN SYSTEM**  
TESTED TO  
HOLD 550LBS!

**PURCHASE AND INSTALL ONE TODAY!**  
**CALL FOR A DEALER NEAR YOU!**  
*NEW DEALER OPPORTUNITIES AVAILABLE!*



**800-567-8897**  
[www.pcaproducts.com](http://www.pcaproducts.com)



12V DC Tool Battery Charger

**Conveniently charge**  
your batteries on the job.

for Milwaukee or  
DeWalt batteries



**RHINO VOLTZ**

**\$95.00**

Retail Price

Our super efficient charger is perfect for charging your tool batteries on the job. A 50 AMP Anderson connector or battery clamps are available with the charger. It also has a USB port for charging phones and head lamps.

**No inverter needed • Charges 3 AMP per port**

Call 1-800-315-2296 for your closest dealer, pricing, or brochures.





**Problem:** I live in poor cell reception area. My device only works sometimes or not at all.  
**Solution:** Install a Weboost signal booster or antenna. Works for Black Boxes, Cellphones and hotspots!

**Weboost signal booster and antenna, for Cellphones, Black Boxes and Hotspots.**

- Connects wirelessly to cellular device
- 30' outdoor cable.
- Covers a large indoor area.
- Does 3G & 4G service.



**\$399<sup>99</sup>**

**Weboost antenna Black Boxes.**

- Magnetic base mount
- 10' cord
- 12" antenna
- Screws directly into Black Box



**\$44<sup>77</sup>**

**Phone Ringers**

**Clarity**.....\$50.10



- 95 decibel indoor phone ringer
- Adjustable tone
- Powered by phone line/ no batteries or electric needed

**Wheelock**.....\$166.28



- 105 decibel weatherproof phone ringer
- Powered by phone line/ no batteries or electric needed
- Works great for noisy shops and warehouses

**Phone Ringer**

**Wireless Phone Ringer**.....\$69.23



- Wireless range up to 1000'
- Powered by 3 C batteries
- 18 different tones/melodies



**SPEAKER PHONE WITH LARGE TILT DISPLAY**



Price is **\$41<sup>33</sup>**

- Extra large tilt display
- Speaker phone
- 25 name / number phone
- 10 number speed dial
- Caller ID / call waiting
- 65 name / number caller ID history

**PORTABLE PHONE UNIT FOR BLACK BOX**



#1 Gigaset



#2 Gigaset



Complete unit fits into Phone Bag including black box and cordless phone.

- Black semi hard briefcase style carry case phone of your choice, #1 Gigaset, #2 Gigaset
- 10 AH Miller Tech lithium battery that powers all the components
- Black Box not included
- Charging circuit
- 4 ft. 12V charging cord
- 12VDC to 110 VAC adapter so you can charge with whichever option that is available at any time

**203 LUBOLDS SCHOOL ROAD, LYKENS, PENNSYLVANIA 17048 • 717.525.3408**

**Let Us Be Your Internet connection**

For all your internet needs and wants

**No Monthly Fees**

By the hour or weekly salary time slots

Email or fax us for price & procedures

**Let us be your Online Purchasing Agent**

Describe what you are looking for and we will try to find it!

Aunt Barbies  
East Earl, PA

717-656-9576 • Fax 717-591-4160 • [mose@aubbarbies.com](mailto:mose@aubbarbies.com)  
use email if you have it

One of the most glorious messes in the world is the mess created in the living room on Christmas day.  
Don't clean it up too quickly.

~Andy Rooney



YOUR SOURCE FOR QUALITY  
CARRIAGE & WAGON SUPPLIES

**Now Available!**

Archer Advantage Rubber Formula  
for carriage wheels

All sizes in stock for prompt  
shipping!



**Quality** ---,  
Wheel Bearings

- Longer Life
- Smoother Rolling
- Less Wear
- Less Vibration



**Hub Covers**

- Protects seals from  
water & dirt.
- Easy to install.



**Quality** ---,  
Laser Cut Parts



1030E - Gear  
Brace End

1046 - Spring  
Plate



1031A - Perch Brace

**Shipping Parts By**  
USPS, UPS, & UPS Freight

972 Newswanger Rd.  
Ephrata, PA 17522

Ph: 717-354-2732 | Fax: 717-355-0496

**Built to Last. Built in America.**



**5 Year Warranty**

- round or hex drive
- custom mounts  
available for any  
machine
- we manufacture  
augers 4" to 48"  
diameter



CALL us to learn more!



640 Baseline Rd E, Shiloh, OH 44878 • 419-752-0203

**Forklift Parts, Sales,  
Service & Repair**

Your one source for forklift parts for all makes and models



- Tires and Wheels
- LP Tanks and Accessories
- Seats
- Lights
- Filters and Tune-up Parts
- Engine, Transmission and  
Brake Parts

**Attachments**

- Fork Positioners
- Side Shifters
- Clamps
- Rotators
- Lumber Forks and  
Standard Forks
- Extra Wide Carriages

**We now stock  
Cantilever Racking,  
Pallet Racking, and  
Gondola Shelving.**



Your #1 Source for Motor, Transmission & Hydraulic Repairs on Your Equipment and Shop with Experienced Mechanics to take care of all your repair needs.

**RENTALS up to 30,000 lbs.**  
Diesel & LP Gas

5736 Lincoln Hwy, Gap, PA 17527  
717-442-9334 • 1-888-442-9330 • Fax: 717-442-2998  
www.Samsmechanical.com | Parts@samsmechanical.com





# PantoRouter®

**Precision woodworking  
has never been easier.**



- Mortise & Tenon
- Box Joints and Dovetails
- Set-up to glue-up in minutes
- Easy to Use
- Ideal for both hobby and professional woodworkers

Powered by



**BOSCH**

See videos and get more project ideas at [www.PantoRouter.com](http://www.PantoRouter.com) or call (877) 333-7150



## LOOKING FOR **HYDRAULICS** AND **DRIVE SYSTEMS?**



w/Metering Features

**WE DESIGN AND SUPPLY FOR  
HIGHER PERFORMANCE!**

**POWER SYSTEMS  
& SUPPLY, LLC**

Hydraulic Systems & Drive Systems  
Hobby & Industrial

**765-435-3733**

10381 South 800 West, Waveland, IN 47989

Call For 222 Page  
Full-Color  
Catalog with  
Technical  
Information  
and Pricing



Harvest more business by  
increasing your advertising coverage...

# PCB EXTRA

... ask about advertising in the PCBExtra.  
Call 717-362-1118



# Christmas Apologetics

Thomas Bauman

One of my strongest memories of Christmas of 2020 is standing in our kitchen, disheartened by California's second COVID lockdown and suddenly realizing that Christmas was almost upon us. Due to the unique circumstances and inability to participate in the usual events of the Christmas season, I had hardly given the upcoming holiday a second thought. I exclaimed to my wife "It just doesn't feel like Christmas this year!"

One of the many lessons that COVID has taught me is that my awareness of the birth of Christ is experienced more fully when it is celebrated along with my community, as part of the Christmas season. As we move together through a progression of traditional events leading up to Christmas, our focus is sharpened and anticipation grows. Even a secular neighbor may drop his guard a little and graciously accept gifts, well wishes, and even singing of carols. Finally, on Christmas day, the entire community can rejoice together in collective celebration of the birth of Christ.

Human nature is made for the ebb and flow of seasons, and most of us have probably found that our personal devotion is reinforced when we set aside a certain day and "[regard] it unto the Lord" (Romans 14:6). In addition to personal days of remembrance, there are also certain days that we, as communities, set aside as special days. The fresh beginning of New Year's Day may be marked by a special church service. Palm Sunday is almost always highlighted in that day's sermon. The entire following week is Passion week, culminating with Jesus' death on Good Friday, which may have a special church service for that day. Resurrection Day is celebrated in my home congregation with a full weekend-long Love Feast. Ascension Day, for many of the readers of PCBE, may be a day off work. Pentecost, in my own Brethren tradition, is often marked by a church conference, as the whole church comes together "in one accord in one place". In the fall, some congregations will set aside a day for a

"Harvest Meeting". Later in the fall, we have the national holiday of Thanksgiving. And then finally, Christmas....

...Or do we celebrate Christmas? There are some who would have no problem with any of the above-mentioned holidays, but who find the joy of the Christmas holiday marred by a certain amount of uneasiness with the whole season. The most commonly repeated concern seems to be that December 25<sup>th</sup> is of unholy origins, having no historical connections to Christ's actual birth, and is rapidly returning to those pagan roots in the modern materialistic "Xmas" party.

We can appreciate fellow Christians, who, out of conscientious scruples similar to the above mentioned, may abstain from Christmas celebrations. The scripture is very clear that we should respect differing convictions on the subject:

*"One man esteemeth one day above another: another esteemeth every day alike. Let every man be fully persuaded in his own mind. He that regardeth the day, regardeth it unto the Lord; and he that regardeth not the day, to the Lord he doth not regard it." (Romans 14:5-6a)*

However, this negative theory of the origins of Christmas springs from faulty information. This article will attempt to shed more light on the origins of the Christmas holiday, and hopefully, in the process, clarify a few controversial points on how Christ may truly be honored by a joyful celebration of Christmas.

## The Date of Jesus' Birth

Of course, there is no Biblical record of the exact date that Jesus was born. Furthermore, there is no surviving record that the Apostolic church celebrated any date for Jesus' birth. Most encyclopedias will tell you that December 25<sup>th</sup> was not highlighted as the date of Jesus' birth until the early 300s AD, about the time that Christianity was gaining legal acceptance and Constantine was beginning to unite church



and state. This fact is central to the arguments that Christmas is a pagan holiday in Christian dress. However, more in depth scholarship may be upsetting that narrative. It turns out that these ancient traditions were not so far off after all, and that there is historical mention of the December 25<sup>th</sup> date at least a full hundred years before Constantine.

Interestingly, both the Eastern church and the Western church arrived at dates to celebrate Christ's birth apparently independently of each other, but that still closely coincided in time frame. The Western church, consisting roughly of western Europe, celebrated December 25<sup>th</sup>. The Eastern church, consisting roughly of eastern Europe and the Near East, celebrated January 6<sup>th</sup> as the date of both Jesus' birth and his baptism. Over time, the two holidays crossed the geographic lines, and the Eastern church's date is now celebrated in Western Europe and America as Old Christmas, or Epiphany.

How is it that both the Western and Eastern churches independently arrived at Christmas dates that so closely coincided with each other? The precise answer appears to be lost in the mists of time, but there are several logical possibilities.

It is possible that the date was selected based on the fact that Jesus died on the feast of the Passover. Some early Christians believed that Jesus had died on the same day that he was conceived. Calculating a nine month gestation from Passover gives an early winter birthdate.

Another early belief held that Jesus' conception was on the same day that light was created. Since the world was believed to be created in the Springtime, on March 25<sup>th</sup>, it was believed that the Incarnation, or conception of Jesus in Mary's womb, had also occurred on March 25<sup>th</sup>. This theory is advocated by multiple writers; possibly being mentioned as early as the year 221, in the earliest known complete chronology of world history to be produced by a Christian author. Obviously, the addition of 9 months for the gestation of Mary would neatly yield a December 25<sup>th</sup> birthdate.

It is also possible to use Zacharias' appearance in the temple to conjecture an approximate date. Luke says that Zechariah was "of the course of Abia". This is important information, since the priestly families took their turn at the temple in a certain rotation. Alfred Edersheim, a converted Jew who wrote the classic work *The Life and Times of Jesus the Messiah*, triangulates from Zecharias' appearance in the temple, and

the death of Herod the Great, to calculate an early winter birthdate for Jesus.

Hippolytus was an early Christian author that was born about the year 170 AD. He had a relatively direct tie to the Apostles, being a disciple of Irenaeus, who was a disciple of Polycarp, who was an associate of the Apostle John. Writing in about 210 AD, Hippolytus states:

"For the first advent of our Lord in the flesh, when he was born in Bethlehem, eight days before the kalends of January [December 25<sup>th</sup>], the 4<sup>th</sup> day of the week [Wednesday], while Augustus was in his forty-second year, [2 or 3BC] but from Adam five thousand and five hundred years."

This authenticity of this statement is somewhat controversial, but there is good evidence for the validity of its authorship. If true, it is a startlingly clear affirmation of the legitimacy of the December 25<sup>th</sup> date, given more than a century before Constantine.

The Ancient World knew Dec 25<sup>th</sup> as the day that the sun began to increase in strength after the solstice. Cyprian, writing in 243 A.D. sees the December 25<sup>th</sup> date, not as an affirmation of pagan sun worship, but as a fitting day for the Sun of Righteousness to be born. He exclaims:

"O! The splendid and divine Providence of the Lord, that on that day, even at the very day, on which the sun was born [Dec. 25], Christ should be born."

While not all early church writings are united on the subject - Clement of Alexandria, for example, proposed that Christ may have been born in the spring- it is clear that the traditional date has support from early church fathers well before Constantine. Significantly, there is no other date or time of year that has agreement from multiple authors - December 25 is the only date that has that distinction.

Modern critics of the December 25<sup>th</sup> date will often confidently dismiss any evidence in favor of that day with the common argument. "It couldn't have been in the winter time because it would have been too cold for the shepherds to be in the fields!" To the early Christians, however, who may have had firsthand experience with mild Mediterranean winters and the habits of shepherds, this probably would not have been an objection. From an animal husbandry standpoint, it is possible that the presence of shepherds

One of the many lessons that COVID has taught me is that my awareness of the birth of Christ is experienced more fully when it is celebrated along with my community...

*Christmas Apologetics - Continued on Page 126*

keeping watch in the fields is actually *indicative* of an early winter birthdate. The usual practice of Israelite shepherds, as described in John 10, was to place flocks in a fold at night. This age-old technique, still followed today in some part of the world, decreases the risk of attack by predators and reduces the need for shepherds to keep watch. The shepherds of Luke 2, however, were still in the fields, keeping watch over their flocks through the night. This may suggest that it was lambing time, and that the shepherds wanted the sheep to give birth in the clean grassy fields, rather than the dirty confines of an unroofed sheepfold, likely quite mucky from the winter rains. A night in the fields would place sheep at greater vulnerability to predators, requiring the presence of multiple shepherds to keep watch through the night, as well as to assist the laboring ewes and newborn lambs.

It is interesting to note that the normal lambing time, for the native Awassi sheep of the Holy Land, is December through January. Is it not reasonable to suppose that the birthday of the Lamb of God would coincide?

### The Winter Solstice and Pagan Feasts

It is, of course, undeniable that the winter solstice was a major focal point for the pagan peoples of Europe. December 25<sup>th</sup>, being the day of the winter solstice on the Julian calendar, was marked by a Roman feast that celebrated the rebirth of the sun. Some writers have even noted similarities between the pagan feast and Christmas, such as the giving of gifts. Many modern-day Christians have too quickly concluded that the early church, by celebrating Jesus' birth on December 25, were doing so in order to carry on previous pagan traditions. This is overly simplistic. It is more likely that the 4<sup>th</sup> century church celebrated a December 25<sup>th</sup> holiday, not as a camouflaged pagan tradition, but rather *in disregard* to the ongoing pagan festivals.

A modern-day example of the same concept can be found within my own church community. Every October, our private school holds an annual open house. This well-attended event is often held on Halloween. A misinformed critic might claim we are celebrating the Dark World by holding our open house on Halloween, but the exact opposite is actually true. Our

school holds its open house on Halloween, not to celebrate Halloween, but because we are deliberately indifferent to it.

It is likely that the early Christians may have dealt with the pagan feasts around them in a similar way. The end of the year was a major focus of pagan celebration, and naturally so – the short, cold winter days tend to reduce the length of the workday and allow more time for gathering and celebration during the long winter evenings. It seems logical that the early Christians would choose to spend their long winter evenings focusing on something better.

### The True Joy of Christmas - Antidote to Materialism

It seems clear that celebrating the birth of Jesus on December 25<sup>th</sup> is a not an intrinsically pagan activity. However, there remains a legitimate concern regarding the massive materialism and secularization of the modern Christmas celebration that seems to overshadow the miracle of Jesus birth.

How do we prevent the worldly tide of superfluity and greed from encroaching and eroding the sacredness of our own celebrations? The answer, no doubt, is complex. One man's beloved Christmas tradition may seem to another to be a materialistic excess. Again, the biblical teaching on the relationship between the strong brother and the weak brother must come into play. As we evaluate our choices in consideration of the feelings of those around us, it may serve as a natural restraint on the excesses that are often associated with modern Christmas celebrations.

...if there was ever a time to put away our own self-willed interests and consider the feelings of our brother, it would surely be the season of "goodwill toward men".

While no physical thing is intrinsically evil (Romans 14:14) we must realize that we all have different sensitivities to different things, based on context and past experiences. For example, the early Quakers avoided referring to the given names of the days of the week, because the weekdays are originally named after pagan gods. For example, Sunday was originally Sun's Day, Monday was originally Moon's Day etc. The Quakers carefully avoided using words that invoked the pagan gods, instead saying First Day, Second Day, etc. While I appreciate the early Quaker's scrupulousness, I really doubt that there is any brother in my congregation who feels that I am honoring Thor when I ask him to meet me on Thursday.



If I were to actually have a brother in my congregation with a sincere conviction against invoking the names of these pagan gods, the situation would be very different. Paul is quite clear. I, as the strong brother in this example, should not despise the weaker brother for his sincere conviction. The weak brother, meanwhile, should not judge the stronger brother for seeing nothing wrong with using pagan names for the days of the week. Furthermore, the strong brother must realize that: *“If thy brother be grieved with thy meat, now walkest thou not charitably”*. (Romans 14:15) It is very tempting to try to devise a workaround for this verse. But if there was ever a time to put away our own self-willed interests and consider the feelings of our brother, it would surely be the season of “goodwill toward men”. In so doing, we will be able to support each other as we try to collectively resist the cultural pressures around us.

By the time this magazine arrives in your homes, Christmas will be right around the corner. People will be busily moving through the crisp air, delicious smells will be wafting from kitchens, and friendly greetings will be exchanged by men who may otherwise pass each other in aloof silence. As we come, in spirit, to journey with the faithful toward Bethlehem, our purpose is to behold our King, not to worship the sun. Luke’s Nativity account is punctuated with joyous, hopeful exclamations, should not we be joyful as well? When we greet one another on the day that has long been remembered as the birthday of our Lord, may it be with unmarred tidings of comfort and joy.

---

*Thomas Bauman lives in California with his wife and two sons. He works as a dairy veterinarian and enjoys hobby farming, beekeeping, and reading.*

“...and, lo, the star, which they saw in the east, went before them, till it came and stood over where the young child was. ~Matthew 2:9



# POWER SOLUTIONS

for your off-grid customers.

## Attention Solar Installers: Zonna Energy is here for you!

Zonna Energy is not just any solar energy equipment supplier. With decades of combined experience in off-grid solar installs, the Zonna team understands the frustrations inherent to getting the perfect combination of Solar Panels, Batteries, Racking, Inverters, and Charge Controllers for each project. If you're looking for someone who understands the industry and can help you get the right parts to the right place at the right time, partner with Zonna Energy!



### Quick Shipping

We have distribution centers in Millersburg, OH and New Holland, PA to ensure your products get shipped in a timely manner. In fact, if you order by 3 PM, your shipment will leave on the same day!



### Expert Support

With over 65 years of combined experience, we've learned the best practices and products. Our customer service and tech support will save you time and headache in finding solutions!



### Competitive Prices

You care about giving your clients great value—which means you need to find a solar energy equipment supplier with quality products at affordable prices! We've put together a complete inventory at a budget-friendly cost.

Would you like to partner with Zonna Energy? **Contact us today!**



# How can we help you?

At Zonna Energy, we offer inverters, charge controllers, batteries, monitoring systems and software, and power distribution panels from the leading brands in the industry. We even offer replacement parts and in-house inverter repair to keep you going day in and day out. With Zonna at your back, you can truly gain an edge over your competitors in the industry!

Wondering what solar brands we carry? The following is a list of all the brands that Zonna offers:



# BCS Tillers

No BELTS No CHAINS No EQUAL



Now Selling Honda Parts/Filters and Oil

### Engine Options:

- Honda
- Kohler

### Attachments Available:

- Quick Hitch
- Wheel Weights
- Wheel Extensions
- 540 - 6 Spline PTO
- Steel Wheels

### Attachments:

- Tillers
- Cultivator
- Rotary Plow
- Rotary Harrow
- Potato Plow
- Disc Harrow
- Bed Shapers
- Hiller Furrower
- Ridger
- Sickle Bars
- Brush Mowers

- Flail Mowers
- Snow Throwers
- Snow Blade
- Sweepers
- Chipper Shredder
- Log Splitter

- Sprayer
- Dump Cart
- Trailer
- Sulky and more

Free Shipping on Qualifying Orders

Heavy duty gear drive design for years of dependable service

— FALL SPECIALS IN EFFECT —  
save up to 15% plus free shipping

Attachments, Parts, Large Inventory, Great Prices  
Call for price information.

### EVERGREEN LAWN & GARDEN

2849 SWARTHOUT ROAD, PENN YAN, NY 14527  
FAX 13155364897 • EMAIL ELG@IBYFAX.COM  
**315.536.5821**



"NEW ITEM"  
Twin Spindle Finish/  
Brush Mower

# HOOVER REPAIR LLC

263 KURTZ ROAD  
EPHRATA, PA 17522  
(717) 354-2583



24" PLANER USED  
GRIZZLY G9961  
INDUSTRIAL HEAVY DUTY PLANER  
SPIRAL CUTTER HEAD  
10HP 220V 3PH  
COMPLETELY REBUILT  
ONLY \$6,800

We are a dealer for the Byrd spiral cutter head. Call us for pricing!

USED MACHINERY		
Bandsaw Resaw 27"	NORTHTEC HB700	2450
Bandsaw 14"	Delta 14"	665
Bandsaw 18"	MINI MAX S45	1390
Air Lock	Air Lock	1250
baghouse	MURPHY RODGERS MRM	2450
blower	NEW YORK series 3, APR-9	1750
dust collector	CB 2 BAG	1450
Dust Collector	CORAL	1440
Dust collector	DUSTEK 10 HP	2450
Dust collector	DUSTEK 10 HP	2450
Dust Collector	REES 1030-4, 10 hp	2150
drilling machine	Yoder 8 heads hyd.	3500
Edge Sander 6	NORTHTEC 6", NT-ES109SE, oscilating	2100
Edge Sander 7"	CROUCH 66-48	1750
Edge Sander 8	WHIRLWIND 855 Oscillating	3600
Edge Sander 9"	CANTEK PW-120E	2950
Gang Rip Saw 24"	WEING RAIMANN PROFIRIP KM-310-M	34900
glue spreader	JLT plate spreader	390
Hollow Chisel Mortiser	POWERMATIC 701	500
Horizontal borer	RITTER R-130, 1 spindle	950
Jointer 06	DELTA 52-858 6"	580
Miter Saw 12	OMGA MEC-300ST	975
Miter Saw 14	OMGA T50 3350	1250
Miter Saw 20	CTD F526	2880
Moulder 4	EXTREMA 2 x 6	3900
Moulder 4	INTERWOOD 409S, 4 head	8800
Pin Router, Inverted	ONSRUD 2408	5900
Pin Router, Inverted	ONSRUD 24210	6900
Pin Router, Inverted	ONSRUD 3025	5900
Pin Router, Inverted	ONSRUD 36210	6900
Pin Router, Overhead	Casadie R32 pin router	3900
Planer 15"	POWERMATIC 15"	680
Planer 24	BRIDGEWOOD 610AVG, 24"	5800
Planer 24	GRIZZLY G9961 24" spiral head	6800
Planer 24	SCMI S63, 24"	6800
Planer 24"	NORTHTEC NT-24-10HCVS-XL	6900
Planer 24"	ROCKWELL/INVICTA RC63	5900
Double Sided Planer 33"	EXTREMA MXP-233 33"	23750
Double Sided Planer 36"	OLIVER 2170 Straitoplane	18750
power feeder	EXTREMA 3 roll	850
power feeder	FELDER 4 roll, combi	1150
power feeder	FOREST CITY 4 roll	750
power feeder	Powermatic 3 roll	650
Radial Arm Saw	B & D DeWalt 16", 28" cut	1850
Radial arm saw	DEWALT 14" 24" cut	1850
Radial arm saw	DEWALT 16" 28" cut	1850
Radial Arm Saw	OMGA RN-450, 12", 18" cut	1850
Radial Arm Saw	OMGA RN600, 22" cut	1650
Radial Arm Saw	OMGA RN700, 26" cut	1850

Radius feeder	STEGHERR BV	575
Rotary Table Router	RYE Rotary Table Shaper	2800
Shaper 1 1/4"	CASEDEI F114, 1 1/4	3900
Shaper 1 1/4"	DELTA RS-15	2890
Shaper 1 1/4"	ROCKWELL INVICTA RS-15	2890
Shaper 1 1/4"	SCMI T130	4490
Shaper 1 1/4"	STONEWOOD STO-735m	5400
Shaper 1 1/4" Sliding Table	FELDER F7002, 1 1/4"	4900
Shaper 1 1/8"	SICAR	1990
Shaper 3/4"	DELTA 3/4"	1250
Shaper 3/4"	DELTA 43-375, 3/4"	1250
Shaper 3/4"	GRIZZLY G8622	1990
Shaper 3/4"	MINI MAX T3	1450
Shaper 3/4"	MINI MAX T4, 3/4"	1800
Sliding table saw	SHOP FOX W1811, 10", 5'	6900
Straightline Rip Saw	ACTIVA	10900
Straightline Rip Saw	DIEHL SL52	17900
Straightline Rip Saw	DIEHL SL52-OSHA	21900
Straightline Rip Saw	DIEHL SL52L left hand	17900
Straightline Rip Saw	DIEHL SL55	13900
Straightline Rip Saw	MATTISON 404	12900
Straightline Rip Saw	NORTHTECH SRS12	8900
Straightline Rip Saw	POWERMATIC SLR-12	8900
Straightline Rip Saw	SECO SK-12TK	11900
Straightline Rip Saw	SECO SK-12TR	7900
Table Saw 10	DELTA/ROCKWELL Unisaw	1390
Table Saw 10	JET 10" Table Saw	1190
Table Saw 10	POWERMATIC 66	1790
Table Saw 10	POWERMATIC 66	1890
Table Saw 12	DELTA RT31, 12"	1990
Table Saw 12	Mini Max SI-10	1990
Table Saw 14	Delta/Invicta RT40	2890
Table saw 14	POWERMATIC 72	2390
Tennonner	BACCI TSG2T	5500
Tennonner	TRANSPower YRT 100	7800
Upcut saw 14L	INDUSTRIAL C500L	2490
Upcut saw 14L	PISTORIUS	2450
Upcut saw 14L	WHIRLWIND 1000L	2950
Upcut saw 14R	WHIRLWIND 1000R	2950
Upcut saw 18L	GRIZZLY G0502	2950
Upcut saw 18L	INDUSTRIAL N510L	3950
Upcut saw 18L	SECO SK-18PCS	3250
Upcut saw 18L	TRI STATE/INDUSTRIAL T510L	3950
UPCUT SAW 18L	WHIRLWIND 212L	4250
UPCUT SAW 20L	WHIRLWIND 216L	5950
VERTICAL PANEL SAW	HOLZ HERR, 1265 Supercut	8650
VERTICAL PANEL SAW	HOLZ HERR, 1265-S Compact	10650
VERTICAL PANEL SAW	SAFETY SPEED CUT 6400	1450
WIDE BELT SANDER 15 1	GENERAL 15-030M1, 15"	2200
WIDE BELT SANDER 15 1	SHENG SHING SDM15	2900
WIDE BELT SANDER 25 1	SHENG FENG	2850
WIDE BELT SANDER 37 1	CEMCO 2000, 37"	5900
WIDE BELT SANDER 37 1	Conestoga 36"	4900
Wide belt sander 37 1	KUNDIG Optiq	9750
Wide belt sander 37 1	TIMESAVER 237	8900
Wide belt sander 37 2	SECO JS 360P	10900
wide belt sander 37 2	TIMESAVER 137-2hp75	13600
Wide belt sander 43 1	BUTFERING, Classic 111-E	13800
Wide belt sander 43 2	NORTHTEC NT-EV-1100RC	19600
wide belt sander 43 2	TIMESAVER 2300, 43"	18600
Wood grinder	WOOD POWER	7900



**DRIPSTOP**  
Condensation control

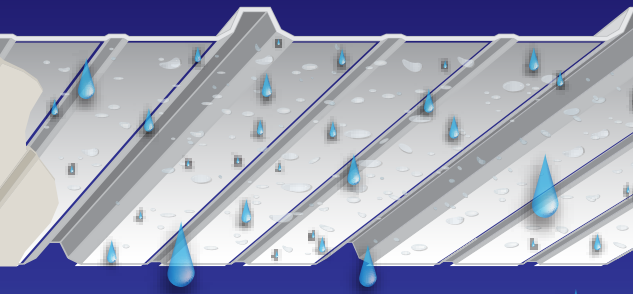

# Increase Profits Not Labor Costs

**A Necessity for Any Metal Roofed Building That is Not Climate Controlled.**

- Post Frame/agricultural buildings
- Steel buildings
- Self-storage
- Workshops/unattached garages
- Open-walled structures
- Carports, truck ports & RV storage

## Better Science Equals Drier Buildings

When condensation occurs, moisture gets stored in the specially designed pockets of the DripStop membrane.

- Helps fight corrosion in livestock confinement
- Arrives on-site already on roof panels
- Cuts construction time in half
- Saves money

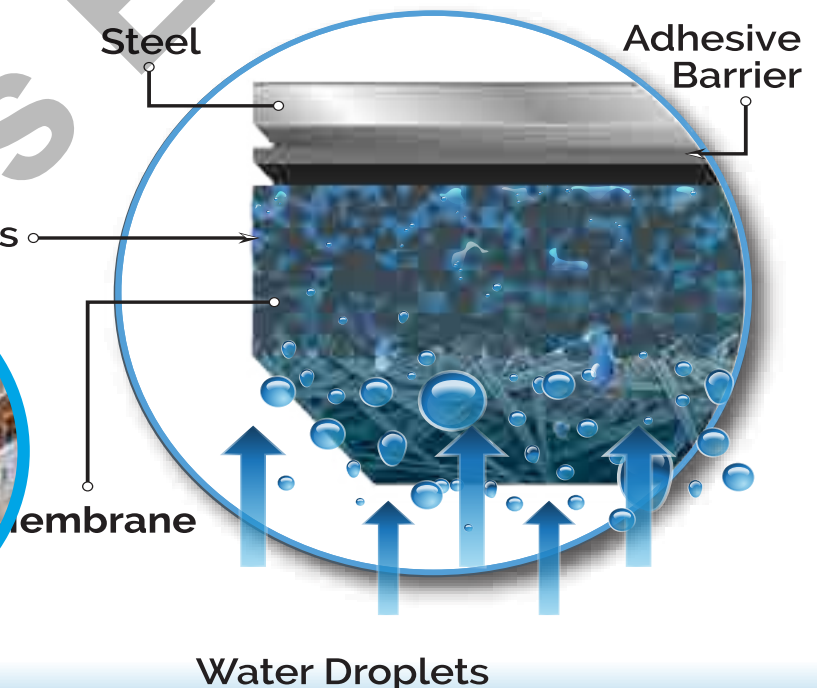

**DRIPSTOP**  
Condensation control



**Fight Condensation Without Insulation**

Ask for it from your preferred steel panel supplier

[www.dripstop.com](http://www.dripstop.com) or call us at: 1-(937) 660-6646

**5% OFF SPECIAL for NEWLY-WEDS!**

**Junior Bin Holds 650 lbs** 48"W x 24"D x 55" H

**Senior Bin Holds 1200 lbs** 68"W x 29"D x 59" H

- Heavy duty • Keeps rodents out
- Keeps feed fresh
- Powder coated for durability
- Slide on bottom of scoop box to fill buckets

Options: w/ Wheels & w/ Hinged Lid

**NEW BIN STYLE!**



**Agri-DOOR I LLC**  
Unlimited Silo Doors & Hardware

Bin here. Bin there. Bin everywhere!

**(717) 949-2034**

649 S. RAMONA RD. • MYERSTOWN, PA 17067 • AGRI-DOOR.COM



**Athens TREADMILLS**

Model 106 - One-Horse



One-Oxen



Above 106 Treadmill equipped with STP Stairstep Tread and optional transport gear, air compressor, and hydraulic accessory.

**These Versatile Treadmills Are Used By:**

- Horse Trainers - to break and exercise horses
- Farmers - to keep horses muscled-up during off-season
- Horse Lovers - to exercise their horses and keep them trim
- Universities - for exercise with ideal front and rear leg ratio
- Back to the Basic / Off Grid - for all the above reasons, plus providing your own power

**FEATURES:**

- Heavy white oak construction
- U.V. resistant finish
- Heavy-duty oil bath gear drive train
- Gear-case doubles as hydraulic reservoir
- 2 1/2" x 10" wide white oak stairstep-type tread (level treads optional)
- All web links and shafts of medium carbon steel
- Web rollers sealed for life, deep groove ball bearings
- Dual jacks for stability
- Adjustable speed governor
- Adjustable ramp angle to match animal's endurance or power required

- Double floor for safety
- Rear bar for security

**SPECIFICATIONS\*:**

- 2500# approximate weight
- 66" wide x 120" long x 92" high
- 500 RPM nominal output speed
- Walking speed adjustable from approximately 1.5 to 3.5 MPH
- Power output approximately 1 HP depending on ramp angle, walking speed, and animal weight
- 2 GPM hydraulic system (optional)
- 30 amp, 12 volt battery charging system (optional)



To order or for more information write or call:

**600 Eagle Way, Spencer, TN 38585**

Phone: 931-946-1650, 7:00 - 8:00 AM - Central Time, Weekdays

\*Subject to change without notice.

**PREMIUM White Gas**

White Gas, Clear Gas, Lantern Fuel, Rubber Solvent

- ▶ Our Trucks with lift gates deliver in the midwest.
- ▶ Any size order will be taken.
- ▶ Must be tractor trailer accessible.
- ▶ New drums with every order.
- ▶ Our truck will pick-up empties



Innovative Solutions for Industry and the Environment

Call Bill Garrett for pricing.  
Cell: 216.536.5253

**ZARKS & BEST WATER ENERGIZER!**

**ACTIVATES YOUR DRINKING WATER.**

Improve you family's health by breaking up water molecules. It hydrates more efficiently, eliminates unwanted toxins and increases your body's energy.

**NEW WATER ENERGIZERS**

combined with filter and/or softener, also features a manual backwash to achieve completely clean water.

Also benefits animals, birds, crops and more ... less water, more yield with no cost to operate or maintain.

**NEW UPGRADED UNITS - BETTER RESULTS**

**ZARKS ENERGIZE WATER SYSTEMS LLC**

**BRIAN - ZARKS and BEST**

**330.217.8706**

**3263 Bath Road, Akron, OH 44333**





# WINTER TOOL DEALS!



**XT288T**  
18V LXT® Lithium-Ion Brushless Cordless 2-Pc. Combo Kit (5.0Ah). Included XPH14Z & XDT16Z (2) 18V LXT® Lithium-Ion batteries, Rapid Optimum Charger, bag

**NEW!**  
More power!  
Extra heavy duty!

**FREE!**  
6.0 amp battery



BL1860B

**FREE**  
bare tool with purchase



**XSH06PT**  
36V (18V X2) LXT® Brushless 7-1/4" Circular Saw Kit (5.0Ah)

**\$100**  
INSTANT REBATE

**FREE**  
bare tool with purchase

## FREE! BARE TOOL CHOICES



DMLB12



XPH12Z



XWT13ZB



XRW01Z



XLC07Z



XSF03Z



XAG04Z



XAG25Z



XMT03Z



XRJ04Z



XSS02Z



DMP180ZX



XVJ03Z



XOB01Z



XTR01Z



XBU03Z



XLC02ZB



XRM06B

## A NEW SYSTEM OF EQUIPMENT & TOOLS 40V | 80V max BEYOND LIMITS

**FREE!**

**4.0 AMP XGT BATTERY WITH THE PURCHASE OF A KIT OR TWO BARE TOOLS**



40V | 80V max



**GWT05D**

40V max XGT® Brushless Cordless 4-Speed 1/2" Sq. Drive Impact Wrench Kit w/ Detent Anvil



**GAG01M1**

40V max XGT® Brushless Cordless 4-1/2" / 5" Cut-Off/Angle Grinder with Electric Brake



**GSH01M1**

40V max XGT® Brushless 7-1/4" Circular Saw Kit



**GRH01M1**

40V max XGT® Brushless 1-1/8" AVT® Rotary Hammer Kit



**GRJ01M1**

40V max XGT® Recipro Saw Kit



**GPH01D**

40V max XGT® Brushless Cordless 3/4" Hammer Driver-Drill



**GDT01D**

40V max XGT® Brushless Cordless 4-Speed Impact Driver

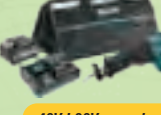

**GT200D**

40V max XGT® Brushless Cordless 2-Pc. Combo Kit (2.5Ah)

40V | 80V max also available as bare tools.



**XEC01PT1**

36V (18V X2) LXT® Brushless 9" Power Cutter Kit, with AFT®, Electric Brake, 4 Batteries (5.0 Ah)



**XCU03PT1**

36V (18V X2) LXT® Brushless 14" Chain Saw Kit with 4 Batteries (5.0Ah)



**XBU02PT1**

36V (18V X2) LXT® Brushless Blower Kit with 4 Batteries (5.0Ah)

# Stoll Brothers

Complete Supplier of Woodworking Tools and Machinery

P.O. Box 367, 509 S.E. Street, Odon, IN 47562

**(800) 603-8923**

Call us for pricing or for a free catalog. Table Saws, Planers, Band Saws, Sanders, Jointers, Wood Lathes, Cordless Tools & More...

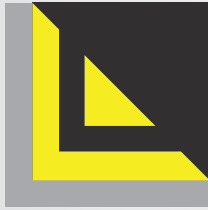

**LAPP MILLWRIGHT** LLC  
 CONSTRUCTION & MAINTENANCE  
*of Dust and Fume Collection Equipment*

— 12 DAYS OF CHRISTMAS —

**12% Off** **DECEMBER SALE!**



**Dust Collectors**



1.5 hp W1685

2 hp W1666

3 hp W1687

TAKE 12% OFF YOUR ORDER!

**Rolled Lip Duct**



TAKE 12% OFF YOUR ORDER!

**PREVENTATIVE MAINTENANCE...SIGN UP BEFORE 2022 AND RECEIVE 1<sup>ST</sup> 2 SERVICE CALLS FREE!!**

CALL FOR A **FREE** CATALOG!

We ship via UPS



**COME SEE US AT A SHOW IN JANUARY 2022!**

KEYSTONE FARM SHOW - JANUARY 4-7

NORTHEAST TOOL SHOW Stanley NY - JANUARY 14-16

MIDWEST TOOL EXPO Shipshwana IN - JANUARY 28-29



Phone: 717.865.3521 Fax: 717.865.3526 • 93 TROY AVE., LEBANON, PA 17046



# PROTECT YOUR LEGS

with high quality farrier's aprons

Ask for Bowman Farrier's Aprons at one of our dealers.

Tell our dealers you saw their name in PCBE

On the ground, knocked out of breath.  
Pants in frazzles – Oh what a mess!  
(hadn't worn his apron)

- double thickness Cordura®
- leather knee patches
- knife pocket on each side
- removable magnet on left leg
- side release buckles for convenient operation
- break away snap/hook snap combo on the leg straps for your safety



For Wholesale Price contact...  
Bowman's Harness Shop LLC  
54271 CR 43, Middlebury, IN 46540  
(574) 825-9569 ext 3

- Clymer Hill Horseshoeing ..... 716-355-4177  
1391 Clymer Hill Road Clymer, NY 14724
- Creative Custom Builders LLC ..... (641) 364-2140  
1255 Durham Avenue, Alta Vista, IA 50603
- Diamond Harness & Sales LLC ..... (574) 773-5454  
10023 W 1350 N, Nappanee, IN 46550
- Good-Old-Days Farrier Supplies ..... (660) 458-8019  
37493 Higgins Rd, Fortuna, MO 65034
- Hershberger Horseshoeing Supply ..... (440) 834-9125  
16729 Jug Road, Burton, OH 44021
- Kauffman Farrier Supplies  
S. 1309 Mast Road, Cashot, WI 54619
- Kurtz's Horseshoeing  
29353 St. Hwy NN, Jamesport, MO 64648
- Mast Horseshoeing and Supplies ..... (574) 825-7565  
10376 C.R. 10, Middlebury, IN 46540
- Master Farrier Supply ..... (218) 924-4326  
13152 430th St. Bertha, MN 56437 (8:00-8:30 AM CTZ M-F)
- Mountain Hardware ..... (931) 946-2267  
239 Army Camp Rd., Spencer, TN 38585
- Pine Ridge Repair ..... (260) 463-2461 ext 1  
3460 W US 20, LaGrange, IN 46761
- Plank's Harness Shop ..... (217) 543-3135  
150 CR 000 N, Arthur, IL V61911
- Schlabach Carriage ..... (814) 427-2398 ext 1  
689 Deer Drive, Punxsutawney, PA 15767
- Schmidt Mfr.  
2507 N. Leval Ratts Rd., Salem, IN 47167
- Schwartz Farrier Supply LLC ..... (574) 642-1250  
2194 U.S. Hwy 27, Berne, IN 46711

# Uni-Hydro Iron Workers and Shears

## Model 45-14

From farm repair to industrial fabrication these powerful machines have it under control



## Model PRO 80

- 30-150 Ton Machines
- All parts and tooling available
- 13 Models to choose from

Call for Info and Quotes  
FREE SHIPPING  
upto 1,000 miles

## City Hill Fabricating LLC

Penn Yan, NY 14527  
Phone/Fax 315-536-4576  
Cell 315-759-3049



FREE CATALOG



## Huge Selection of Gardening Supplies

Your One Stop Garden Shop

Mail Orders • Phone Orders • Online Orders

BIRD SEED  
LARGE SELECTION  
BIRD FEEDERS



## Garden Seeds

- Sprays - Insecticides
- Fungicides
- Fertilizers
- Soil Amendments
- Hard Goods
- Flower Seeds
- Flower Bulbs

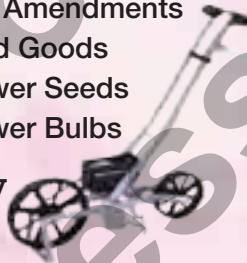

Dutch Garden Nursery



Earthway Garden Seeders

660-397-4115

Online ordering available at  
www.dutchgardennursery.com

51877 Daffodil Loop  
Edina, MO 63537

## AMERICAN EAGLE WINDMILLS, LLC

13053 W Ridge Road, West Springfield, PA 16443  
phone: 814.922.3180 | fax: 814.922.3185



Ice Tongs  
Ice Cleats

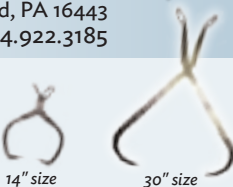

14" size

30" size

## Ice Saws

- Powder coated frame
- Width & Depth Adjustable
- Runner Guide for same width blocks
- Easy in & out of ice
- Fits most chain saws

MADE IN THE USA

Chain saw not included.

## Country View Enterprises

2244 Noble Road E, Shiloh, OH 44878

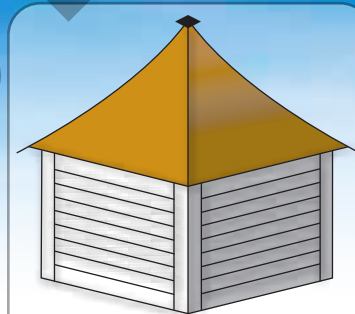

Cupolas of all sizes - Starting at \$220.00  
Square, Hexagon and Octagon - Louvered  
or Poly Window, Base Flashing Kit Included

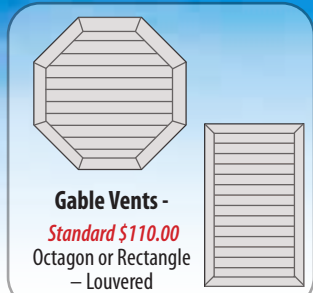

Gable Vents -  
Standard \$110.00  
Octagon or Rectangle  
- Louvered

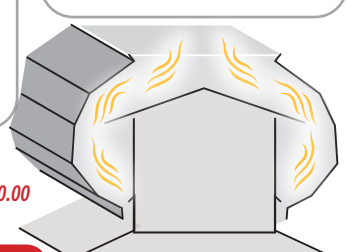

Ridge Vents -  
RV 100...\$55.00 RV 35...\$105.00 RV 900...\$160.00  
Improve your building life, and the looks.

Short Lead Time | Shipping Available

Christmas is a tonic for our souls. It moves us to think of others rather than of ourselves. It directs our thoughts to giving.

~B.C. Forbes

# THE EXODUS CASE BOOK

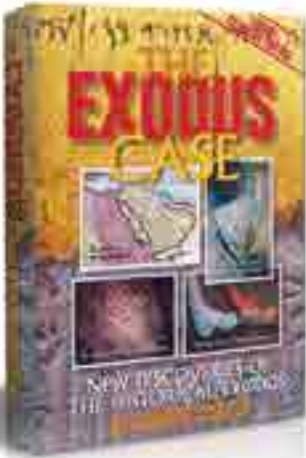

THIS EXCITING BOOK supports the Biblical story of the Exodus. It reveals discoveries of a team of scientists and researchers in the footsteps of Moses and the Israelites on their journey from Egypt to Canaan. Join Dr Moller on his journeys and study for yourself this stunning material supported by more than 500 new color photos and detailed satellite images. 570 photos & illustrations support the text & point to the reliability of the Bible. Hardcover with dust jacket. 450 pages.

ITEM # TEC-101  
**\$39.99**



**AIS**

**Alron Integrity Sales**

13949 Claridon Troy Road | Burton, OH 44021

Contact us for a free wholesale or retail catalog.

CALL TODAY TO PLACE YOUR ORDER | p. 440.834.1765

Payments Accepted: Cash, Check & Credit Card | Wholesale Inquiries Welcome

Ohio residents add 6.75% sales tax - 250+ receives free shipping

Shipping Rates: 0-49.99: 7.50 | 50-99.99: 10.00 | 100-174.99: 12.50 | 175-249.99: 15.00

# ASK FOR IT BY NAME DER BLITZ



Feather-light with a tougher, longer lasting outsole!

Calf & Knee Heights

Sizes 4-14

Extra cushion under foot

Easy on/off

Great value

WORK Light

By: RED FOOTWEAR

Also look for our NEW WORK LIGHT Youth Boots  
 EVA • Extra comfortable • Starting at size 9

Bag Man, LLC PO Box 162 Hammond, WI 54015 | Phone: 800-796-5333 | Fax 715-796-5655

Are you looking for a way to heat your shop?

Try an exhaust Heat Exchanger

*Don't throw your diesel heat away.*



No Diesel to Large • No Diesel to Small

**WE WILL DESIGN A SYSTEM TO FIT YOUR NEEDS**

Call or write DJS Welding for more information:

**DJS Welding LLC**

221 Long Lane, Coburn, PA 16832

814-349-5060 — 8:00am to 8:15am

## STOP IN TODAY & SHOP FOR SHOES

29999 Co Rd 56, Nappanee, IN 46550 • (574) 773-4279



Enjoy a quick makeover with some new  
**Area Rugs!**



**Call For Current Inventory!**

- ☑ **100s** In-Stock
- ☑ **CUSTOM** Rug Binding
- ☑ **STAINPROOF**
- ☑ **OUTDOOR**
- ☑ **COMMERCIAL**
- ☑ Local **DELIVERY** or **SHIPPING** Available

**FLORHAUS**

FLOORING DESIGN CENTER

**(717) 656-7077**

40 Glenbrook Rd (Rt 772) Leola

Mon-Fri 8-4, Sat 8-12

PA-HIC #033474

Hardwood • Laminate • LVT • Ceramic Tile • Carpet • Vinyl  
 Window Shades • Paint • Refinishing • Accessories

*Hilti's*  
**RADIANT**  
*Energy LLC*

**UNBELIEVABLE  
 LOW PRICES**



Used 250 watt  
 solar panels  
 \$ 75 each  
 \$ 55 each skid

**EXTREME DEEP CYCLE BATTERIES**



40 AH \$245



100 AH \$550

**USB & VOLT  
 METER,  
 THOUSANDS  
 OF CYCLES,  
 CYLINDRICAL  
 CELLS**

2989 W 200 S Monroe, IN 46772

**VM 260-301-2095**



*Electronic Payment Solutions for All Business Types*

**100% WHOLESALE  
 PASS-THRU**

**NO MINIMUM  
 NO CONTRACT  
 NO PCI FEES**

**CUSTOMER  
 SERVICE LIVE**

**BEST PRICING**

**EMV EQUIPMENT  
 AVAILABLE**

**DEBIT RATES  
 AS LOW  
 AS 1.29%**

**SECURE PRIVATE  
 LABEL WIRELESS  
 CONNECTION**

**FASTER THEN  
 STANDARD  
 PHONE LINE**

Knowledge | Trust | Savings

- » Managed VT Gateway Billing Programs
- » Free Honest Analysis
- » Understand Your Options
- » Serving the Plain Community Since 2010

A Business Development Company  
 Call Today 1-866-677-1608



*Electronic Payment Solutions for All Business Types*

info@merchantserviceconsultants.com | www.merchantserviceconsultants.com

**ULTIMATE CHANDELIER**

**Finally a Candlelight  
 Chandelier**

\$495



**32" ceiling**

Featuring a 2-stage touch switch with 25 watts of warm light or switch to candlelight mode and enjoy the coziness of flickering candles.

- Touch switch is standard.
- Remote switch optional.
- Retail or Wholesale.

**26" wall**



\$320

**518-225-8497**

121 Greene Rd • Sharon Springs NY 13459

# WARMING THE HOME

with Borntrager's  
**TRUE HEAT WOOD BRICKS**





## LEROY MARTIN

With winter's chill bearing down on most of the United States, the task of heating our homes for the next several months is something we must contend with. Mervin Bortrager of Bortrager's True Heat Wood Bricks believes he might have a practical product that could heat homes in an efficient manner. Recently, he explained how he acquired a business that produces briquettes via an interesting machine from a fellow in his community.

The previous owner of the wood brick production business had explored a cordwood alternative. For several years, he had provided his clients with an option that helped them skirt the task of carrying bundles of firewood throughout the winter. It had been a reliable business due to a robust market, however; a decision was made to sell the company to Mervin Bortrager. Immediately upon acquisition, Bortrager rebranded and renamed the business Bortrager's True Heat.

Mervin explained that he had wanted to acquire the business from the previous owner the moment it had become available for purchase. "I wanted to provide work for my mother, Edna. My hopes were that I could add automation to the brick making process in a way that she could handle it on her own. So far, it looks like it worked out all right for us," he said, pointing to some upgrades he had made since installing the equipment in his facility. (His mother lives on the same property and works from his facility).

Since December 2020, Mervin has been producing wood bricks in a 60x60 facility. The bricks are formed from sawdust and are produced via a *Weima* machine. "The machine compresses kiln-dried sawdust into a brick. One-hundred-thirty-five tons of pressure is applied, forming the bricks without any binders or glue. No moisture of any kind is added, it is critical to keep the sawdust as dry as possible prior to producing the bricks," he said.

Every 6.50 seconds, a hard brick is formed from sawdust when the machine is in operation. Within two hours and fifteen minutes, a pallet of bricks—the equivalent of an average cord of firewood—can be formed. "One pallet can hold one ton of wood bricks," he remarked.

Folks have been attracted to wood bricks for several years now, due to their reliability and ease of access. "There is no need to cut or stack piles of firewood when using these bricks to heat your home. The bricks are shrink wrapped in bundles of sixteen. The bundles are very easy to handle,

since each bundle weighs only thirty-two pounds. This makes it an ideal heating option for older folks who might struggle carrying heavy firewood," he added.

Majority of folks who have switched to wood bricks say they enjoy the practice of being able to grab a pre-wrapped bundle of sixteen bricks and tossing the entire bundle, plastic and all, into their stoves. "It is much cleaner than burning firewood or coal, because both those options produce a significant amount of ash, whereas the wood bricks produce noticeably less," Mervin explained.

Although majority of his clients toss an entire bundle of sixteen bricks into their stoves, Mervin strongly suggests new clients to experiment slowly, perhaps introducing only a few bricks to their stove. "It's a good idea to only add a few bricks the first few times, to see how the stove reacts." (He says this from an abundance of caution. He has not heard of fires burning uncontrollably simply due to the introduction of the bricks. Still, experimenting is a good idea).

"Our wood bricks produce sixty percent less ash than regular firewood, and ninety percent less ash than coal," Mervin explained. "There is certainly less smoke, too, when compared to regular firewood."

One bundle of wood bricks typically burns nicely for ten to twelve hours—if the stove is tight and in good condition. These bricks can be used in coal or wood stoves however, the experience is much more satisfactory when they are burned in a wood stove.

Another advantage that wood bricks provide is a fire that burns hotter and longer. No more continuously adding

*True Heat Wood Bricks - Continued on Page 140*



*True Heat Wood Bricks - Continued from Page 139*

firewood just to maintain a steady heat in the room on a cold winter's night. Additionally, the wood bricks are free of bugs and diseases which can often be present in firewood.

In various ways, the wood bricks are a cordwood alternative. Borntrager's True Heat bricks reach 8600 BTU's per pound. One ton of bricks provides the same amount of heat as one-hundred-forty gallons of heating oil or one-hundred-eighty-five gallons of propane. Regarding electricity, one ton of Borntrager's bricks provides an approximate heat as 4980 KWH of electricity does.

The wood bricks have useful applications beyond a stove or fireplace. "People are using the wood bricks in open grate grills. I have used them a few times as well in my open grill, and I thought the burgers tasted like they had come off a charcoal grill. I was pleased," he said. "If the bricks are stacked in a cone or pyramid shape, there will be very little smoke."

Borntrager's True Heat bricks have also been used to heat maple syrup evaporators. "One of my customers has a maple syrup business and has been using the bricks. He says he really likes them and has no intentions of burning firewood again. Before he started using our bricks, firewood needed to be added to the evaporator every four to five minutes—the wood burned up so quickly. Now, he just throws two packs of our wood bricks into the fire and its burns consistently for twenty minutes. If the fire burns down, the heat will remain for much longer."

Mervin continued to share a few more statistics from his customer's product testimonial. "He could typically produce seventy gallons of sap per hour, whenever he burned firewood in the evaporator. After using the wood bricks, his production increased to ninety gallons per hour." (This increase in production is credited to the fire burning hotter and with greater consistency).

Borntrager's True Heat only uses sawdust from kiln-dried



Sawdust which will be transformed into bricks, is piled high at the facility.

Image Credit: Leroy Martin



wood from several local woodworking shops. They receive a semi-load of sawdust on a regular basis. Each load contains twenty-two tons of sawdust. Approximately four hours are needed to unload a semi-trailer. The task is conducted by utilizing a forklift equipped with a standard-size scoop attachment.

The upgrades to Mervin's briquette forming equipment hadn't been completed when I visited his facility a few months ago. However, a plan had been set in motion. "I want to install upgrades that would allow the sawdust to automatically reach the machine," he said. "Equipping the hoppers with sensors is also something I am looking at. Eventually, I want to add a stacker, which would automatically stack the bricks when they come off the conveyor. Also, I would then have the bricks travel through a heat tunnel, where they would be wrapped."

Currently, with the absence of such equipment, his mother Edna is required to do a bit more labor-intensive work. "I want to streamline the process as much as I can for her," Mervin explained. "I want this to be her project then. Simplifying the production process of the bricks will eliminate a few extra steps."

Regardless of how many upgrades are conducted, one fact remains. "This machine can only produce so many bricks in one hour. If we receive a lot of orders, we can't just go and speed it up and produce more per hour. It's a process that takes time."

If you are tired of cutting and carrying firewood, perhaps you'll want to give Mervin a call. With the ease of tossing a few bricks into the stove, you just might have more time to sit by the stove in the evening and watch the glowing flames on a cold winter's night.

*Mervin Borotrager owns Borotrager's True Heat. For additional information or to place an order for wood bricks, you may contact him at the following phone number: 608.495.9079. The mailing address is: E3675 State Highway 154 Hillpoint WI 53937.*

Researched, written, and edited by Leroy Martin for the exclusive use of the Plain Communities Business Exchange, LLC.



Bricks are transported along a conveyor, immediately after production.  
Image Credit: Leroy Martin



A bundle of wood bricks at Borotrager's facility.  
Image Credit: Leroy Martin



Borotrager places bricks on a shrink wrapper.  
Image Credit: Leroy Martin



Pallets of bricks await shipment.  
Image Credit: Leroy Martin

# Trace Minerals are Vanishing Fast



AG-USA, Max-Well  
PO Box 73019  
Newnan, GA 30271  
(888) 588-3139  
[www.AG-USA.net](http://www.AG-USA.net)  
[www.Max-Well.net](http://www.Max-Well.net)



Enormous amounts of research have been building for decades showing the connection between trace mineral deficiencies and serious debilitating diseases.

This carries huge implications for our current and long-term well-being. The following facts are stark and real, and beg us to consider carefully how we will respond.

YOU CAN TRACE EVERY SICKNESS, EVERY DISEASE, AND EVERY AILMENT TO A MINERAL DEFICIENCY.<sup>1</sup> - Dr. Linus Pauling, two-time Nobel prize winner

Dr. Pauling also stated: "The lack of minerals is the root of all disease."

Do minerals really play such an important role in our lives? Yes. Since there are over 5,000 clinical studies confirming this, we can only cover the main points of these studies. Please refer to the footnotes for greater detail.

Mineral deficiencies in our diet exist because of mineral deficiencies in farm lands and garden soils.

Since the lack of minerals is linked directly with disease, it makes it paramount to get these minerals back into our diet. The logical place to begin: realizing that the root of the problem is the soil.

Where is The Good Soil?

## 1. TRACE MINERALS HAVE VANISHED FROM OUR SOIL

"At minimum, at least 60 trace minerals have been demonstrated to be vital to health and well-being."<sup>2</sup>

According to the USDA, "In North America, we have seen an average of 85% mineral depletion over the past 100 years, worse than of any other country in the world."

Modern farming practices rely on chemical fertilizers and focus on yields, not nutrition. Chemical fertilizers only replace a

handful of trace minerals. Most trace minerals have gradually disappeared from our soils and foods. We have harvested them away, and over-plowing, massive erosion, stripping of the soil and rain runoff are also to blame.

The United Nations confirms this. "Trace elements are not regularly applied to the soil by the use of the common fertilizers. Their removal from the soil has been going on for centuries without any systematic replacement."<sup>3</sup>

## 2. HOW SICK IS OUR SOIL?

Ninety nine percent of Americans are malnourished. Very few Americans have no health problems. We lack the necessary vitamins, minerals and nutrients in our diet to be healthy. We grew up with these deficiencies, making us vulnerable to cancer, Alzheimer's disease and Parkinson's disease, just to name a few.

In 1936, a U.S. Senate investigation revealed that "foods grown on millions of acres of land no longer contain enough minerals and are starving us"<sup>4</sup>. If this was true when this report was issued, it is even more true today. According to News Canada, over the entire 20<sup>th</sup> century the average mineral content in cabbage, lettuce, spinach and tomatoes, declined from 400 mg to less than 50 mg.



The most startling fact of all is that our main dietary foods, i.e. fruits, vegetables and grains, are being grown on land that is depleted of the essential trace minerals needed to maintain proper health. The result? A vast majority of the American population is starved of minerals. No wonder we are seeing such a large increase in disease. Americans are eating more calories, but getting less nutrients with those calories.

## 3. THE LINK BETWEEN SICK SOIL AND HEALTH

Thirty five million Americans suffer from arthritis because of a lack of zinc and other minerals.<sup>5</sup>

The following quotes, are quite alarming:

- Only 1.5 percent can be considered healthy
- About 9 of 10 suffer from constipation
- About 77 percent of adults are affected by arthritis and rheumatism

Cancer is the number one cause of disease-related death of children (what is this that we are doing to our kids?) "An increasingly large amount of disease today may be attributable to deficiencies in the supply of trace minerals in our diets."<sup>7</sup>

Minerals are essential in the absorption and utilization of many nutrients, and aid enzymes and hormones in activities that are vital to life. Every vitamin keys on a specific mineral to do its work.

New research shows that trace minerals play a vital role in preventing catabolic and debilitating disease. There are dozens of elements/minerals found in nature and needed by our bodies in balanced proportion.

Diet can have a dramatic influence on the prevention and treatment of cancer. The American Medical Association listed poor diet as one of the four key health behaviors significantly related to cancer, heart disease and diabetes.

How do we get these needed minerals back into our diet? HERE IS SOME GOOD NEWS! The ocean contains the perfect proportion of all elemental minerals. Rains have leached these minerals from our soils to the ocean. We simply need to recycle them!

## The Solution Is In The Ocean

While researching root causes of sickness, Dr. Maynard Murray's studies led him to the sea, where he found no trace of cancer, arthritis, or arteriosclerosis, and no aging on a cellular level. He discovered that sea life is nurtured in a balanced solution of all 90 natural elements found on the Periodic Chart of Elements.

In stark contrast, Dr. Murray observed a great deal of disease in land animals. His conclusion? The reason there are diseased animals on land and not in the ocean is because soils are deficient in minerals; the sea is not. Food grown in mineral deficient soil cannot adequately support health.

Dr. Murray research showed when land animals were fed crops that were fertilized with





sea minerals, they were not nearly as susceptible to cancer and other diseases. From his 30 years of research, Dr. Murray concluded that the proportions of trace minerals and elements present in pure seawater are optimum for the growth and health of both land and sea life.



Many of us have spent long hours trying to find an answer to this problem of mineral deficiency that faces our nation and world. It can be pretty overwhelming. The simple and most complete solution is to get what's in the ocean into our soil, into our fruits, vegetables and other crops, and into our bodies!

### Three Great Sea Mineral Options

#### 1. EAT SEAWEED

There is an array of ocean vegetables that are naturally rich in the minerals missing in most of our diets. Ocean seaweeds grow in a perfect mineral rich environment. Seaweeds like kelp, dulse, bladderwrack and nori produce an impressive array of vitamins, enzymes and phytonutrients, and when cooked correctly, can be quite tasty.



Did you know that the Japanese are some of the healthiest people on the planet? They consume about an ounce of seaweed a day. We can learn from them!

Our health is both related to what we eat and what we don't eat. SEA VEGETABLES ARE THE ONLY PLANTS IN THE WORLD THAT POSSESS THE FULL GAMBIT OF MINERALS, TRACE MINERALS, ENZYMES, CO-ENZYMES, VITAMINS, CHLOROPHYLL, GROWTH HORMONES, PHYTONUTRIENTS AND OTHER NEEDED COMPOUNDS.

There is an abundant supply of seaweed. Some sea vegetables grow at a rate of about 2 feet a day. Sea vegetation can withstand heat

This is a Paid Advertisement and needs no refrigeration. It is non-toxic. Eating sea vegetables is a great place to start.

For those who don't like seaweed, our Ocean Treasure supplement contains 9 varieties of red, green and brown seaweeds and powdered sea minerals in capsule form. It is inexpensive (\$16/month) and convenient!

#### 2. TAKE IONIC SEA MINERALS

Cost wise, you can't get more bang for the buck than with liquid Ionic Sea Minerals. One teaspoon a day (just \$5 a month when purchased by the gallon) provides a full spectrum of easily absorbed, low-sodium trace minerals. To avoid the bitter taste, you can get sea mineral powder in capsules.

Ionic Sea Minerals meets some pressing nutritional needs. It contains 106% of the U.S. RDA for magnesium, so is amazing for constipation! Most other mineral supplements are colloidal minerals, which are not readily available to our bodies. Liquid sea minerals are not colloidal, but ionic, and are easily absorbed and utilized. It also works well as a rehydration solution. I sweat a lot when I work or play hard. In the past this led to dehydration and headaches. The headaches completely disappeared in 2006 when I began taking Ionic Sea Minerals!

How does Ionic Sea Minerals compare to sea vegetables?

Ionic Sea Minerals has a much greater concentration of trace minerals than sea vegetables. To get the same amount of trace minerals, you would have to eat a considerable amount of sea vegetables.

However, Ocean Treasure sea vegetables have a whole array of valuable nutrients not contained in Ionic Sea Minerals. They are grown in the perfect mineral solution, and are wonderfully nutritious!

#### 3. EAT FOODS GROWN WITH SEA MINERALS

Each of the solutions above only serve as a temporary fix to get us to the real solution: Farmers and gardeners must start fertilizing with trace minerals. Consumer demand is the only thing that will work to bring this about.

When consumers place enough value on foods rich in trace minerals, they will reward farmers for fertilizing with them. When the demand becomes great enough, we will reach a tipping point, leading to much more nutritious foods.

If you have a garden, MycorrPlus, which contains ocean trace minerals, can greatly improve your soil. Or use ocean trace minerals to directly foliar feed your garden. We sell

both of these, MycorrPlus-A and OF ([www.AG-USA.net](http://www.AG-USA.net)).

You can talk with a local garden co-op and request they fertilize with sea minerals. If you drink raw milk, talk to your supplier about fertilizing their pasture with sea minerals. Restoring demineralized soil back to health is critical for all of us.

According to Dr. John Todd: The fastest and first step to get into soil a complete balanced supply of elemental nutrients for soil microbes, plants and animals is an application of sea minerals. Spreading or spraying a light to moderate load of unrefined sea minerals delivers a fully digested, fully soluble balanced blend of all 90 elements. A dose of sea minerals jump starts biological life cycles and food webs in soil.

So go ahead! Incorporate Sea Minerals into your life.

- Imagine a healthier you, a result of supplementing your diet with sea minerals, seaweeds or crops grown with sea minerals.
- Imagine eating fruits and vegetables from your own garden that contain all these wonderful trace minerals.

#### A WHOLE NEW WORLD AWAITS YOU

Take action now! The window to mineral-rich food, healthy fruits and vegetables and amazing sea mineral supplements is before you. We offer 3 choices:

1. Ocean Treasure, 9 sea vegetables
2. Ionic Sea Minerals
3. MycorrPlus for farm and garden

We have a Max-Well Sampler Pack available for \$52, so you can try Ocean Treasure, SeaBoost Cream for the skin, Ionic Sea Minerals (both liquid and capsules) and SAS, our multi-purpose all-natural soap product. The Sampler Pack also contains our Max-Well information packet, which is chocked full of helpful product details.

Write AG-USA, PO Box 73019, Newnan, GA 30271 or call. (888) 421-5071.

- 1 The Linus Pauling Institute
- 2 Kelly, GS. Sports Nutrition: A Review of Selected Nutritional Supplements For Bodybuilders and Strength Athletes-Alternative Medicine Review – Volume 2, Number 3, May 1997
- 3 The United Nations Food and Agriculture Organization Soils Bulletin No. 17
- 4 U.S. Senate Document 264
- 5 The Survival of Civilization, pg. 104
- 6 The Survival of Civilization, pg. 122
- 7 Medical Nutrition from Marz, 2nd Edition. Omni-Press, 1997. Pps. 103-107
- 8 Sea Energy Agriculture
- 9 Creating World Class Soil, by John Todd, PhD Ocean



# Christmas Specials!

5% OFF by mentioning this ad from December 1 to 10, 2021

**dek** *Spray Master*

**New!** **\$279.<sup>95</sup>**

The *Spray Master* is the first in our new line of **dek Products!**

- Tank Size: 4 gallons
- Extendable Spray Boom: 20" - 40"
- 65 PSI
- Runs off your favorite tool battery



**EZ-360**  
EZ-360-L-30  
**\$117.<sup>90</sup>**  
with 30W bulb

"Hang it up, or set it down!"  
Right-side-up, or up-side-down!"

Available in 5 bulb sizes  
(See rotated position at left.)



**First ever!**  
**EZ-Sew**

**\$439**

Simple-to-use!  
American Home machine!

- Quiet & smooth-running!
- Powered off your favorite tool battery!
- One 5 ah battery should last 1 full day!
- 25-yr limited machine warranty!
- Plus foot pedal & various accessories!

**EZ-Serg available!**



**Ja-SEW-Me** **\$795**

Janome 3160 QDC-T  
**Their 1st 100% DC Sewing Machine!**

Built-in tool battery pack adapter!

- 50+ stitches for the advanced sewist
- Includes foot pedal & other accessories
- Use with Dewalt, Makita, or Milwaukee tool batteries or 12V battery!
- 1-year warranty

**More Efficient!!**



**High-Powered, Cordless DC Blender**

**\$495**

For Blending, Pureeing, Ice Crushing, & more!

- No inverter needed!
- Works with:
  - DeWalt battery
  - Makita battery
  - Milwaukee battery
- 1-year warranty (Battery not included.)

**New!**



**Mini-Power, Han-D-Sew, Han-D-Power I & II** *Very Quiet! Fans run only when necessary!*

Great Power Sources for Electric Sewing Machines & other 110V Compatible Items!

**HDS...\$219.<sup>95</sup>**

- Two 110V outlets
- Two USB ports
- 400W capacity

**HDPI...\$179.<sup>95</sup>**

- For single battery
- No USB ports
- 400W capacity

**HDPII...\$249.<sup>95</sup>**

- Two 110V outlets
- One USB port
- Pure Sine Wave 600W

**Mini Power \$79.<sup>95</sup>**

- One 110V AC outlet
- 150W AC capacity

**All Power Units above include...**

- Battery-level indicator on front panel
- Low-battery disconnect
- Built-in fuse w/overload protection
- Overheat protection
- Sleek, compact design
- Batteries not included



**Cardinal Hello Repair Inc.**

370 Cardinal Drive  
Quarryville, PA 17566  
**(717) 786-3801**

*When ordering items w/batteries, indicate Dewalt, Makita, or Milwaukee! Prices in this ad are subject to change without prior notice.*

**New Prices!**  
1 pair \$49.95 ea.  
2 pairs \$44.95 ea.  
3 or more pairs \$39.95 ea.  
We need shoe sizes, men or women.

**World's Best**

# MASSAGING INSOLES®

BY BESTSOLE INC.

**Feet, Ankles, Knees, Hips, Back...HURT? STOP YOUR PAIN NOW!**  
*A natural approach to health.*

**Why are our Massaging Insoles superior to any other available products at any price?** There is no other product like our MASSAGING INSOLES which incorporates the properties of pure Glycerin with the science of Reflexology to improve your general health. **ACCEPT NO IMITATIONS.** Many companies try to convince that the water, gel, magnets, orthotics, or sponge based products will give you the same results. *This is why we*

**invite comparison.** Bring ANY PRODUCT FROM ANY MANUFACTURER AT ANY PRICE and fairly "walk test" it against our MASSAGING INSOLES. We already know which you will choose within 100 steps.

**How can we be so confident of our MASSAGING INSOLES product?** Our MASSAGING INSOLES help correct and/or treat the problems thus minimizing pain! All our foot problems (and many other spinal column problems) are caused by the fact that we were designed to walk in bare feet on soft ground. "Civilization" has taught us to do exactly the opposite and continually walk on hard surfaces wearing improper footwear for long periods of time, allowing the

foot to lose its natural posture and conditioning. This causes the foot to "settle", which in turn adversely affects the alignment of the feet, legs, and entire spinal column.

**The "Pump" effect is the beginning of your treatment.** Our MASSAGING INSOLES are flexible and "pump" at the arch with every step. This constant "pumping" improves blood flow and stimulates circulation in the **foot and entire body.** Increased circulation helps stop burning

feet, leg cramps and foot swelling. The increased circulation also helps with gout and diabetes by dissolving the pockets of uric acid and crystals which have developed while the blood movement was slower.

**Absorbs Shock.** Our Massaging Insoles can dramatically reduce shock on the lower skeletal system. The PURE glycerin actually "floats the foot", therefore the shock is absorbed by the insole and not the ankles, knees and lower back

**MADE IN THE USA**  
**PFA**  
PODiatric FOOTCARE ASSOCIATION

**The Yoders are official dealers of the MASSAGING INSOLES and can be reached at (740) 887-2431 | 52702 Eagle Mill Road, Londonderry, OH 45647**





# GOD OFFERS YOU THE POWER - FREE

## Dealer/Installers Wanted!

For questions about Off Grid Solar Systems, please give us a call at 574-642-2608

### ENERGY STORAGE SYSTEMS

### UL APPROVED BATTERIES

10 Year Factory Warranty  
Can be Paralleled



- 5KWh 48V
- 7.5KWh 48V
- 10KWh 48V
- 2.5KWh 24V
- 5KWh 24V
- 7.5KWh 24V



### BRAND NEW BREAKTHROUGH PRODUCT

HYBRID ALL-IN-ONE, OFF GRID, PV INVERTER/MPPT CHARGE CONTROLLER WITH AUTO-TRANSFER SWITCH

Can be Paralleled  
Wi-Fi Compatible

- 3kW 24V or 48V
- 6kW 48V
- 12kW 48V

### LITHIUM BATTERY PACKS



Free Shipping  
Great Prices!  
Can be Paralleled  
5 Year Factory Warranty  
6 Weeks Delivery

- 12V 200Ah
- 12V 400Ah
- 24V 200Ah
- 48V 100Ah

At RenuEnerG Components our focus will be on supplying our network of installers with quality renewable energy products.

We will sell to retail customers; however, although we are working on it, presently we do not have the knowledge to answer technical installation questions.

### OFF-GRID INVERTER /CHARGER

From 1.5kW to 15kW  
12V, 24V or 48V DC  
120/240V AC Output  
• 1.5KW • 3KW • 6KW



### MPPT SOLAR CHARGE CONTROLLERS

12V, 24V, 36V, or 48V

- 12V or 24V 20A
- 12V or 24V 40A
- 12V, 24V, 36V, or 48V 30A
- 12V, 24V, 36V, 48V 60A
- 48V 100A



## RenuEnerG Components

10521 County Road 42, Millersburg, IN 46543  
email: [sales@renuenergy.com](mailto:sales@renuenergy.com) | phone: 574-642-2608

## ANNOUNCEMENT

Our prices will need to reflect the rising shipping costs so we are unable to publish them at this time

# TOUGH ENOUGH FOR EVERY JOB



MSRP  
\$499.98-\$569.98



FITS MOST MAJOR BRANDS

GET MORE OUT OF YOUR WALK BEHIND MOWER

- Weight capacity 300 lbs
- Quick disconnect pins
- 12.5 cubic feet capacity
- Wall-mount bracket

#### INDIANA

Borntrager Engine  
Shipshewana, IN - 260-768-3129  
Fry's Repair Shop  
Topeka, IN - 260-593-3228  
G&S Engine Service  
Topeka, IN - 260-593-3983  
Joe's Engine

Breman, IN - 574-546-4413  
Miller Power Enterprises  
Topeka, IN - 260-768-7002  
Miller's Small Engine  
Grabill, IN - 260-385-6595  
Wagler Lawn Equipment  
Washington, IN - 812-254-2446  
County Line Engine

Ligonier, IN - 260-593-2792  
**OHIO**  
Charm Engine  
Millersburg, OH - 330-893-3033  
Hittec  
Adamsville, OH - 740-801-0537  
Precision Power Equipment  
Mt. Eaton, OH - 330-359-0671

Ray's Repair  
Middlefield, OH - 440-834-1107  
Winesburg Lawn & Garden  
Winesburg, OH - 330-359-0330  
New Bedford Engine  
Fresno, OH - 330-897-2190  
Berlin Gravelly  
Millersburg, OH - 330-893-2421

Yoder's Small Engine  
Sugarcreek, OH - 330-852-8040  
Schlabach's Engine Repair  
Millersburg, OH - 330-674-0479  
Holmes Power Equipment  
Millersburg, OH - 330-674-4329  
Schlabach Engine Ltd  
Applecreek, OH - 330-698-0229

#### PENNSYLVANIA

Blue Mountain Small Engine  
Newburg, PA - 717-423-5386  
Redwell Repair  
Gordonville, PA - 717-768-8939  
Esh Sales and Rentals  
Gap, PA - 717-917-3507  
Riehl Equipment

Ickesburg, PA - 717-438-3907  
Ben's Engine Repair  
Fredonia, PA - 724-475-1144  
Honeybrook Hardware  
Honeybrook, PA - 610-273-3724  
**MICHIGAN**  
Mid State Welding  
Rodney, MI - 231-867-2410

BECOME A DEALER • 330-893-3033



**BCS TWO-WHEEL TRACTORS**

**PTO-DRIVEN ATTACHMENTS FOR EVERY SEASON**

**YEAR END SALE!** SALE ENDS 12/31/21  
**SAVE BIG ON SELECT TRACTORS & ATTACHMENTS**

**A K SMALL ENGINE, LLC**  
 15726 HWY C – VERSAILLES, MO 65084  
**CALL FOR A QUOTE TODAY: (573) 378-6339**

**Just Add Wood and You're Ready To Make Money In Firewood!**  
**BRUTE FORCE Gives You Choices Based On Production Needs...** *Invest Less! Produce More!*

**Model 14-24**

- 26.5 HP EFI Kohler
- 18" Cut diameter
- Up to 3 cords per hour

**Model 20-24**

- Model 20-24 Firewood Splitter
- Fastest commercial splitter at the Paul Bynyan Shoot out!
- 19 HP Kohler engine

**Model 24-30HD**  
**For Large Logs & Big Production!**

- 30" diameter cut
- 56 HP Kohler diesel engine
- Up to 6 cords per hour

**Custom color options for all Brute Force equipment**

- Firewood Processors
- Log Splitters
- Firewood Bundlers & Conveyors

**Every BRUTE FORCE Processor comes with our exclusive Round Trough to handle crooked wood with ease!**

**BRUTE FORCE** 715-678-0037  
<https://www.bruteforceusa.com>  
 email: sales@bruteforceusa.com

**Dealerships Available & Rental Opportunities**

**CUSTOM ENGRAVED ALUMINUM CAKE PANS**

**1 pc Cake Pan**  
 6x8 engraving, **\$32.16 each**  
 full engraving, **\$44.16 each**  
 + shipping

**12 pc Cake Pan**  
 6x8 engraving, **\$25.74 each**  
 full engraving, **\$31.33 each**  
 + shipping

*Gifts for... Award - Employee - Wedding - Baby - Housewarming*

**CONTACT US FOR YOUR CUSTOM ENGRAVED NEEDS**  
 GLASS • STAINLESS STEEL • ALUMINUM • POWDER COATED METAL • WOOD

**Homeplace MARKET**

329 Ferguson Rd | Schellsburg, PA 15559  
 Phone: 717.983.8450 | Fax: 717.912.4065  
 sales@homeplacemarket.com  
 ~Wendell Zeiset

**MADE IN AMERICA**

**THE WORLD'S FINEST CUTLERY**

**CUTCO**  
 The World's Finest Cutlery

**BASIC SET** | **FAMILY SET**

**BUSINESS GIFTING SPECIALIST** | **CUTCO ROB**  
**440.463.3856**



**10% OFF Thru December**

**Lakeside illumination**

574-528-0867 14727 S Co. Line Rd. Syracuse IN 46567



**Motion Sensor**

Motion sensor perfect for closet, pantry, entry etc.  
Easy adjustable time on (screw in back)  
1 min to 10 min  
Shown with 15 watt dimmable bulb (sold separately)

**\$145 + 15 shipping**

Makita 5010  
Dewalt 5011  
Mil 5012

**The illuminator**

Powder coated frame  
Lighted switch  
Shown with 15 watt dimmable bulb & shade (sold separately)

**\$72 + \$15 shipping**

Makita 7021  
Dewalt 7022  
Mil 7023



**Wall mount light with remote**

Remote has 150' range  
Shown with shade & 15 watt dimmable bulb  
Bulb & shade sold separately

**\$136 + \$15 shipping**

Makita 9412  
Dewalt 9414  
Mil 9415

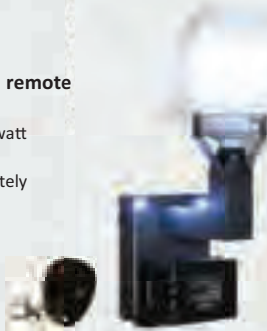

**Now available with night light**

Button 1 activates the main light, button 2 activates the night light

**\$156 + \$15 shipping**

Makita 9422  
Dewalt 9424  
Mil 9425

**IS YOUR COLON CLEAN?**

**POSSIBLE INDICATIONS OF A CLEAN COLON AND BALANCED BODY PH INCLUDE:**

Smooth skin | No need for deodorants | Well-formed stools  
Regular bowel movements | Good digestion | No need for breath mints



AIM  
FiberBlast

AIM COMPANIES HAVE BEEN PROVIDING QUALITY NUTRITIONAL PRODUCTS SINCE 1962.



Also Available in Capsules



**WHAT OUR CUSTOMERS ARE SAYING:**

"Our 20-year-old son needs no reminders to take the FiberBlast. (Such a nice complexion)"

"Our children started passing worms almost immediately."

"We have spent THOUSANDS of dollars on different products, and nothing has ever worked as well as the AIM products."

"Our daughter and her husband had used Para 90 and other FiberBlast. Saliva testing from a Florida lab showed NO parasites. The lab people said that never happens."

**FOR MORE INFO, CONTACT:**

Lydian Miller  
3825 Township Road 368  
Millersburg, OH 44654  
**330.893.8000**

\*Please email, call or text if having a message.  
\*We cannot be held responsible for any adverse effects.  
\*Consult your doctor for any health concerns.

**ARBORIST FLEET PACKAGE**



**Husqvarna**

**\$503.99**  
when you buy any 3 or more  
XP chainsaws  
550xp Husqvarna Chainsaw

**Husqvarna**

**\$823.99**  
when you buy any 3 or more  
XP chainsaws  
572xp Husqvarna Chainsaw



**Husqvarna**

**\$959.99**  
when you buy any 3 or more  
XP chainsaws  
390xp Husqvarna Chainsaw



**372XP CHAIN SAWS  
NOW IN STOCK AGAIN**



**330-359-0671**

PO BOX 337 16146 E. Main St. • Mt. Eaton, OH 44659  
MON.-FRI.6 A.M.-5 P.M. • SATURDAY 7 A.M.-NOON

Quality workmanship since 1999

**Mt Hope Planing  
Custom Millwork**

- S4S • Cut to Size Parts • T&G Table Top Materials
- Paneling • Profiles • Shiplap
- Planing • Ripping • Sanding • Resawing • Moulding
- Circular Saw Cut Textures • Band Saw Cut Textures
- Wire Brushing • Hand Distressing
- Staining and Finishing Available
- Specializing in Character/Rustic Lumber 4/4 - 8/4

Toll Free (888) 549-2524 Fax: (888) 400-6493 mhpsales@plainemails.com

7598 TR 652 | Millersburg, Ohio 44654



## Machining & Welding Services

- CNC Milling
- CAD Drawing/3D Modeling
- Welding
- CNC Turning
- Waterjet Cutting
- Fabrication

Providing integrative services and quality products related to the metal working industry.

### A & A Machine Co.

80 Energy Blvd., Rocky Mount, VA 24151

phone: 540.482.0480 fax: 540.482.0482

## BARGAIN MAX, INC.

DOUG: 704-277-8007  
SALES: 704-612-9794

Specializing in Closeout Merchandise at the Lowest Prices!

### Forehead Thermometers Available

We Warehouse Our Closeouts, That's Why We Can Negotiate The Best Pricing. The Larger The Quantity, The Lower The Price.

purely Elizabeth.

Banana Boxes Available \$500.00 OFF All full truck loads Stock up with Spring...

### Name Brand Gourmet and Specialty Foods

FTL Starting at \$12,000.00 plus shipping Charlotte  
Frozen Loads\*Cheese\*Meat  
"Stock up at these great prices"

Laundry Detergent Liquid or Dry  
Gallon or Totes

FOB LOCATION  
in North Carolina  
Our Warehouse  
Available  
CALL FOR MIN. QUANTITY

Unpack this for your business and  
unpack **PRODUCTIVITY!**

### New! POCKET HOLE MACHINE

- Completely Air Powered
- Single Spindle
- Sioux 1 HP Air Drill
- Foot Pedal Operation
- 1/2" to 1-1/2" Material Capacity
- Leaves Both Hands Free to Handle Stock

**\$1,650.00**

1564 Main St. (Rte 23) Suite 108  
East Earl, PA 17519  
800-445-4669 Fax: 717-445-5875  
conestoga@emyepeople.net

CONESTOGA  
WOODWORKING SUPPLY

## COBLENTZ FOOTWEAR

5949 RT. 83  
CONEWANGO VALLEY, NY 14726

MR. & MRS. LEVI COBLENTZ,  
OWNERS

WRITE FOR A  
FREE CATALOG!

OPEN 8-5 MON.-WED., FRI.-SAT.

MUCK - ROCKY - LOWA  
DRYSHOD-TINCLEY - SBS  
KIPLING - IRISH-SETTER  
BLUNDSTONE - WHITES  
QUATRO - WOLVERINE  
JUSTIN - DURANGO  
CHIPPEWA - BLITZ  
GEORGIA - DANNER  
REED - LACROSSE  
CAROLINA - DREW  
PEACH LANE

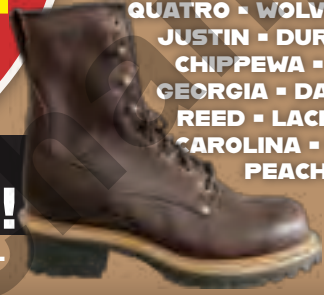

Hey Wait!

CALL ED!

FOR A FREE CATALOG  
with BARGAIN SECTION

Thermal, IR,  
True Night Vision Products

DEALER FOR

- Zeiss • Vortex • Styrka
- GPO • Leupold
- ATN • Pulsar • Sightmark

406.745.5115  
Fax 406.745.6116

ED'S OUTDOOR STORE

32040 Allison Rd. • St. Ignatius, MT 59865

— Ich Kann Deutsch —

## HORNING OUTDOOR FURNACES

THREE SIZES AVAILABLE

- Heavy Duty Firebox
- Built with 3/8" thick plate steel
- Electric or air controls



Farmshop Manufacturing

W 4413 Highway N, Owen, WI 54460 • 715-229-2206

Dealer Inquiries Welcome

Children need your presence  
more than your presents.

Can your cabinets  
deal with **water, mold,**  
or **condensation?**

Try our

**WEATHERPROOF  
POLYMER CABINETS**

Ideal for garages, basements,  
shops, bathrooms, and kitchens

**Heartland**  
POLYMER CABINETS

5175 W 700 S | Topeka, IN 46571  
Voicemail: (260) 593-3101



Looking for dealers to  
sell from our catalog.



# Find KC Innovations this winter:



January 28-29, 2022

Come meet the team at the Midwest Tool Expo at the KC Innovations booth!



February 17-19, 2022

KC Innovations representatives onsite at Airworks and Keim Lumber booths!

## EZ-360 Specials

The wildly popular EZ-360 line is available with multiple switch options.

Features:

- ~Pull chain, remote, timer, and motion sensor
- ~low battery protection
- ~four different options
- ~very portable
- ~black powdercoated frame
- ~Use your favorite tool battery!



## Han-D-Power II

The Han-D-Power II is an all purpose power source made to operate common 110V household items.

Features:

- ~600 watts continuous, 1200 watts surge
- ~Pure sinewave inverter
- ~Two 110V plugs and one USB plug
- ~Easy carry handle makes it very portable
- ~Operates sensitive electronics
- ~Use with Dewalt, Makita, or Milwaukee!



Find a gift for that special person in your life!



**812-636-3684**  
Call for your local dealer  
or a full line catalog!



**Lindenholz  
Blacksmith Shop**

Manufacturers of Axle Clips & Clip Bars

## Axle Clips - Straight & Prebent

Available In  
Stainless Steel

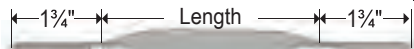
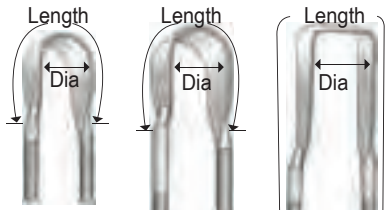

Lengths available: 2" through 7" in 1/2" steps

- Mix or Match
- Free Sample to Buggy Shops
- Square or Hex nuts included

Quantity  
Discounts!

Send for price information

202 Parkview Heights Road • Ephrata, PA 17522

# SAVE UP TO 60% IN ENERGY

WITH OUR TANKLESS  
WATER HEATERS

ORDER TODAY  
330.893.3785



Ignition Control	Model	Fuel	BTU	GPM @ 35* rise	GPM @ 70* rise
2 D Batteries	GA10FLP	Liquid Propane	65,000	3.41	1.83
2 D Batteries	GA10ENG	Natural Gas			
2 D Batteries	GA16OLPDP	Liquid Propane	100,000	4.66	2.50
2 D Batteries	GA16ONGDP	Natural Gas	105,800	4.93	2.65
110 V	GA14CSALP	Liquid Propane	100,000	4.6	2.5
110 V	GA14CSANG	Natural Gas			
110 V	GA20CSALP	Liquid Propane	145,000	6.87	3.8
110 V	GA20CSANG	Natural Gas			
110 V	GA24CSALP	Liquid Propane	170,000	8.34	5.5
110 V	GA24CSANG	Natural Gas			

LOCUST LANE

3939 County Road 135 | Millersburg, OH 44654 | e. evergridsolar@ibyfax.com

# HORSE STALLS



### Sliding Door Options



Wood Bottom

Wood Bottom w/X

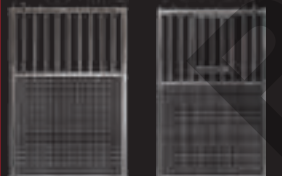

2x2 Mesh Bottom

2x2 Mesh Bottom with Flip Down

### Box Stalls



**TRAIL  
FARM  
SUPPLY**  
330-893-3086  
CALL FOR A CATALOG!

5013 Township Road 359  
Millersburg, Ohio 44654

Richard • Vernon Bontrager  
260.768.7882



4095 N 1000 W Shipshewana, IN 46565  
Fax 260.768.7884



38D (Pony)



DUTCH BOY



4652DBS



30D (Miny Pony)

### CRUISERS

- Durable
- Powdercoated
- Lightweight
- More Seating Capacity
- Short Turn Radius
- Hitches
- Bucket Seats

### OPTIONS

- Hydraulic Brakes
- Cable Brakes
- Headlights
- Marker Lights
- Striplights
- Wheel Sizes
- Vinyl Seat Colors
- Torsion Axles
- Powdercoat Colors
- Hitches
- Custom Sizes
- Aluminum Fenders
- Cup Holders
- Windshields (Removable)
- Poly Cubbyholes

- Whip Holders
- Hold Backs
- Leaf Springs

Heavy Duty Cart Wheels  
1/4 Spokes 5" Hub  
(Super Durable) 3/4" Bearing  
Available in: 20", 24", 26"



PONY CART

DESIGNED TO MEET YOUR TRANSPORTATION NEEDS

### PONY CRUISERS OPTIONS

- Springs
- Light Package
- Marker Lights
- Head Lights
- Strip Lights
- Vinyl Colors
- Dash Covers
- Mud Flaps
- Shaft Brackets
- Aluminum Fenders
- Canvas Tops
- Enclosers
- Hydraulic Brakes
- Buggy Wheels
- Hold Backs
- Flat Free Inserts



# Nighthawk 3D

1735 N 500 W • Shipshewana, IN

**Tired of defrosting your fridge?**



**With NightHawk 3D's Fridge Fan ice build-up is greatly reduced.**

Mounts directly to fins removing the need for frequent defrosting.

Call with your orders today

**260-214-0168**

- Fridge runs more efficiently
- Even temperature throughout
- Keeps ice off fins



12V with Optional Cordless Battery or 110V Adapter

Ask about our custom prototypes and production solutions.

# Specializing in Douglas Fir Timbers and Beams

for Timber Framings and Builders

- Dry Engleman Spruce house logs for Cabins and Log Homes, up to 48 ft. long.
- Aspen poles, logs, slabs, and flat stock for Rustic Log Furniture.
- Custom Cut Lumber
- Wood Barns
- Firewood
- Timber Frame & Trusses
- Log Cabins
- Custom Beams & Vigas up to to 40 ft.



**QUALITY TIMBERS & WOOD PRODUCTS, LLC**

**719-843-0280**  
10725 St. Hwy. 285  
ANTONITO, CO 81120

## GREAT CHRISTMAS GIFTS

**Vita Mix \$528**

**High Speed Blender**

(Air Powered) Model BP45900WA

Great for Beverages, Shakes, Dressings, & more! Has also been used for grinding whole grain.

- Blender Pitcher (virtually unbreakable)
- Air Motor Base
- Cook Book
- Tamper
- DIMENSIONS: 6"D x 8"W x 19"H



**Bender Blender**

Operates on power tool batteries. Dewalt, Milwaukee, or Makita.

**\$195**

Free Shipping on Bender Blender if PrePaid



**Light Box**

(with Pull Cord Switch)

Battery &

Bulb Not Included

**\$82**



**Ninja Blender \$495**

Works great for:

- Milkshakes
- Smoothies
- Chopping Vegetables
- Salsa Making etc.



**No Inverter, Battery Not Included**

Available in DeWalt, Milwaukee, or Makita

**Electric or Air Powered Mixer-Blender Combos!**

**Sunrise Sales**

**765-592-6255**

11187 E Putnam Rd  
Rockville, IN 47872

**\$55<sup>00</sup>**



**LED HEADLAMP**

Model 555-2nd

**Millertech**

**DOUBLE POWER 1800 Lumens**

## 2022 Train Calendars

Makes great Christmas gifts!



#2201



#2202



#2203



#2204



#2205



#2206

Pick your favorite railroad and enjoy them throughout the year.

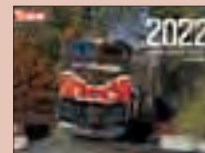

#2211



#2221

Imagine yourself being track side as you enjoy a full year of steam, passenger and freight trains.



#2231 #2232  
36" x 24" | 17" x 11"  
Price is 50% less for 17"x11".

**PRICING (Mix & Match)**

1 pc.....	\$16.95
2-5 pc.....	\$15.95
6-11 pc.....	\$14.95
12+ pc.....	\$12.95
Shipping.....	\$1.00 ea.
Maximum....	\$12.00 shipping

PA Residents add 6% sales tax.

Ask for large volume (25+) or wholesale discount.

Mention code PCBE21 and receive a catalog with your order.

Mail Orders preferred. Orders will be shipped via UPS or USPS. If you desire to pick up your order please notify us in advance.



125 Cedar Hill Road  
Peach Bottom, PA 17563  
Ph: 717-413-8816

# TIMBER WORLD

*The Voice Of Timber Driven Industry*

## WASTE SYSTEMS

CONRAD BATES

**W**

hat do you think of when you think of a sawmill? Do you think of neat packs of lumber leaving on a truck or piles of logs in a logyard? Maybe you think of the sawmill itself and the brand it is. Or maybe you think with pity on the men that are hustling the lumber and timbers onto stacks.

Or you might be one of the few that think first of gigantic piles of slabs and sawdust and bark and chips. Sawdust is a universal product of sawmills. What is done with the slabs varies but usually they end up going through a firewood chop saw, a chipper, or a hog. In this article you will follow me to explore the underside of some successful sawmills.

This is a big subject that is frequently neglected by newcomers to the sawmill world. Even some old hands at the industry largely ignore the byproducts of a sawmill. This is evidenced by the condition of the mill property. I have been to quite a few sawmill auctions, and the majority of them boasted facilities that were surrounded by piles of chips, slabs, bark, sawdust,

and short chunks of log. A few had literally acres of byproducts.

The problem for many people is that dealing with sawdust, bark, and slabs is considered a waste of money, so the least spent dealing with it, the better. Little time is spent developing markets for these products.

Whatever your thoughts are, I can promise you that if you do not put serious thought into your system for dealing with your 'waste' before setting up your mill, you will be in for some unpleasant discoveries.

Taking care of your waste is expensive. Very expensive, actually. The machinery that comes under this category will eat a significant portion of you set-up budget, and your maintenance budget.

---

---

**THE ONLY WAY TO GET THERE IS WITH A PLAN.**

---

---

It is an unfortunate fact that many mills are actually spending more money turning their waste into a marketable product than they are getting for the product. So this is not a matter of making more or less money, it is a matter of trying to minimize your losses. Here are a few pointers on losing less money with your waste.





In the pit at Tusco Hardwoods.  
Image Credit: Conrad Bates



In the pit under Brookside.  
Image Credit: Conrad Bates

First of all make a careful evaluation of whether you are gaining or losing by what you are doing with your sawdust, slabs, and bark. This is not possible to do without a serious effort to do accurate, detailed records of what you are spending on your waste system, how much downtime it is costing you, and then what, if anything, you are actually receiving for your product. Most mills I know are able to deal with their sawdust fairly easily, and a getting decent prices for it. The big headache for most mills is the bark and slabs.

Regardless of what you are doing with your waste, the best way to minimize your losses on it is to do whatever it takes to get it out of the way as quickly and effortlessly as possible. This is what many mill owners balk over, as this will cost you a lot. It will cost you more if you wait till later sometime to do it right. The reason this is of greatest importance is that having an efficient, effortless way of removing your slabs, bark, and sawdust will allow your workers to be more productive, and drastically improve morale with clean, orderly surroundings. I know firsthand the wearing down effect of not having a good waste system or cleanup program. The money spent on fixing this problem will dramatically reduce your losses on your 'trash'.

What if you wouldn't have to have as much waste do deal with? This is the next most important thing to focus on. If you could turn your slabs into boards, wouldn't you do it? So make sure your sawyer isn't throwing away anything useful in his slabs. If he is, you need to start reclaiming your slabs. This is done by stripping up your slabs and running them through a chopsaw, and then a small resaw to make 1/2"x3-1/2" pallet boards, or 1/2"x 5-1/2". This looks like far too much work for many larger mills, but this is a great way to move the needle from the red into the green on your waste.

What does a good waste system look like? To me it looks

*Timber World - Continued on Page 155*



⤴ Sawdust suction in the head throat at Tusco.  
Image Credit: Conrad Bates



⤴ The classic chipper problem at JM.  
Image Credit: Conrad Bates



⤴ The understory at Deer Creek.  
Image Credit: Conrad Bates



⤴ Vibrator under debarker line at JM Wood Products.  
Image Credit: Conrad Bates



⤴ Chipper at K&B.  
Image Credit: Conrad Bates



⤴ Checking the waste at Winesburg Hardwoods.  
Image Credit: Conrad Bates



like getting your mill far enough off the ground, or over a pit, and lots of vibrating conveyor under the machinery. The perfect scenario is to be able to push all the sawdust and pieces on your mill floor over an edge into your vibrator, with all your strips and chunks and slab leftovers falling into a vibrator with no extra help from anyone. At the end of the vibrator is a fines screen, and then a hog or a chipper. After processing through one of these machines, the pulverized remains go up a belt or into a blower to be piled into a large concrete bay to wait loading on an open top van trailer. Some people load chips into closed van trailers with a chip blower, others use some sort of auger loader. But the majority load with a dock and front end loader (see photo from Winesburg).

With a band mill, many sawmillers become concerned with air quality. The cleanest band headrig I have ever seen is at Tusco Hardwoods in Holmes county Ohio. They have a suction pipe under their 8' headrig, and also a suction manifold in the throat of the head (see photo). Yoder Lumber, also in Holmes county, had very good air quality. This was evidently achieved by a row of large fans in the one end of the building to keep a constant flow of clean air.

The pictures I included show a number of two story mills, and a couple with pits (large ones).

If you build a pit, the minimum size should be at least 6' wide and 3' deep. Basically the larger the better. Then you need to put in slides to get as much of the falling trash into the conveyor as possible. In a narrow pit the slides need



Bins and loading dock at Winesburg .

Image Credit: Conrad Bates

---

---

## I KNOW FIRSTHAND THE WEARING DOWN EFFECT OF NOT HAVING A GOOD WASTE SYSTEM OR CLEANUP PROGRAM.

---

---

to be removable to occasionally clean out from around the conveyor.

Why a vibrating conveyor? This is the most durable and trouble free way of conveying waste and feeding a chipper or hog. They are of course much more costly than a belt, but a much better value in the long term.

Check out the jam-up at JM's chipper. This is a normal sight for a chipper, but there are some styles of chippers that really cut down on the frequency of that issue. K&B has a chipper that has a slanted drum instead of a slanted infeed. This allows the chipper anvil to be parallel with the end of the vibrating conveyor, improving feeding and knife life. Stringer chippers also work very well. This has a different knife angle on the drum that pulls the pieces upward in the throat as they are consumed. This also improves the anvil and knife life.

In conclusion, your waste system will play a large part in the long term story of your mill. This could be the problem behind a lot of wasted effort and frustration at your mill. And you might actually find yourself among those whose waste systems are making their payments for them. The only way to get there is with a plan.

---

*Conrad Bates has been a sawyer and grader at Lincoln Co. Hardwoods (south central Kentucky) since 2011. He is also owner of Timber Driven Machine, a small sawmill equipment design and fabrication company. His goal is to provide efficiency education and practical equipment for the plain communities' sawmill industry. If you are wondering how to improve your system, write to him at 7277 E. Hwy 328, Eubank, KY 42567; or call 606-425-2210, or fax 606-303-3631.*

### **ATTENTION SAWMILLERS**

- Are you looking for a Sawmill Consultant to help you identify your mill workflow inefficiencies and create short- and long-term plans to solve them?
- 2&3D CAD, mill layout, New equipment design

Call Conrad for free first call advice and to schedule an appointment.

606-425-2210 or fax 606-303-3631

# Supplying all your plastic product and greenhouse needs



Nestor Hanging Basket  
Brushed White

Bombay Hanging Basket  
Powered Taupe



Wallace Planter  
Lagoon Teal



Estate Tall Square  
Shaded Graystone



Euro Tall Terrazzo  
Black/ Gold Band



Tulip Urn  
Brushed Seascape Gray



Twisted Rattan Round  
Cone Basket



Mixed Rope / Corn Braid  
Square Cone

- ✦ Hanging Baskets
  - ✦ Planters
  - ✦ Press Fit Pots
  - ✦ Flats & Inserts
  - ✦ Nursery Pots
  - ✦ Drippers
  - ✦ Watering Supplies
  - ✦ Greenhouse Parts
  - ✦ Polycarbonate
  - ✦ Plastic
  - ✦ Plant Marvel fertilizer
  - ✦ Berger Potting Soil
- And much more...*

**3% Early order discount**

## ADARIO SALES

Maintenance free - Our specialty

Call for our **2022** catalog  
LTL and UPS shipping

1262 East Adario West Road  
Greenwich, Ohio 44837

**Phone: 419.895.0077 | Fax: 419.895.2302**

**Wholesale - Call or Inquire**

Arlen Mullet  
330-231-2948

Place Wholesale  
Orders Early to  
Avoid Delay

**THE ARCHERY SHOP**

55 North Hanover St.  
Minster, OH 45865  
419-733-8505

**BENTON BOW SHOP**

6745 Twp Rd. 351  
Millersburg, OH 44654

Note: All mail orders, send to Benton Bow Shop  
Free shipping, Ohio residents add 7% tax

**A-A Archery**

8264 Ridge Rd.  
Frederick Town, OH 43019

**MID-OHIO SPORTING GOODS**

8447 Twp Rd. 652  
Millersburg, OH 44654

**BEAR TRAK OUTDOORS**

845 Commerce St.  
Wellsburg, WV 26070  
304-737-8165



# KOZY KOTE

HUNTER'S BODY - TOP KOTE



All Have  
Removable Booties  
and Come with an  
Orange Vest!



**PATTERN**

- TRUE TIMBER - MC2 425.00
- TRUE TIMBER - KANATI 425.00
- GRAY 445.00

**SIZE**

- SMALL UP TO 5'7" OR 140 LBS.
- MEDIUM UP TO 6'1" OR 170 LBS.
- LARGE UP TO 6'1" OR 210 LBS.
- X LARGE UP TO 6'4" OR 240 LBS.

Also Available in Gray  
For Plain People  
No Zippers  
No Hoods



Made in  
USA

**We Ship**



# Ground Hog Cultivators



- ▶ Briggs & Stratton or Honda Engine
- ▶ 5½ Horse Power Engine
- ▶ 6" Steel Track
- ▶ Weight - 175 Pounds
- ▶ Heavy Built Machine

## AB Repair

— GROUND HOG CULTIVATORS —

525 Jacobs Road, Narvon, PA 17555  
for more information phone – 717.768.3883

# DRIVING YOUR LOGISTICS NEEDS

LTL Pallet or Truckload Shipments

## FREE QUOTES

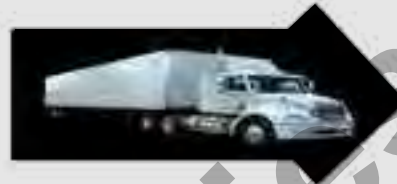

Freight of all kinds moving daily!

## Partial or Full Loads

Throughout the US and Canada

717- 301-4171

calmcompanylogistics@gmail.com

717-385-6242

p1debrab@gmail.com

# Plastic Injection Molding

Custom Packaging

High Volume Production

Custom Colors



Are you frustrated by long lead times and increasing shipping rates from China?  
Give us a call to see how we can help!

Accu-Shape  
**PLASTICS**

555 Amish Rd Gap PA 17527

Phone: 717.405.4689  
Fax: 717.405.4689  
quotes@accushapeplastics.com  
Committed to Quality on time

# Cleanest-Burning & highest-efficiency! Conestoga Champion Furnaces!

No Smoke!  
No Smell! "Not just another FURNACE"



**Top-Loader**  
7-yard wood box

T1-M 1.2M BTU  
T2-M 2.5M BTU

Load at top from a self-dumping hopper.

Tubes don't "soot up"!

**HOOVER Pump Works**

222 Conestoga Creek Rd., Ephrata, PA 17522 • 717-733-0630



**DYMONDBACK \$69.95**  
(Frame & Refill)



**DYMONDBACK REFILL \$44.95**



## CODY JAMES TOOLS

### PREMIUM HOOF RASPS



- \*Lasts 3-6 times longer than other rasps
- \*Saves \$, replace the refill, keep the frame
- \*Won't clog & slow you down
- \*Cuts easily with less effort
- \*Choose fine, medium or aggressive

278 State Route 37  
New Fairfield, CT 06812  
1-203-746-8055 \*shipping \$8



**LITTLEFOOT \$65.95**  
(Frame & Refill)



**LITTLEFOOT REFILL \$39.95**



**END CAP \$6.50**



**WOODEN HANDLE \$5.95**



**PLASTIC HANDLE \$9.95**



# Better Health – Happy You

Are you overweight? Tired of being tired?  
Need a little energy? Need a lift me up?

WE CAN HELP YOU!



Tell pounds to **BUZZ OFF**  
with Purple Tiger!

## JOIN OUR WEIGHT LOSS AND ENERGY PROGRAM

<p><b>Plan 1:</b> 10 to 20 lbs. weight loss and energy plan includes:</p> <p><i>Classic Purple Tiger    Thyroid Complex    Colon Go Daily</i></p> <div style="display: flex; justify-content: space-around;">    </div> <p>Increase energy, Weight loss, Controls appetite    Levels Thyroid, Weight loss    Gut health, Weight loss</p> <p>and day by day plan.... <b>\$84.00</b> Autoship <b>\$116.00</b> Retail</p>	<p><b>Plan 2:</b> 20 to 50 lbs. weight loss and energy plan includes:</p> <p><i>Purple Tiger Gold    Thyroid Complex    Colon Go Daily    Purple Tiger Burn</i></p> <div style="display: flex; justify-content: space-around;">     </div> <p>Increase energy, Weight loss, Controls appetite    Levels Thyroid, Weight loss    Gut health, Weight loss    Burn Calories</p> <p>and day by day plan.... <b>\$118.00</b> Autoship <b>\$166.00</b> Retail</p>	<p>ORDER FROM <b>Joan Farmwald</b> 2229 Johnson Springs Road Munfordville, KY 42765 — Phone Credit Card Orders —</p> <div style="background-color: yellow; padding: 5px; border: 2px solid black; font-weight: bold; color: red;"> <p><b>CALL NOW!</b> <b>270-524-2563</b></p> </div> <p><b>Get Healthy with VistaLife!</b></p> <div style="background-color: red; padding: 5px; border: 2px solid black; font-weight: bold; color: white;"> <p><b>BUY WHOLESALE CALL NOW!</b></p> </div>
---	--	---

<p><b>Plan 3:</b> 50 to 100 lbs. weight loss and energy plan includes:</p> <p><i>Gone Wild    Purple Tiger Burn    Thyroid Complex    Colon Go Daily    Tea Lean</i></p> <div style="display: flex; justify-content: space-around;">      </div> <p>Fat loss, Boost Energy, Controls appetite    Burns Calories    Levels Thyroid, Weight loss    Gut health, Weight loss    Water weight, Appetite, Gut Health</p> <p>and day by day plan.... <b>\$151.00</b> Autoship <b>\$212.00</b> Retail</p>	<p><b>Plan 4:</b> Holiday fat shredder and focus plan includes:</p> <p><i>Roaring CBD    Cheata    Thyroid Complex    Purple Tiger Burn    Colon Go Daily</i></p> <div style="display: flex; justify-content: space-around;">      </div> <p>Fat loss, Boost Energy, Controls appetite    Burns Calories    Levels Thyroid, Weight loss    Gut health, Weight loss    Water weight, Appetite, Gut Health</p> <p>and day by day plan.... <b>\$156.00</b> Autoship <b>\$223.00</b> Retail</p>
--	--



# Volleyball Lights

Price **\$450<sup>00</sup>**

Aluminum construction with stainless hardware

Standard 36" height

Discontinuing these lights until early next year new bulbs will have less glare watch for updates

Standard 2000mAh batteries  
Run on two 9V batteries

Special Order Options

48" instead of 36" add \$25.00

Upgrade to 15,000 lumens add \$100.00

Borntrager Sales  
58585 St Hwy T  
Knox City Mo 63446  
VM (660)-299-2760

# ROSS ENTERPRISES, LLC

**\*ONE DAY CDL TRAINING\***



Come train and get your Class A or B CDL with us in just one day.

We train and test people from all over the United States. *You can come from any state.*

**NICK: 573-682-0030**

Email: [RossEnterprises.MO@gmail.com](mailto:RossEnterprises.MO@gmail.com)

[www.mocdltraining.com](http://www.mocdltraining.com)

25170 Bus Hwy 24

Paris, MO 65275

Across from CO-OP

*The Most Efficient Power Available*



**Heavy Duty DC Motor**



- Very easy to install.
- Very quiet and efficient.
- 1 yr. warranty.
- Can be powered by 12V, 24V, or cordless tool batteries. (DeWalt, Milwaukee, Makita)
- Complete Maytag Kit includes motor, mounting bracket, belt, pulley and switchbox.

### Approximate Run Time

(Run time may vary depending on machine & battery condition)

2-9 A.H. tool batteries, 1 - 1 ½ hr.

2-12 A.H. tool batteries, 1 ½ - 2 hr.

50 A.H. 12V lithium battery, 2 - 3 hr.

2 batteries are not required but will double run time

• 12V lithium and aftermarket tool batteries in stock.



ASK FOR  
FREE BROCHURE  
DEALER  
INQUIRIES  
WELCOME

**KING'S SALES**  
★★★★★ & Service

5466 Seldomridge Rd., New Holland, PA 17557  
717-351-9234 • We Ship Local and Long Distance

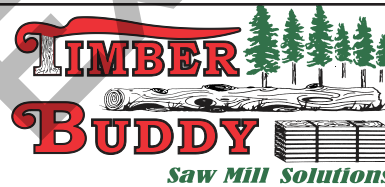

ASK FOR  
YOUR FREE  
BROCHURE

**LOOKING FOR A BETTER SAW MILL?  
WE HAVE YOU COVERED!**



**"We Manufacture"**

- Super Hydraulic & Manual Saw Mills.
- Computer Networks.
- Air Networks.
- Lasers & Mounts
- Upgrade Kits For Other Brand Mills.

**Our Mission:**  
To manufacture better equipment that exceed your expectations without breaking your wallet.

**Customers say:**  
Best Built Mill on  
The Market Today

2529 W Wycoff Rd Ovid, NY 14521  
**Call us today: 607-882-3010**

# The Perfect Gifts

FOR ALL YOUR EMPLOYEES AND CLIENTS

Products and supplies may be limited this year. Place your order now for the best selection.



Meat Lover's Basket  
Basket \$42 Box \$38



Rustic Pines Tray  
Tray \$33 Box \$30



Holiday Farmer's Basket  
Basket \$64 Box \$58



Large Christmas Tin  
\$125



225 Voganville Rd,  
New Holland PA 17557

DELIVERY AVAILABLE  
WE SHIP ANYWHERE  
IN THE USA

PH 717-661-7655  
FAX 717-661-7939



## INTERSTATE FLEET SERVICES

1125 Strickler Road, Mt. Joy, PA

### Vehicle and Equipment Leasing Services

Established in 1953, Interstate Fleet Services is a family owned leasing company that serves the vehicle and equipment needs of a wide variety of businesses. We respond quickly and can tailor any lease to fit your needs.

We serve a large Amish and Mennonite customer base in multiple states from our Mt. Joy, PA location in Lancaster County.

Interstate also offers fleet maintenance at our new 12 bay service center in Mt. Joy, PA. Free pick up and delivery is included.



Additional services we can provide are used vehicle sales and leasing, vehicle upfitting and graphics

Please contact  
Steve Frey with inquiries at  
**215-237-1961**



WE SHIP ANYWHERE IN THE US!   
PROPANE TANK REFILLS



**BAGGED SHAVINGS**  
50 LB. BAG

**FLAX BEDDING**  
40 LB. BAG  
MANY FARM ANIMALS  
LOVE OUR FLAX BEDDING  
Such as Horses, Dogs, Poultry  
Goats & Cattle, Dust Free!

- Decks & Porch Railings
- Picket & Privacy Fence
- Picnic Tables
- Arbors
- Park Benches
- Dog Kennels
- Hotbeds
- Stock all kinds of farm fence supplies
- On Guard Stain

  
**MAPLE VALLEY FENCE LLC**  
Your One-Stop Fence Solution



P. 330-897-7603 • maplevalleyfence.com  
2447 TR 183 • Baltic, OH 43804 • Mon - Fri 7:00am - 4:30pm • Sat: 7:30am - 11:30am



# Heavy Duty Stainless Steel Swivel

AVAILABLE  
IN 316L OR 304  
STAINLESS  
STEEL

**E & B  
ENTERPRISES**

ATTRACTIVE  
QUALITY  
PRODUCTS

## MANUFACTURER OF GLIDER HANGERS

Available in:

- Stainless Steel
- Powder Coated
- Zinc Plated



We also manufacture

## CORNER BRACKETS



Call us for all your custom steel forming needs.

**E & B  
ENTERPRISES**

Owner: Ervin Miller — 17747 LeRoy Road, LeRoy, MI 49655 • Ph: 231-768-5072 • 866-643-5271



The all stainless steel swivel utilizing a completely revolutionary spindle concept.

## SMOOTHEST SWIVEL ACTION EVER, GUARANTEED

- Super heavy duty 1/4" stainless plate
- High-precision, heavy duty ball bearings
- Totally enclosed, sealed center hub, impervious to sand, dust, and other contamination

### SPECIFICATIONS:

- SIZE: 7" X 7" SQUARE
- MOUNTING HEIGHT 1"
- OVERALL HEIGHT 2-3/8"
- PLATE THICKNESS 1/4"
- 5-1/2" X 5-1/2" X 5/16"
- SLOTTED BOLT PATTERN

Available  
in 316L or 304  
Stainless Steel

TRY ONE TODAY

## Built to Last. Built in America.



Built by talented individuals like you. We strive to Produce Quality USA built Postdrivers. that work as hard as you do



CALL us to learn more!

**LAWSEN  
EQUIPMENT**

640 Baseline Rd E, Shiloh, OH 44878 • 419-752-0203

# NOTICE

**CBD oil for sale** in gallon containers for horses or any animals. This hemp is raised in Kansas. This is a proven product and is sent by great volumes to the United Kingdom for their horses.

It has improved:

- eyesight
- skin condition
- stress
- anxiety
- calms nervous system
- hair coat
- hoof
- gut health
- digestive system
- inflammation from arthritis or injury

we also carry  
1oz bottles for  
human consumption

An overall healthy animal.

**Ingredients:** Wheat germ oil, a natural source of vitamin E & full spectrum Hemp extract-less than 0.3% THC. 150 mg per oz.

**Recommended use:** 1 oz. per 1, 000lb.

- Pricing:** — \$280.00 per gallon  
— \$360.00 per gallon (double strength gallon size, 300ppm)  
— Case prices, 4 gallons per case

## Rocky Meadow Equine

4595E 800N, Howe, IN 46746 • 1-838-218-8576



### BUILDING PRICE LIST

20x30x12 .....	\$2,900	50x100x23 .....	\$25,500
24x40x13 .....	\$4,200	50x150x23 .....	\$34,500
30x40x15 .....	\$5,900	50x200x23 .....	\$47,500
30x65x15 .....	\$7,400	60x80x25 .....	\$26,000
30x85x15 .....	\$8,700	60x100x25 .....	\$32,000
40x60x21 .....	\$13,000	60x120x25 .....	\$36,000
40x80x21 .....	\$15,500	60x150x25 .....	\$44,000
40x100x21 .....	\$19,000	70x100x28 .....	\$42,000
40x120x21 .....	\$24,500	70x120x28 .....	\$48,000
40x150x21 .....	\$28,000	70x150x28 .....	\$57,000
50x60x23 .....	\$17,500	70x200x28 .....	\$74,000
50x80x23 .....	\$22,500		

Also available: replacement covers for any brand.  
Any size 12–100 feet wide, any length available.  
Any questions call: **814-233-1050**

## Clothespin Dryers

Wholesale Orders Welcome  
We now have Wholesale Pricing  
for Polypins

Great  
Christmas And  
Wedding  
Gifts



Ask for  
Flyers.

Octagon 43 Clothespins: *Wooden* – \$42<sup>00</sup> | *Polygrip* – \$65<sup>00</sup>

#1 68 Clothespins 22 x 24 ..... \$45<sup>00</sup> wooden ..... \$75<sup>00</sup> polygrip

#2 46 Clothespins 12 x 22 ..... \$43<sup>00</sup> wooden ..... \$62<sup>00</sup> polygrip

#3 38 Clothespins 14 x 18 ..... \$41<sup>00</sup> wooden ..... \$58<sup>00</sup> polygrip

24 Count Packs: 1 to 5 packs – \$15<sup>00</sup> each pack

24 Count Packs: 6 to 10 packs – \$14<sup>00</sup> each pack

Polygrip Clothespins: Clay, Weathered Gray, Green, Pink or Blue – 100 ct – \$65<sup>00</sup> | 24 ct – \$15<sup>00</sup>

### FAMILY CREATIONS

Plus Tax and Shipping

Beth Yoder – 10695 Schow Road, Holton, Michigan 49425

phone: 231-821-2232 • fax: 231-821-2236

## Safe and Efficient Custom Burners

- Technical expertise and a vast array of parts.
- Burners and controls designed for your unique heating project.
- From stainless steel cookers to smokehouse burners, to any industrial project.

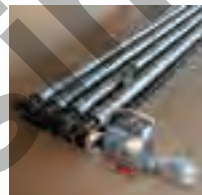
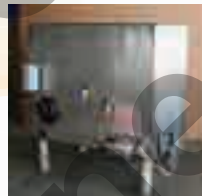

Call us at **Blu Flame Heaters** today!

**BLU FLAME HEATERS, LLC**

(610) 593-0337

1634 Valley Rd.  
Christiana, PA 17509

## DUMPSTERS AND SNOWPLOWS



Self Dumping Hoppers    Open End Dumping Hopper    Quick-Attach Dumpsters



Forklift Mounted Scoop Dumper with Cutting Edge

Snow Plows for: Forklifts, Tractors and Skidsteers



717.355.2008

Well built products that meet a variety of customer needs and do their job well!

CALL TODAY FOR A FREE CATALOG

137 Meadow Creek Road, New Holland, PA 17557



IT FEELS GOOD TO FEEL GOOD! HEALTH IS IMPORTANT,  
LIFE IS SHORT, LETS GET TO THE BOTTOM OF IT!

**ARE YOU FACING THINGS LIKE:**

- Headaches
- Fatigue
- Heart Palpation
- Infertility
- Hysterectomy
- Achy Muscles and Joints
- Acid Reflux
- Neurodegeneration
- Menopause
- PMS
- Covid Concerns

- Anxiety
- Depression
- Insomnia
- Acne
- Brain Fog

Mention the Ad and receive a **\$200** discount on the program price

This is your body's alarm sounding. Lets sit down and find the personal plan that works for you.

Through hair, tissue, urine, saliva analysis, and blood tests we evaluate and help balance your minerals. With mother natures help, we help the body help itself.

**Health Hope**  
SPECIALIZES IN  
THE ROOT CAUSE PROTOCOL

**Health 4 Hope - Jane Martin**  
180 Yummerdall Road  
Lititz, PA 17543  
717-466-2853



# BANDSAW PARTS

manufactured by Weaver Machine & Hardware LLC



**Roller Guides**  
CNC machined and specially hardened with greasable bearings. All popular sizes in stock.

**Roller Guide Shafts**  
3/4" round shaft with flat for clamping or 1/4" square shaft.

**Vee Groove Rollers**  
4" diameter with sealed double ball bearings to easily carry 2000 lbs.

Please call for special pricing and quantity discounts.  
Ask for a free catalog. We ship UPS daily.



**385 Reading Road, East Earl, PA 17519**  
**717-445-9927** - weavermachineandhardware.com

Don't see your part here? We will be happy to custom make your part for you. Your satisfaction is our goal!

## WANT TO...

- STREAMLINE YOUR PAPERWORK?
- CREATE YOUR OWN FINANCIAL STATEMENTS?
- CUT YOUR BOOKKEEPING TIME IN HALF?

**ONE WRITES**  
BOOK KEEPING MADE EASY



Still Licking ONE-WRITE ENVELOPES?



NOW AVAILABLE IN **SELF-SEAL**

**INDIAN TRAIL**  
TAX PREP

**SHARP**

**CASH REGISTERS**



1545 W 450 N, Howe, IN 46746  
260-562-2241 ext. 2  
fax: 260-562-2242

"Bookkeeping Solutions for Plain Businesses!"



**STOLL**  
STEEL BUILDINGS



509 South East Street,  
Odon, Indiana 47562

Call:  
812-687-7440  
for more information

### ADVANTAGES OF STEEL BUILDINGS

- Bigger
- Better
- Low Maintenance
- Will hold its value longer
- Better Value – Bigger bang for your buck
- More durable
- More permanent
- Will last longer
- Stronger

We have a variety of options to fit your custom needs and specifications. Providing a wide range of styles and sizes, we work hard to ensure that you receive the best care and support before, during, and after you have a completed building. Furthermore, our buildings are built to withstand the test of time. Using high-quality steel and talented fabricators, you can be confident that your building will be built to last. We are excited to design, manufacture, and deliver a building that will hopefully surpass your expectations.



10 x 96" fold down shelf 42" railing height.

Scaffolding is 17" high when the railing is folded down.



10" x 69" fold down shelf 6' end sections can be detached from 8' center section. Heavy duty versatile 20' bi-fold scaffold with fold-down railing.



Heavy duty walk plank with fold down railing and shelf. Weighs approximately 750 lbs.

Either 6' section can be detached by removing 2 pins. Fork pockets are also on both ends of 8' long or 14' long can be picked up on either end.



**DALAM WELDING**  
7655 S 200 W TOPEKA, IN 46571

**Specializing in  
Aluminum Fabrication**

260-593-0168 x 1

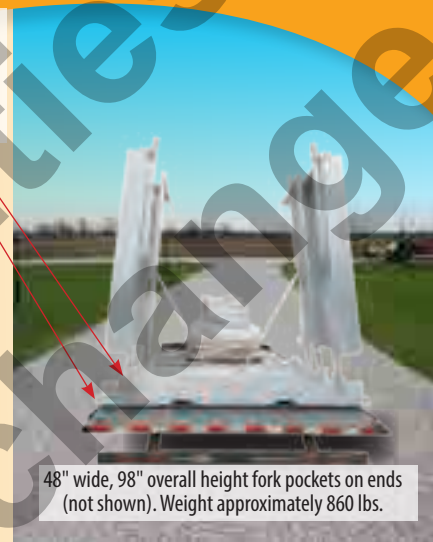

Hinge pins.  
Hooks for safety chains.

48" wide, 98" overall height fork pockets on ends (not shown). Weight approximately 860 lbs.



# Glenn Financial

**Todd Glenn, CFCA®**

Member of: National Association of Christian Financial Consultants



## The Reason for our Logo.

"Why the shield and swords in your logo? I thought you were non-resistant." We wanted a logo that represented the mission that we have for Glenn Financial.

Friend, we are in a spiritual warfare. Unfortunately, most Christians don't think of spiritual warfare in regards to their finances/investments.

After giving it considerable thought, we chose a shield and swords to represent our company. We need the shield of faith (trusting that God's ways are the best ways, regardless of what the world would try to make us believe), and the sword of the Spirit (the sword is both a defensive and offensive weapon—we are told to defend ourselves from the onslaughts of the devil, as well as to fight for Godliness).

Our mission, at Glenn Financial, is to honor God by helping individuals realize a greater purpose in their finances through the alignment of their investments with their individual values, principles, and personal beliefs as we strive to provide uncompromising excellence in portfolio management.

We apply this concept of spiritual warfare to the temptations and the erosion of our moral culture, that we are bombarded with each day. i.e. Pornography in the bookstores/internet/ advertisements, abortion that is killing millions of babies, and the almost compulsory acceptance of the LGBT ideology.

It is not hard to find Christians that will take up the fight for these moral issues. Many will march on Washington, D.C. during the March for Life event. Many will picket the adult bookstore and/or write to the city councilmen to influence them to shut down sexually oriented bookstores (SOBs). We routinely hear messages bemoaning the moral decay of our society.

But, ..... we divorce our finances and investments from the fight. Why?

Let's look at some statistics. Christians are not the only folks that claim to uphold the moral values outlined in the Bible, but even if Christians were the only ones to object to the immoral activities that are so rampant in the US, that would account for 70.6% of the population.

If 70.6% of the US population stood up for moral values, instead of only saying that they stand up for moral values, think of the changes that could be made.

One way to stand and fight for those values that we say we want, is to divest our money from companies that are supporting immoral activities, and to invest only in companies that are profiting from and supporting moral activities.

What would happen if 70.6% of the population would pull their money out of companies that support Planned Parenthood? Or pull their money out of companies that are contributing to the LGBT movement? The list could go on. I think we would see an **immediate reformation** in our corporate world.

Unfortunately, most advisors (even Christian advisors) have not been concerned about the companies in which they have invested your money. You may have even asked them to put your money into 'clean' mutual funds. 'Clean' mutual funds have historically meant that the fund managers have screened out companies that are involved in alcohol, tobacco, and gambling ("Social sins"). Most of these same funds are not screening for abortion, pornography, or alternative lifestyles ("Moral sins"). This is like closing the screen door on the front of the house to keep out the mosquitoes while allowing the elephants to come in the back door.

Even Faith-based mutual funds, for the most part, are not screening for the immoral activities. If you currently own faith-based mutual funds, you may be surprised to discover the companies in which you have your money invested.

There are investment options available that are **truly morally responsible**.

**Will you join us in our fight against the moral decay that is so prevalent in our society today?**

If you do not know into what your money is invested, and you would like to know, please **call Glenn Financial and ask for a free Moral Audit Report of your portfolio.**

At Glenn Financial, we help our clients align their investment portfolios with their Biblical moral values.

3955 Singers Glen Road Harrisonburg, VA 22802 | Phone: 540-820-8633 Fax: 540-867-5702

[www.biblicallyresponsibleinvestments.com](http://www.biblicallyresponsibleinvestments.com)

[www.facebook.com/MoralInvestments/](https://www.facebook.com/MoralInvestments/)

Advisory services provided through Creative Financial Designs, Inc., a Registered Investment Adviser. Securities are offered through cfd Investments, Inc. a Registered Broker/Dealer Member FINRA/SIPC. Glenn Financial Services is not associated with the CFD companies.



# CUSTOM METAL FABRICATING

FAST - ACCURATE - RELIABLE

## CNC 5'x12' Punching / Shearing System

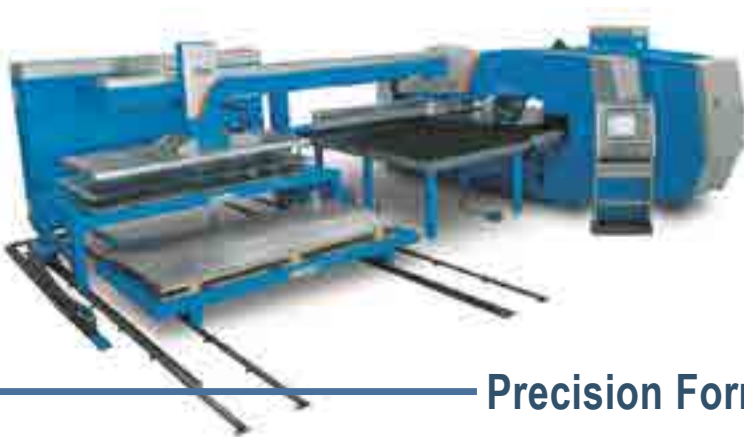

**PUNCH  
SHEAR  
FORM  
NOTCH  
THREAD**



## Precision Forming & Laser Cutting Capabilities

*Aluminum - Steel - Galvanized - Stainless Steel - Copper*

Successfully applying manufacturing solutions to the fabricated metals industry, using state of the art equipment, since 1971.

 **Raytec Fabricating**

New Holland, PA  
www.raytecllc.com

(877) 800-3340  
fab@raytecllc.com



**WeCare Clinic is growing rapidly!** WeCare Clinic has had over 430 patient encounters and 200 active patients seeking care at the clinic in the first year of operation. **WeCare Clinic medical staff are providing care for patients in Kentucky, Tennessee, Iowa, and North Carolina.** With the growth of patients, additional staff are needed to provide the much-needed specialty care for children and adults with rare genetic disorders. **WeCare Clinic is in need of additional financial support as the clinic is growing. We ask that you please consider a donation to the clinic.**

WeCare Clinic is modeled after seven other non-profit genetic medical clinics listed below:

- Clinic for Special Children, Strasburg PA
- Central PA Clinic, Belleville PA
- DDC Clinic, Middlefield OH
- New Leaf Center, Mt. Eaton OH
- Community Health Center, Topeka IN
- Center for Special Children, La Farge WI
- Nemours® duPont Pediatrics – Dover Kinder Clinic, Dover DE

Donations make the work of these clinics possible. Please consider a new tax-deductible donation to WeCare Clinic.

**WeCare Clinic Mission Statement:** "To improve the quality of life for families with genetic disorders through medical care, education, and research."

Make your check payable to: **WeCare Clinic**

Mail to: **WeCare Clinic, 775 Pembroke Fairview Rd, Pembroke KY 42266**

*If you do not wish to send donations directly to WeCare Clinic, anonymous contributions may be made through the Anabaptist Foundation. Make your check payable to the Anabaptist Foundation with WeCare Clinic on the memo line.*

Mail to: **Anabaptist Foundation, 55 Whisper Creek Drive, Lewisburg, PA 17837.**

*For any questions, please call 270-962-7383 or 270-886-5254*

# Why I am Unashamed of the *Christmas Tradition*

ANTHONY HESS

Believers occasionally promote the idea that celebrating Christmas is a carnal activity because the holiday has pagan roots and practices. These practices, they say, were adopted by the Roman Catholic church as it was adapting itself to the world. Some Christians reject the Christmas holiday on the grounds that it is a man-made tradition and not Biblically supported. While this approach may sound strong and pure, I question both the reasoning and assumptions this is built on.

The Christmas tradition, along with other traditions such as Lent, begin their strongest appearances in the 4<sup>th</sup> century. When I use the word “tradition,” I am defining it as a practice that is designed and promoted for the common good of a culture. I would propose that good tradition is not yesterday’s fashion. A fashion is a practice that is promoted for competitive personal advantage. A tradition can be new, and a fashion can be old. A culture can be a confusing mixture of tradition and fashion. The Pharisees used traditions for personal competitive advantage and were actually involved in a culture of fashion by these definitions.

As Anabaptists, we usually accept that the church became heavily tied in with the Roman Empire by the time of Constantine in 300 A.D. We generally reject many influences, customs, and traditions from the 4<sup>th</sup> century and later as being either Roman Catholic or pagan.

While this position gives a form of clarity and relief, it also brings with it some inconsistencies, if we’re honest. One example would be that the church decided to canonize the Bible in the 4<sup>th</sup> century. Even though you could argue that they simply affirmed what was already true, there was no edict given by the apostles or disciples or New Testament

writers that such a thing needed to happen. We accept the 4<sup>th</sup> century’s canonization of our Bible.

I believe Christians are called to build and engage in good works that honor Christ. It is on this premise that I accept much of the Christmas tradition. Read St John 14:12.

If a building leans inward as it rises up from the foundation, moisture and rot invade the building. If a building leans out too far as it rises from the foundation, it will collapse under its own weight. As image bearers of God, we are called to build, create, and reflect our Creator. It is essential that we build our choices and form culture in a way that is square and vertical with the foundation which is Jesus Christ. Read 1 Corinthians 3:10-23. Many things that have been given us by the historic church have been built from gold and precious jewels and other things have been hay, wood, and stubble as this scripture describes. Church history is inconveniently messy.

As Bible-believing people, we accept that the Holy Scriptures are the final authority on whether practices are God

I think believers need to regard both in high esteem when interpreting scripture.

honoring or dishonoring. We depend on the Holy Spirit to guide this process both individually

and collectively. We also rely heavily on the historic and gathered church to help us understand the Scriptures. By historical church, I refer to the church of history made up of people who have passed on. The gathered church is the group of believers that we gather with to worship and counsel, whether that be our conference or our congregation. I think believers need to regard both in high esteem when interpreting scripture.

I think most of my readers will agree that there are many



aspects of the modern-day Christmas holiday that are unprofitable at best and idolatrous at worst. No doubt some of these are unhealthy carry-overs from pagan celebrations.

However, as Christians we enjoy and share many things with the general population around us, not because we share in their paganism but because we share in their humanity.

It is human to enjoy gifts, warm colors, candlelight,

fireside, and greenery inside the house in the cold wintertime. I believe it is pagan to bow down and worship a tree. But the One who created trees that stay green all winter is neither human nor pagan, but divine. What practices can be redeemed and what customs should be discarded is beyond the scope of this article, but Christians do both. For example, most of us use beautiful folk tunes that have been adapted to hymns. Folk tunes often carry rich human emotions that adapt well to Christian themes. Other secular music carries a variety of sensual emotions that we wouldn't want Christian words adapted to.

Some of our deepest and most eloquent Christian theology is found in our Christmas hymns. It is nothing less of a miracle and wonder to me that these majestic hymns are still loved and listened to by believers and unbelievers alike. It can be easy to see the world around us as becoming less and less Christian and thus we associate the modern Christmas celebration as a modern corruption. However, we must remember that since the time of Christ, world history has been dominated time and again by nations that were utterly heathen. Vikings and Mongolians are just a few examples of people groups who dominated the world with pillage, torture, human trafficking, and slaughter since the Advent of Christ. The fact that during the past 20 centuries of church history, these amazing carols have been written

and the advent of Christ is celebrated all over the world today seems like evidence of the expansion of Christ's kingdom rather than an extra-biblical tradition that needs discarded.

It is possible that I justify my appreciation for Christmas because of emotional attachment to the holiday and my memories of it. I will readily admit that I do have an emotional attachment to the

It seems like believers who are trying to live apart from nominal Christianity often have a tendency to promote churches and cultures that have little or no attachment to history, tradition, and celebration. I believe this creates a thinner sense of identity, meaning, and belonging that trends towards instability...

Christmas holiday. On the other hand, it seems like believers who are trying to live apart from nominal Christianity often have a tendency to promote churches and cultures that have little or no attachment to history, tradition, and celebration. I believe this creates a thinner sense of identity, meaning, and belonging that trends towards instability and transience in multi-generational Christian faith and practice.

A concern often raised by Christians is that a conservative expression of a worldly holiday is just a way of doing what the world does in a lesser form. I do agree that holiday festivities and decorations quickly become excessive. But consider this quote from G. K. Chesterton who said, "Joy is the small publicity of the pagan and the gigantic secret of the Christian." Hopefully, inside your home on Christmas Eve, there is a far greater celebration than what the world around you knows anything about. I doubt that my father, or my father's father, or his father knew much about any of the pagan practices connected to some of the Christmas traditions. Our experience of that holiday was greater than any historic abuses we were unaware of.

For myself as a boy, Christmas was a time when schools closed, businesses slowed down, and the family came home. Christmas was a time when we knocked on our neighbors'

*Christmas Tradition - Continued on Page 168*

*Christmas Tradition - Continued from Page 167*

doors and took them pastries and sang them carols. Christmas was a time when they brought gifts, carols, and good will to us as well. Christmas was a time in winter when the days were short and the nights were long, but the fireside was bright and warm and so was the laughter.

I realize that some believers grew up in a culture of materialism and they associate Christmas with our modern era of excess and banal focus on perishable things. Understandably for them, the Christmas holiday does not bring sweet memories. The strong commercialization of Christmas is wearisome to many and is driven by retailers vying for market share as much as anything. However, gift giving often involves both the element of anticipation and surprise. The arrival of the Messiah truly came as a gift.

Something that concerned Christians often point out about Christmas is that we are commanded to celebrate Christ's death but there is no command to celebrate his birth. True. But notice! There are no less than six emotional outbursts regarding the Advent of Christ in the Gospels. Mary, Elisabeth, John, Simeon, Anna, and the wise men all responded to the Advent of Christ with explosive love or praise, not dutiful gravity. God was very pleased when David desired to build Him a house, without God's request. Yes, that temple was corrupted many times. Likewise, the shrines,

There is a strong correlation between the manger and the cross. In both circumstances, God revealed His power in a way that the rulers of this world do not choose to display their power.

images, and art in the modern Catholic Church are usually repulsive to those of us that are Anabaptists. However, the prolific artwork by Christians in the catacombs, under the heavy hand of Rome, speaks volumes.

It tells us that the early Christians under persecution were not austere. As you go into the stores this year, you can shake your head and get all upset by Santa Claus and Christmas lights. I

don't expect anything different of the world around me, but I am absolutely thrilled that the strains of "Joy to the World" can occasionally be heard at a hectic place like Wal-Mart.

Some Christians have pointed out that the manger doesn't offend us but the cross does. Actually, there is a strong correlation between the manger and the cross. In both circumstances, God revealed His power in a way that the rulers of this world do not choose to display their power. The story of Christ from beginning to end is meant to break past our hardened hearts and reveal to us a God who is utterly unlike the rulers of this world and the powers of darkness.

I do not think we need to apologize for celebrating Christmas. May your Christmas be blessed and bright this year as well!

*Anthony Hess lives in Idaho with his wife and 9 children where he operates a sawmill and furniture business for a livelihood. They are members of a German Baptist Brethren congregation.*

*Behold, a virgin shall be with child,  
and shall bring forth a son, and they  
shall call his name Emmanuel, which  
being interpreted is, God with us.*

*Matthew 1:23*







# BEVANDA CUSTOMS

This Christmas Give the  
Gift of Custom



Verge Lunchbox  
A Bevanda Bestseller



Drinkware



Coolers

Call: 717-687-7436

Email: [info@bevandaproducts.com](mailto:info@bevandaproducts.com)

Website: [www.bevandaproducts.com](http://www.bevandaproducts.com)

Visit: 48 Queen Rd. Gordonville PA 17529, Suite 2



Agricultural · Industrial · Commercial

# Signature TARP

Cover Your Investment

11 COLORS TO CHOOSE FROM *Fire Retardant Material in Select Colors.*

## MANUFACTURERS OF *Tension Fabric Building Covers*

- Mono Covers · Keder Panels · End Panels · Gather Doors
- Hay Tarps · Pond Liners · Disc Bine Covers

3433 White Hall Road  
Mackville, KY 40040  
Fax: 859-375-5269

**859-375-5268**

**HARDWARE**

- 1" Ratchets
- 2" Ratchets
- Lashing Winches
- 1" Ratchets with  
6' & 8' Straps



All covers have 2" welds for

**STRONG WATERPROOF SEAMS**



**RROWHEAD MANUFACTURING** Your Custom Equipment Solution  
7961 CR 201, Fredericksburg, OH 44627  
4 miles West of Mt. Hope, Ohio

*Put Your Ideas To Work*

Increase production and quality with custom built machine to fit your production line

Automation saves time ½ hour per day = 125 hours per year 50 pieces per day = 12,500 pieces per year

**Wood Working – Sawmill – Pallet Shop – Metal Working – Equipment**

**Equipment we produced**

- Pallet corner rounder
- Laminated post nailer
- Finger jointer with power feed
- Chair presses
- Automatic stackers
- Belt conveyers
- Edging shears
- Multi head drilling units.

We engineer and Manufacture any type of equipment, products and parts from:

- Steel
- Aluminum
- Tool Steel
- Stainless Steel
- Plastics
- Pneumatic
- Electric
- Hydraulic
- Lineshaft
- Hand powered
- PCL operated

**CUSTOM METAL FABRICATION**

**CONESTOGA WOODWORKING SUPPLY**

YOUR source for **WOODWORKING SUPPLIES** **HARDWARE** and **MACHINERY**

If it's **WOODWORKING Supplies, Hardware, or Machinery** we most likely have it!

Request **YOUR CATALOG** today!

**FREE Catalog**

1564 Main St. (Rte 23) Suite 108  
East Earl, PA 17519  
Fax: 717-445-5875  
conestoga@emypeople.net

800-445-4669

**NO MORE WORRIES**  
Get up to 6850 BTUs at the push of a button!

**MAGMA HEAT**

will keep the air circulated and warm, with forced heat, from a directional vent on the floor. Heater bolts to the floor of your buggy and with a few simple hookups it is ready to use. Runs on mineral spirits or lamp oil and a 12 volt power supply.

Price **\$395.00**

**MAGMA HEAT**  
11090 W 300 S,  
Shipshewana IN 46565  
**1-260-593-0591**

**BOWMANSVILLE COACH SHOP**  
210 Laurel Road, East Earl PA 17519  
**717-445-9963**  
Shipping \$15.00 We accept Credit Cards

Contact Dealer Nearest to You Wholesale Inquiries Welcome

**STAINLESS STEEL SWIVEL**

**FOR HEAVY OUTDOOR USE**  
See our full line of swivels!

10% Discount on First Purchase when you mention this Code: PC314

**FAULL & SON**  
515 Holford Avenue, Niles, OH 44446  
**330.652.4341 • www.faullandson.com**

PC314





**WHICH AIR  
WOULD YOU PREFER TO  
BREATHE?  
STALE, INDOOR AIR...  
OR  
CLEAN, FRESH AIR**

**THE TRIAD AER TECHNOLOGY HELPS  
REDUCE OR ELIMINATE:**

- Allergens (Pet Dander Dust & Pollen)
- Dust Mites/Dust Mite Feces
- Viruses & Bacteria
- Mold & Mildew
- Pet – Cooking – Smoking Odors

**But what about bad air getting into  
my home or office space?**

We're glad you asked. Unlike HEPA filters, which rely on the air purification machine being powerful enough to "SUCK" the air in the from all corners of your home (which is impossible, without sucking your dog in as well!), Triad Aer goes out and destroys these harmful elements in your indoor environment.

So, as the air outside goes bad (forest fires, smog, VOCs, etc.) Triad Aer continues to protect you and your loved ones 24/7

**Why Choose Triad Aer?**

Triad Aer produces proactive air purifiers that use advanced technologies to scrub homes & offices of viruses, bacteria, mold, mildew, odors, pet dander, allergens, air-borne chemicals and gasses My Triad Aer's Products are second to none and now you can get the cleanest, healthiest air possible in your home and/or workplace.

**Triad Aer Technology Excels!**

**Cleansing Power of the Sun**

An air cleansing plasma is ejected out into the living space (up to 3,000 Sq. Ft.). This plasma creates molecules which "scrubs" the air clean of all pollutants.

**It Even Cleans Hard Surfaces**

My Triad Aer is NOT trying to suck pollutants, gases, dust mites, dander and more into a filter. Rather, just like the smell of cooking reaches every corner of your home, this cleansing plasma is able to go OUT where the pollutants are, destroying them on contact. It even kills flu viruses, allergy causing particles, and more.

**How Does it work?**

In simple terms, the machine creates an ionic plasma. Within this plasma there are molecules that oxidize gasses such as VOCs, odors, Smoke, that break down the toxic odors and smells through molecular dissociation. This process continues until all that is left is carbon dioxide and water vapor. Also in the plasma are negatively and positively charged ions that will attach to floating pollen, dust and other particulates. This process continues until they become so heavy that they fall harmlessly to floor -out of your breathing space. Oxidizing hydroxals and hydrogen peroxide molecules (also contained within the plasma) destroy viruses and bacteria on contact throughout your indoor space-even on surfaces ( a process called Lysis). In other words, Triad Aer is PROACTIVE!

**What Others Are Saying :**

"We found that the air in the office was always stale and not smelling very good when we opened up the clinic in the morning. Since getting the air purifier our air is much improved, always smelling clean and fresh, no matter what time of day or weekends; Patients have also noticed the difference when they enter the clinic." - Lisa R. - Chiropractic Office (Manager)

"Best purifier on the market! I am the owner of a multi-award winning hair salon in Massachusetts, where we have numerous chemical services being applied throughout the day. Our guests constantly comment on how it never smells like a traditional salon, and my team recognizes that we strive to make the workplace a comfortable and safe environment for all." - Chris K. -Salon Owner (Massachusetts)

**Breathe easier, Live cleaner, & Greener  
with our air Purifying technology.**

**Triad Aer V3**

- Best for Home/ Office/Condo & Apt.
- Covers up to 3,000 Sq. Ft.

Reg Price: \$1295.00  
Our Price: **\$1095.00**



**Triad Aer MINI**

- Good for spaces up to 250 Sq. Ft.

Price: **\$150.00**



**Also powerfully effective in:**

- RV's
- Boats
- Medical Clinics
- Massage & Spa
- Barber
- Hair/Nail Salons



**Wellness Way of Sturgis, LLC**  
64177 Rommel Rd., Sturgis MI 49091

**Phone: 269-651-6868**  
Fax: 269-651-8185  
Email: sarahsouthern@gmail.com

**DIRT DIGGER**

- AVAILABLE COLORS**
- RED
  - GREEN
  - ORANGE
  - YELLOW

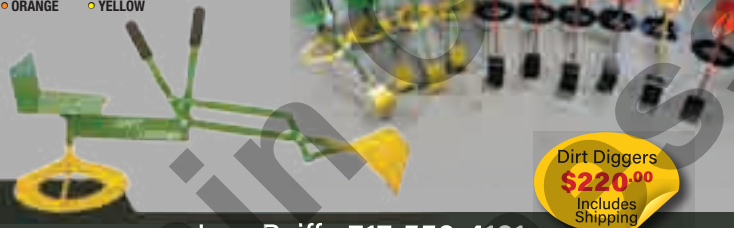

Dirt Diggers  
**\$220.00**  
Includes Shipping

Ivan Reiff • 717-556-4161  
350 Peace Rd. Leola, PA 17540

*Gift ideas* and cards

**Chevron braided throw**  
Page 42 of catalog



**Birthday cards**  
Page 54 of catalog

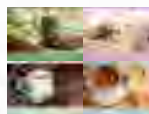

**Mugs**  
Page 41 of catalog



**WRITE TODAY TO  
RECEIVE YOUR FREE  
CATALOG!**

Sewing machines, sewing supplies, baby items, cookware, canning supplies, toys, and much more.



30339 Coshocton Road | Walhonding, OH 43843  
p. 740.427.4700 f. 740.427.1218

Keeping the sewing woman  
in stitches since 1980.

**Hey Parents!**

*How is your child doing in school?*

**Does your child...**

- Get frustrated and struggle with getting their lessons done?
- Work really hard and still make bad grades?
- Get really hyper and have problems with focus?
- Have low self-esteem or problems getting along with other children?

**It doesn't have to be this way!  
Try the dynamic duo**

**Brain Vitality....\$58.00**

**Body Shield.....\$47.00**

**Please include Birthday  
and \$12.00 Shipping**  
(please include 7% tax)

Also great for teachers, ministers, foremen, and busy mothers!

**ALSO ASK ABOUT THE HEALTHY COFFEE**

**Call today for FREE information or to order:  
Marvin & Mattie Marner  
7688 N 1100 E, Loogootee, IN 47553  
812-636-0113**



**NEED A SOLUTION FOR DIRTY EGGS?  
TRY A POWER SCRUB**

*"We strive to build a high quality washer at an affordable price."*

*"We provide air powered and lineshaft ready machines."*

**Features:**

- Processing capacity between 3,000 - 3,500 eggs per hour
- Constructed from food grade materials (stainless steel and HDPE plastic)
- Base unit may be purchased with these options:
  - ▶ LED candler
  - ▶ Turntable/side conveyor (for convenient packing)
  - ▶ Packing table
  - ▶ Drying fans



**POWER SCRUB MANUFACTURING - 663 Westfall Road, South Salem, OH 45681 • 937-981-5770**

*The Timber Trail Series*



- Hand Hewn Exteriors
- Pre-stained and Chinked
- Ready to Assemble

**FEATURES**

- Solid Log Walls
- Pre-cut Kits
- White Pine Logs



*Order Yours Today!*

**Stoney Creek CABINS**

Call: 660-773-5550 Fax: 660-773-5560 • David Schrock  
24913 Hennepin Place, Bevier MO, 63532

## Reliable Phone Solution!

### SAFE, SIMPLE, & AFFORDABLE!

*Not a lock-down or filter, These phones are built without internet capability!*



**No internet! No Games!  
No Social Media!**

*5" touchscreen, essential tools:  
Contacts, Messaging, Calendar,  
Calculator, Music Player, 8MP Camera,  
Photo editor, Protective cases & Screen  
protectors available!  
Runs on the nation's most reliable  
network!*

**Phones Priced at only \$99.99 !!!**  
**Unlimited talk and text only \$19.99/mo.**  
**Unlimited talk, text and mms  
messaging (pictures) \$24.99/mo.**  
 No contract required! Cancel anytime!

**SYFTKOG WIRELESS**  
 417-366-1652 or 417-456-4056  
 Mon - Fri 8-5 Central

## Reign Vitamin Sprays

*Spray everyday!*



**New Product!** Only \$15.00 each  
(1 month supply)

**4 Options**

- Reign Women's Multi
- Reign Vitamin C & Zinc
- Reign Vitamin D
- Reign Lean/Keto



- ◆ Get Nutrition into the bloodstream within seconds
- ◆ No filler formulation
- ◆ Great tasting
- ◆ Convenient alternative to pills, tinctures or IV
- ◆ Fast & effective

**Reign Sanitary Napkins \$6.00 / Package**  
 We also offer great bulk deals.

December is Customer Appreciation month.  
**FREE SHIPPING** on all Vitamin Spray orders of 5 or more!  
**STOCK UP NOW FOR THE WINTER!**

**Ivan & Naomi King** Email: [shadygrove31@sle.email](mailto:shadygrove31@sle.email)  
 588 Meetinghouse Road Website: [ivankingjewelpads.com](http://ivankingjewelpads.com)  
 Gap, PA 17527 phone: 717-371-5495



Your solution when perfection is the only option

Capable of high or low volume orders

## Custom Made Metal Parts

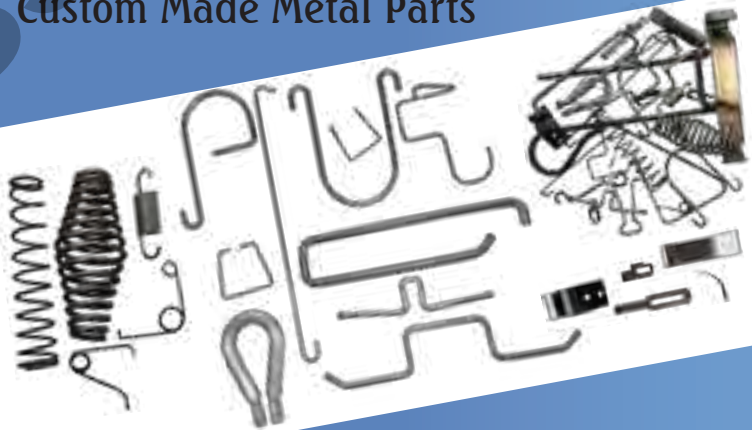

**Wire Forms • Springs • Clips**

Contact us for a quote

**TruPoint Products**  
 PO Box 72, Walnut Creek, OH 44687  
 PH: 330-204-3302 • Fax: 330 313-3439  
 Email: [myron@trupointproducts.com](mailto:myron@trupointproducts.com)



# PL PREMIUM POLYURETHANE

## Construction Adhesive

**\$6.00** 28oz.

**SKID PRICE DELIVERED**

**\$4.70** 28oz.



Glassboard/FRP  
4 x 8 x .090"  
Lt Brown Beige Smooth  
20 or more ..... **\$16.00**

FRP / Glassboard  
4 x 8 x .090"  
White smooth..... **\$22.40**

FRP / Glassboard  
4 x 10 x .090"  
White smooth..... **\$28.00**  
10 colors

### • VANITY TOPS

37" Single to 73" Double..... **\$80.00 - \$165.00**

### • GAF WATER BLOCK

Butyl Sealant 10.5 oz. tubes (Regular \$12.00)... **\$3.95**

### • RUBBER ROOFING

5' x 40' x .060 Black ..... **\$90.00**  
Insulation Fastners, 5" Screw 3" Washer..... **\$.36 ea.**

**CALL FOR SKID PRICING ON COMBINED PRODUCTS**

## RECENT SHIPMENTS – TRUCK LOADS

- Asphalt Coatings  
**\$29.00 to \$35.00 / 5 Gal.**
- 900 Tubes Roof Patch / Roof  
Cement – **10.1 oz / \$1.50 Tubes**

### 50# BOX NAILS

8D Common  
20D Common  
Some Rust  
**\$30.00**

### VINYL FLOOR PLANKING CLICK & LOCK

10 colors starting at  
..... **\$1.29** Sq Ft.

### PORCELAIN WALL & FLOOR TILE

12" x 24" x 3/8"  
8 colors ..... **\$1.40**  
Good for  
Feel Through

### • CHEST FREEZER

7 cubic foot ..... **\$290.00**  
8.8 cubic foot ..... **\$370.00**  
10.2 cubic foot ..... **\$400.00**  
14.8 cubic foot..... **\$650.00**

17 CF upright Freezer /  
Refrigerators..... **\$750.00**

**PLUS OTHER  
APPLIANCES &  
SIZES**

### EXCESS - SECONDARY COILS

403 Stainless 24Ga x 30" 42" 50" 52" Up to ..... **\$1.25** lb.  
Aluminum .032" Bare and Painted 48" ..... **\$2.50** lb.  
Aluminum .040" Painted 48" ..... **\$1.50** lb.  
Painted G90/AZ50 22Ga x 30" ..... **\$.60** lb.  
HR .055" x 14.40" Bare ..... **\$.40** lb.  
CR .115" x 4.25" FH ..... **\$.40** lb.  
CR .115" x 5.755" Tinted ..... **\$.40** lb.  
HR .100" x 5.94" Gr 55 Brown ..... **\$.40** lb.  
HR .100" x 13.94" Gr 55 Brown ..... **\$.40** lb.  
CR .0425" x 4" EDDS ..... **\$.40** lb.  
10-12 Ga 45" - 60" x 10' Flat Sheets ..... **\$.65** lb.  
Steel Angle 5" x 5" x 3/8" 10' 4" ..... **\$70.00** ea.  
Square Tubing 4" x 4" x .188 x 24' HDG ..... **\$150.00** ea.



Surplus & Discounted Building Products  
Phone: 717-445-5222 150 Slate Road  
Fax: 717-445-4841 Ephrata, PA 17522  
M-F 7AM-5:00PM Sat 7AM-11:30AM  
Dolgeville, NY 13329 • Phone: 315-429-3184

## Specializing in... HYDROSTATIC, PISTON PUMPS AND MOTORS



**Caterpillar  
Char-lynn  
Denison  
Dynex  
Eaton**

**Hitachi  
Kawasaki  
Komatsu  
Parker  
Poclain**

**Rexroth  
Staffa  
Sundstrand  
Vickers**

- Complete rebuild and repair facility
- Rebuild exchange program for Sundstrand
- New and remanufactured pumps, motors, and valves
- Current and obsolete models
- Units remanufactured come with a 1-year warranty
- Quick turn-around on Sundstrand units
- Large inventory of new, reman, and aftermarket parts
- Good prices
- Same-day shipping on parts

**Wholesale Discounts Available**

**Donegal  
Hydraulics**  
LLC

102 Haiti Road  
Quarryville, PA 17566  
**717.786.7001**

Where commitment to quality is priority one.





# Clinic for Special Children

## Help support families facing rare disease

Founded over 30 years ago to treat metabolic disorders, the Clinic for Special Children now treats children and adults with genetic disorders of all types. We are a comprehensive medical practice for patients where they can affordably see a doctor knowledgeable about their disorder for simple or complex medical needs.

Today, we serve over 1,100 active patients from 42 states and 17 countries, largely from the Plain communities.

### Our goals

Deliver **effective and affordable diagnosis and comprehensive care** for individuals with genetic conditions.

Develop innovative laboratory methods that **serve the needs of patients and families.**

Expand the capability for **clinical studies, education, and training** in genetic medicine.



### Words from families

“Our wish is that **every family** dealing with medical needs could **experience the type of difference** the Clinic for Special Children has **made in our son’s life.**” - Hurst Family

“The Clinic for Special Children is **the most helpful place** to go for the **treatment of genetic disorders.**” - Mother of a Patient

“It’s **hard to put into words** how the Clinic for Special Children has **so profoundly impacted our lives!** Too often we take for granted that **our dear daughters are living healthy, mostly-normal lives when things could have been so different.**” - Martin Family

### Please consider supporting the Clinic’s work:

#### By Mail:

Clinic for Special Children  
Attn: Development (PCBE)  
535 Bunker Hill Road, P.O. Box 128  
Strasburg, PA 17579

#### Online:

Please visit our giving page  
at the below address:

[www.ClinicforSpecialChildren.org/Give](http://www.ClinicforSpecialChildren.org/Give)

If you wish to make an anonymous contribution through the Charitable Gift Fund Program at Anabaptist Foundation, please email [giftfund@afweb.org](mailto:giftfund@afweb.org) or call 1-800-653-9817 ext. 209.

P.O. Box 128, 535 Bunker Hill Road, Strasburg, PA 17579 T 717.687.9407 F 717.687.9237

The Clinic for Special Children is a Pennsylvania non-profit corporation and a 501(c)3 public charity for US federal and state tax purposes (Tax ID #23-255373). The official registration and financial information of The Clinic for Special Children, Inc. may be obtained from the Pennsylvania Department of State by calling toll free, within Pennsylvania, 1 (800) 732-0999. Registration does not imply endorsement.





# KEYSTONE BATTERY SOLUTIONS

## Generic Batteries



9 amp 20v Generic battery. Replaces Dewalts 9 amp battery but is not a flexvolt  
**\$89.95**



6 amp 20v Generic battery. Replaces Dewalts 6 amp battery.  
**\$59.95**

5 amp 20v Generic battery. Replaces Dewalts 5 amp battery.  
**\$54.95**



#A518



This is an 18V, 5amp lithium battery. Fits all 18V DeWalt tools and lights. It also has a fuel gauge to see how full your battery is. Gives you the same power and run time as the 20V DeWalt 5amp slide on battery. Charge with your regular DeWalt charger. 1 yr. warranty  
**Only \$69.00**



**KB-300 - \$145.95**

Lights are the KB-300 3-Bulb light and the KB-200 2-Bulb lights. All lights are available with 20V DeWalt, 18V Milwaukee, and 18V Makita batteries.

Prices are for the bare lamp. Bulb, battery and shade are priced separately.

**KB-200 - \$129.95**



## FEATURES:

- 18 to 20V DC
- Output -120V AC
- USB 5V output
- Low voltage disconnect
- Short circuit protection
- Overload protection



**500 Watt Pure Sine Wave Inverter... \$179.00**

**300 Watt Pure Sine Wave Inverter... \$129.00**

**Use Your Power Tool Battery To Power Your Buggy Lights!**

Adapter converts your 18V DeWalt tools and lights to 20V and/or 18V Milwaukee batteries. Also has USB Port.  
**\$29.95**



**KB-SBX5 • \$59.00**



**KB-SBX9 • \$79.95**

The KB-SBX9 has 2 adapters, a 5A DC converter, and a 3 position switch to change from one battery to the other and a beeper to alert you when to change batteries. The KB-SBX 5 is a single unit for only 1 battery and has the same DC converter and beeper.

**378 South Belmont Rd. • Paradise, PA 17562 717-687-8482**

**Now is a good time to order to beat the fall rush.**

*True Essentials*



**Essential Oils**

**Herbal Tinctures**

100% Pure Therapeutic Essential Oils -

Low Temperature Distilled

**ATTENTION Wholesale Buyers: FREE DISPLAY Ask for details.**



**WHOLESALE/RETAIL**

**"We Ship All Over the US"**

**Allen & Martha Sue Herschberger**

15815 230th Street

Bloomfield, IA 52537

For a wholesale or retail price list, call:

**641-929-3078, ext. 2**





# Green Valley

## METAL WORKS

*Your project is our Specialty*

### Custom Mig and Tig Fabrication

**Stainless, Aluminum, Mild steel**

**330-621-4328** | davidmiller@safecommail.com  
7243 TR 668 Millersburg Ohio 44654

**Give us a try before you buy**

5 year Warranty/Horse



28" L x 7" W x 8.5" H

**Dealers Wanted**

—Clip Ad—

Ida's Gift Shop  
227 Highland Park Rd  
Punxsutawney PA 15767

### Designing & Building of : Automated Industrial Machinery



Injection Molds  
Tool & Die Work  
PLC Programming  
Pneumatics  
Hydraulics  
Hydraulic Hoses

**Millcreek Machine**  
Designing and building of custom machinery  
1340 Township Road 111 Millersburg, Ohio 43104  
PH: 330-897-9755 Fax: 330-897-1124

Mr. Con Shipt

## Air Cylinders, Valves, FRL's & Accessories

### MANN FLUID POWER CO.

2249 N. Cleveland-Massillon Rd.  
Akron, OH 44333  
Phone: (330)659-6671  
Fax: (330)659-6581  
www.mannfluidpower.com  
Sales Contact: Ed Mann  
sales@mannfluidpower.com

### Small Barn Truss Press



The Riehl Steel Truss Press has three press stations. The cylinders are controlled by a single control valve, you hold the lever down till the plates are pressed in and push the lever up to retract the cylinders. The truss plates are kept in place by a precision spring plate.

The 2 stage hydraulic pump makes for a 4-5 second cycle time. The unit is powered by a 3 phase 5 HP motor complete with controls. We build the press around your needs. Contact for more details.

**Starting at \$9,975**

**Riehl Steel LLC** | 95 Cedar Drive, Lewisburg PA 17837 | 570-718-0665  
riehlsteel@gmail.com

## Plug & Play LED LIGHTS

West Ridge Supply 715-644-5998

<p><b>TL9660</b> Cab LED Light Kit for JD Combines Price: \$920</p>	<p><b>TL730</b> LED Corner Headlights for John Deere Tractors Lumens: 2,000 Price: \$115 ea.</p>
<p><b>TL8060</b> LED Work Lights for John Deere R Series Tractors &amp; S Series Combine Lumens: 3,000 Price: \$95 ea.</p>	

**Ask Us About Our Kits** | Our Lights Have A Limited Lifetime Warranty | **TIGERLIGHTS Distributor** Call for catalogs and pricing.

7420 Cty Hwy G, Stanley, WI 54768 | 715.644.5998 • fax: 715.644.4998

# ZIMMERMAN'S HAY, LLC

Premium Alfalfa, Grass Hay and Wheat Straw

Delivered to your farm - big square and big round bales.

Premium Quality Certified Organic Hay Available

Premium Quality Alfalfa Orchard Grass Available



zimmy@nemr.net | 660.216.0938 • 660.341.1780



Meeting all of your nylon fabric needs; oxfords, packcloths, lightweight to heavyweight Westmark has you covered.

## Nylon Fabrics

**CLOSEOUTS — SECONDS — POUND GOODS**  
GREAT FOR MAKING HORSE BLANKETS, DOG BLANKETS, BAGS AND MANY OTHER APPLICATIONS

**REQUEST YOUR FREE SAMPLES OR CATALOG TODAY**

www.westmarkcorp.com • 1-800-423-7829 • Contact: Michael@westmarkcorp.com



Intelligent  
**Lithium Iron Phosphate**  
**Battery** LiFePO4

**New Horizon Battery Co.**  
Since 2017



*The Premium option for  
your next solar system  
or carriage battery!*

**Power and  
performance  
you can  
depend on for  
many years!**

*Sizes Available:*

450AH 24V - 300AH 24V - 100AH 24V - 275AH 12V - 200AH 12V  
100AH 12V - 75AH 12V - 50AH 12V - 20AH 12V - 12AH 12V

*Call us for a free Catalog or to  
locate your nearest dealer!*



2058 CR 1800 E  
Arthur, IL 61911  
Ph: 888.475.9697 • Fax: 217.543.3296

*We also stock these items*  
New Horizon Lithium batteries • LED Floodlights • Headlights  
LED Corn lights • Battery Adapters • Solar Controllers • 12/24V Inverters  
Solar Panels • 12V Fans • Tool batteries and more

*One Chance, Aim Wisely!*

**Hitz Halter**

**Quality. Performance. Lasting Value.**



- ✓ Energy Efficient
- ✓ Termite Resistant
- ✓ Strong & Dependable
- ✓ 4'x24' Fan Folded For Easy Installation

**Below Grade Insulation:**  
*A Choice  
You won't regret!*



'Hitz' your bottom line!

HitzHalter@HersheysMM.com 877-661-3030

420 Progress Drive  
Mattoon, IL 61938





Shadelight without bulb and battery \$80.00

10 watt = \$24.95  
15 watt = \$28.95  
20 watt = \$34.95



Free Shipping on Purchase of \$400 and Over

FARM BUILDING SUPPLY



12916 Cuba Road, Grabill, IN 46741 | 260-710-1341  
Voice-Mails and Text Messages Welcome

PARTIAL SHIPPING MAY APPLY TO LARGE BOXES

BUY A KIT BELOW

AND GET A FREE TOOL

**XT288T..... 5.0..... \$400.00**  
Impact XDT 16Z + HD Drill XPH 14Z

**FREE Battery BL1860**  
\$115.00 Value

**XSH06PT Kit..... \$369.00**  
18V LXT Sub-Compact Brushless Cordless Circular Saw,

**\$100 OFF**

4 1/2"-5" Grinder <b>XAG04ZBL</b> \$135.00	1 battery blower <b>XBU03ZBL</b> \$129.99	Sander <b>XOB01Z</b> \$100.00	Multi tool <b>XMT03Z</b> \$119.00
Tire Inflator <b>DMP180ZX</b> \$100.00	Router <b>XTR01ZBL</b> \$130.00	Jig Saw <b>XVJ03Z</b> \$159.00	Recipro Saw <b>XRJ04Z</b> \$109.00
1-Speed Impact <b>XDT13ZBL</b> \$90.00	6 1/2"-Saw <b>XSS02Z</b> \$100.00	Drywall Screw gun <b>XSF03ZBL</b> \$149.00	Vacuum sweeper <b>XLC02ZB</b> \$79.00

CALL FOR DETAILS ON BARE TOOL SPECIALS

18v Jigsaw <b>XVJ02Z BL</b> \$269.00	18v Rotary Hammer <b>XRH01Z BL</b> \$289.00	4 1/2" - 5" <b>XAG04Z BL</b> \$135.00	4 1/2" - 5" <b>XAG11Z BL</b> \$179.00	1180 FT lbs <b>XWT08Z BL</b> \$249.00	740 FT lbs <b>XWT18Z BL</b> \$239.00	1 Battery Blower <b>XBU03Z BL</b> \$129.00	
Recipro Saw <b>XRJ05Z BL</b> \$189.00	6 1/2" Saw <b>XSH03Z BL</b> \$189.00	Top Handle 10" <b>XCU06Z BL</b> \$189.00	3 1/4" Planer <b>XPK01Z</b> \$179.00	3 1/4" Planer <b>XPK02Z BL</b> \$249.00	Worklit 10,000 Lumens <b>DML809</b> \$249.00	3,000 Lumens <b>DML811</b> \$179.00	2 Gal Vac <b>XCU11Z BL</b> \$179.00

**XPG01Z** **NEW**  
\$229.00  
18V LXT® Lithium-Ion Grease Gun, Tool Only

Add cyclone attachment increases vacuum and saves filters  
**XLC02ZB** ..... \$69.00  
18V LXT® Lithium-ion Compact Cordless Vacuum, Tool Only

Spot Light 1250 Lumens  
**DML812** ..... \$100.00

240 Lumens Reading Light  
**DML801** ..... \$55.00

160 Lumens Flash Light  
**DML815** ..... \$45.00

**XT287SM1..... \$199.00**  
18V LXT® Lithium-Ion Brushless Cordless 2-Pc. Combo Kit (4.0Ah)  
1 - battery blower  
1 - battery weedwhip  
1 - 4.0 battery  
1 - Single charger

While supplies Last  
**XRU15PT1** ..... \$399.00  
36V (18V X2) LXT® Brushless String Trimmer Kit with 4 Batteries (5.0Ah)  
Uses 2 18v LXT Batteries

Tower Light  
**DML813** **NEW** ..... \$299.00  
3,000 Lumens  
18V LXT® Lithium-Ion Cordless Tower Work Light, Light Only

**XDT14Z** ..... \$100.00  
18V LXT® Lithium-Ion Brushless Cordless Quick-Shift Mode™ 3-Speed Impact Driver, Tool Only

Tower Light Directional  
**DML814** **NEW** ..... \$349.00  
3,000 Lumens  
18V LXT® Lithium-Ion Cordless Tower Work Light, Light Only

**XDT16Z** ..... \$159.00  
18V LXT® Lithium-Ion Brushless Cordless Quick-Shift Mode™ 4-Speed Impact Driver, Tool Only

## JOB COSTING: NOW TO FIND THE TIME

Keeping in mind that the overall goal of this series is Job Costing, let's do a quick recap before we proceed.

As a coach, I generally use Job Costing to help clients improve their profitability. There are two fundamental ways to improve overall profitability: 1) Increase sales, or 2) Improve the per-transaction profitability. Lately, it seems most companies are doing well with their sales, so we then look at the per-transaction profitability. Per transaction means the profitability per unit or piece of thing you make and sell. For a restaurant, it's per meal. A furniture shop, it's per chair. A pole barn builder—per building. The way I see it, if we can be sure you are making a healthy profit per transaction, and you have a healthy number of transactions, you are all but guaranteed to have a healthy business.

If you have been following the series, Fred first calculated his average hourly wage. Then, in the last article he figured out his overhead per hour. Now we need one more piece to this puzzle—the time. Fred needs to figure out how long it takes his employees to produce each item they make and sell. Let's check in and see how he's doing.

Before anyone knew it the year was nearly over. December arrived and the first snowstorm of the year had suddenly come late one Friday afternoon. Fred was standing in the kitchen early the next morning enjoying the sight of the untouched snow in the front yard. Sarah walked into the room, stood next to Fred, and looked out the window. "Wow, I didn't think we were expecting that much snow."

"I didn't think so either. Last I heard they were calling for only three inches or less." Fred replied.

"Well, it's a good thing I had the boys dig the shovels out of the shed yesterday. The only thing is...I think they were playing with them and left them in the yard."

Fred laughed, "A lot of good they're going to do us today." He shook his head and smiled. "They're going to be so excited when they wake up and see how much snow we got last night. We'll have to have them try to find the shovels while they're out playing. I'd guess at least one of them remembers where they had the shovels last."

"I'm sure they do," she said while pulling a box out of the

kitchen closet. "Speaking of finding things, look what was in the shed."

Fred turned from the window to see Sarah holding a box of clipboards. "You found them! They were in our shed?" Fred stroked his beard and puzzled for a minute, "I really was sure they were in the shed at work. I guess it makes sense now that I looked everywhere and couldn't find them."

Sarah smiled, "You were right that they were in the shed, you just had the wrong shed."

He laughed, "Thank you, Sarah. I'm glad you found them before I ordered more. I wanted to start timing production this week but really needed these first. Now I just need a few stopwatches. You didn't happen to come across a box of those by chance, did you?"

"I didn't. Are you sure that you ordered stopwatches before? I can't remember ever seeing any."

"No, I don't think I have, I just thought it would be worth asking. I think even a few small kitchen timers would work."

"Oh, okay. Well, I have to run into town today, if the roads are cleared by lunchtime that is. If I see any I'll pick a few up."

"I appreciate it. Now I'm going to wake the children."

"Wake them up? It's still early yet," Sarah said, sounding a bit confused as to why Fred would want to cut their Saturday morning quiet time short.

"I know, but I think they'll want to eat some breakfast soon and go play in the snow," he said with a grin.

Sarah smiled back. "I think you want to play in the snow just as much," she said, knowing how much Fred loved the snow.

Fred got to work a bit early on Monday to clear the remaining snow and ice from the walkways and the stairs. He had just finished clearing the sidewalk from the gravel parking lot to the shop door when he heard something whiz by and splat on the siding not far from where he was standing. He spun around to see Elam standing at the end of the sidewalk looking behind him as if to see where that snowball came from. He turned back toward Fred. Trying to contain his smile said, "Boy that was odd, I heard it go by but



who knows where it came from.”

Fred squinted his eyes and played along, “Must have been one of the horses on the neighbor’s property,” he said pointing about a quarter mile down the road.

Elam laughed, “Okay, I can’t have innocent horses being blamed. I threw the snowball.”

“You should’ve come over Saturday morning. The boys and I had a snowball fight. It’s funny now that they’re getting a little bigger, I have to really work to avoid being hit,” he laughed. “Or maybe it’s that I’m not as young as I used to be.”

Elam chimed in, “It’s probably a little of both.”

The two men walked through the shop door and into the break room. Elam saw the stack of clipboards on the table. “Oh, you tracked them down. Great! Where did you end up finding them?”

“It turns out they were at home in my shed. I was sure I had them in our shed here at the shop. Who knows how things like that happen though?”

“Well, now that you’ve found them, what are you going to use them for?”

“Actually, you’re going to use them.”

“Me?”

“Yep.” Fred put his briefcase on the table and opened it to get his coaching folder. He took out the time tracker worksheet and handed it to Elam. “I want to start timing production this week.” The look on Elam’s face instantly changed, but Fred didn’t take notice as he was reaching into the cupboard for a coffee cup.

Fred continued as he poured himself a cup of coffee, “We can’t start yet, though. I haven’t found my stopwatches. Sarah went shopping on Saturday but didn’t come across any either, so I’ll make a few calls this morning to see if I can rustle up a few. I’ll let you know when I track them down and am ready to start timing.”

“Well, I better get to it,” Elam promptly replied as he walked through the door and headed toward the production floor.

“You don’t want any coffee?” Fred asked. He turned around to see an empty break room. “Huh, I guess I was talking to myself just now,” he thought. “Elam almost always takes a coffee with him in the morning—odd.” He picked up his briefcase, clipboards, and coffee, and walked over to his office.

Walking through the door, he plopped the clipboards and the briefcase down on his desk, opened the top left drawer and pulled out his address book. He sat down and made some calls to see where he could buy a few stopwatches. An hour later he was at the end of his address book and still hadn’t found anyone with what he needed in stock, so he turned his focus to the phone book and called any store that he came across that he thought would have what he needed. He sat back in his chair and sighed, “This is ridiculous. Who would have thought getting a few stopwatches shipped here within a few days would be so difficult?” He looked at the calendar, “My next coaching session is in three days and it looks like anything I order won’t be here any time before that.”

He tried to think of other options he might have but felt rather unsuccessful. He decided he would call Coach Lynn to see if were possible to reschedule the next session. He dialed the number and the ringing on the other end was immediately interrupted.

“Good morning, this is Lynn,” Coach answered.

“Good morning, Coach. It’s Fred. Do you have a minute?”

“Of course, Fred. What’s up?”

“Well, I’m up against a wall with trying to find timers for the clipboards. I’ve called everyone I can think of and it looks like nothing is going to get here within the next few days. Can we push our next session out a week?”

“I’ll check my calendar,” Coach Lynn said. “Yes, if we go out one week exactly I can make that work.”

“Okay, great. Sorry to throw a wrench in the cogs. Some of these shipping delays and product availabilities are just crazy. I was thinking if I ordered a set of timers I would have them in a few days, but it’s looking like the best case scenario is two weeks.”

“I understand. It really has affected pretty much every industry now. The only thing we can do is try to stay on the ball as much as possible. So, good luck with your timer search, and I’ll talk to you next week.”

“Thanks again, Coach. I’ll talk to you then.”

Fred wondered if Elam had any ideas on finding some timers. He went out to the shop floor and tracked him down, finding him at the air compressor topping off the oil.

“Hey, Elam,” Fred called out. “I was wondering if you might be able to help. I’m looking for some timers and nobody seems to have any.”

*Job Costing - Continued on Page 182*

Elam turned and Fred noticed his uneasy expression.

"What's going on? You alright?" Fred asked.

"I just...um, there's only so many hours in a day, Fred. I can't be everywhere at once. This here needs a gasket. The men have been working hard, but we can't get some of the materials in here...." Fred became more puzzled as Elam vented.

"Whoa. Slow down, Elam. I'm not sure I understand what's got you so worked up."

"Well, you said you wanted to time production. I honestly can't see how we can squeeze any more out of the workday."

Fred immediately knew what was happening. "Elam, it looks like we have a complete misunderstanding here. I'm sorry for not explaining this more thoroughly. I want to time production so I can figure out how much profit is in every item we make. It has nothing to do with how fast or efficient you men are in production, honest. It's more about checking my pricing and quoting than anything."

Elm visibly relaxed. "Well, I guess I got myself all worked up over nothing. Sorry to blow up on you there."

"It's my fault, Elam. I should have explained why initially, and had intended on doing so. It just slipped my mind."

"It's understandable. I know we've all been stressed lately with the supply issues. So, back to your question, I don't think I've seen any timers laying around. We do have the wall clock out here, but you can't see it from every work station in the shop."

"Okay, I guess I'm back to the drawing board. I might as well just order something and hope they get here before the end of the year. Thanks for your help, Elam, and I apologize again for not being clear with you." When Fred returned to his office he sat down to browse several business catalogs and to decide where he'd place his order. The frustrations over the supply chain shortages were affecting everybody, and the day's misunderstanding really brought it out in the open. All he could do was hope things would turn around soon.

*Not sure on how much profit you make on each job or if there is profit in each job? Call for help with Job Costing to get a clearer profit picture. Kristen Fisher 570-472-2818*

# EssaWARE

Making Meals & Memories

## PIE SAVER

**Fill it. Stack it. Twist it. And GO!**

A stackable set of inter-lockable food containers to store, carry, and serve anything that fits.

With a Pie Saver, you can take those delicate pies along to the family gathering, or fill it with delicious goodies for a friend in need, or use them in your pantry and on the table. Dream on...

- Clear construction lets you see what is inside
- Durable, lightweight, BPA-Free
- Use one or multiple containers
- All pieces interlock by slight twist
- Fits pie pans 9" in diameter or smaller
- One set includes 4 containers and 1 lid; 9" ID, 10½" OD x 12" H, 4.5lbs.
- Single piece units available to expand your set; 9" ID, 10½" OD, 2¾" H, 1 lb.

**Pie Saver Set ..... 1500...Retail \$49.95**



## PIE SAFE

A safe and convenient way to store or transport pies, the new EssaWARE Pie Safe includes a see-through sliding front cover, and adjustable shelves to hold 4 regular pies, 3 deeper pies, or 2 cakes. Includes a close-able vent, and a grab-n-go handle.

- Clear front lets you see what is inside
- Durable, lightweight, BPA-free
- Fits any pans up to 10" diameter
- Spacing between shelves; 2" with 4 shelves, 2¾" with 3 shelves, 5¾" with 2 shelves
- 11¼"W x 11¾"D x 12"H; 4.3 lbs.

**Pie Safe..... 1510...Retail \$55.50**

**Helpful Hints - Pie Carriers**

**PIE SAVER or PIE SAFE?** Each has it's own advantages. The Pie Saver can be used for so much more than just pies, plus you can stack as many or as few as you want. But the size is limited to 9" diameter pans, and has vent holes that can not be totally closed. The Pie Safe holds bigger pies, has a close-able vent, and is more convenient. It includes adjustable shelves for 3 or 4 pies.

**SPROUTING** Growing your own sprouts is rewarding and healthy. With a Pie Saver, it only gets better. Not only can you grow bigger batches than in glass jars, they also grow better. Instead of curling up, they grow straight and crisp... mmm!







375 Old Dam Road  
Christiana, PA 17509  
**610-593-5193**

Made in USA

Ask for EssaWARE products at your local store,  
or add \$12.00 shipping and 6% sales tax.

DEALER INQUIRIES  
WELCOME



# Gas & Kerosene Lamps & Lanterns

Propane Lighting is our specialty!

(approx. 6' tall)

500-564 K 500-564 N  
**\$225**

Are you tired of maintenance on Hipo & Petromax? Try a bright, easy-to-maintain light built by HC Lanterns, Lancaster, PA!



**(717) 786-1049**

418 Furnace Rd,  
Quarryville, PA 17566

All repair parts available at HC Lanterns or your nearest dealer.

K = Kerosene  
N = Naptha/White gas

(Price subject of change without notice. Prices in this ad do not include shipping.)

The Lightning Bug



**\$338**

The Firefly



- Gas or kerosene
- Extremely strong stainless steel tanks!
- 2.5-qt. fuel capacity

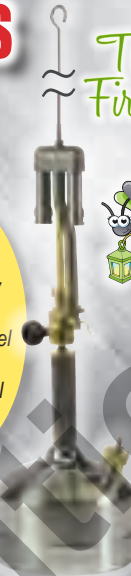

**\$294**

(Fits on Leacock tank)

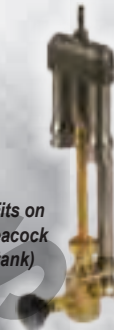

**\$98.75**



5972

**\$25**

Tire Pump with gauge

500FK	Head for kerosene floor lamp	\$98.75
500FN	Head for naphtha/gas floor lamp	\$98.75
500HK	Head for hanging kerosene lamp	\$98.75
500HN	Head for hanging naphtha/gas lamp	\$98.75

Are you always tired? 😞  
**LOOK** what we found! 😊

## Some Great Benefits

- ☑ All Day Energy
- ☑ Weight Loss
- ☑ Digestion
- ☑ Heart Problems
- ☑ Reduce Blood Pressure
- ☑ Balance your Sugar

Detox Enhances Clarity



Your All Day Energy

Weight Loss  
Lose it slow and wave it goodbye



Ask about our other products

## ELECTRO-RADIATION IS THE PROBLEM



### Protects You From The Problem IT'S A SOLUTION

- May Help Promote Blood Flow
- May Help Relieve Inflammation
- No. Drugs, No Eating, No Rubbing Anything On
- May Improve Sleep
- May Provide Migraine/Headache Relief

This Product is not intended to treat any disease or cure any illness. It is not approved by the FDA. All product claims are based on real users' testimonials.

To Place an order, call:

FitLine Nutrition

**Free Shipping**  
on \$50.00 + orders

**260-593-0493 Fax: 1-260-350-9008**  
Willard & Leona Yoder 7717 W 1200 N - 57 Topeka, IN 46571

## ATTENTION METAL ROOFERS ROOF EXHAUST ADAPTER KIT



REDUCERS & UPPERS



Adapter was made for bath fan exhaust on metal roofs, mainly found on single and double wide trailer houses.

2" pvc pipe fits in top - 3" pvc fits in bottom. Bottom is made to fit inside flex hose. Adapter is set at 4/12 pitch.

2" KIT.....\$25.00  
3" KIT.....\$40.00  
ADAPTER 2" or 3" ...\$15.00  
Call for Quantity Discounts

**END OF SUMMER SALE  
15% OFF  
Any Size Order  
FREE Shipping  
till end of year.  
Must be prepaid orders to get special pricing.**

**NEIL'S ROOFING  
SPECIALIZING IN METAL ROOFS**  
260.463.1367 | fax: 260.463.2883  
12520 CR 4, MIDDLEBURY, IN 46540

Liquid Crystal  
Pond Enzyme

## Pond Owners:

If you are having problems with dirty, murky water in your pond, and it's hindering your enjoyment of the water, try Liquid Crystal Pond Enzyme!

Liquid Crystal Pond Enzyme is a specially formulated multi-enzyme blend that helps digest the old leaves, dirty muck, and other organic solids in your pond. After only a few treatments, our customers are experiencing clean, crystal clear water!

- pH Neutral
- 100% Environmentally safe
- No Harsh Chemicals
- Non-Toxic and Non-Pathogenic
- Breaks down & digests existing solids
- Reduces offensive odors

\$24.99/Signal +Shipping

Swiss Perfection  
100 S Huntington St. • Syracuse, IN 46567  
Ph. 574-457-4457  
Fax 574-457-4457



**Creative Wedding Designs**

We Know *Weddings* ... so let us help you with yours!  
 We offer custom stationary, gifts, and favors.  
 Everything you need to make your special day just a little more special.

Send \$10 for New Catalog

Telwood & Lullita Bookbinder  
 4001 West 63rd Avenue  
 Shipshewanna, Indiana 46561  
 PH: 219 - 798 - 3247  
 Fax: 219 - 768 - 7883

Dealer inquiries welcome in select locations.

**Fehr**  
 Torsion Gears & Axles

The Original **Steel Spring Torsion Gears**

**Other products:**

Model 450 1 Ton Torsion Wagon

Model 350 (Fifth Wheel Torsion Gear)

Model 225 (Horse Size Axle)

Model 125 (Pony Size Axle)

Model 250 (Auto Steer Gear)

Manufactured by:  
 Gateway Sales  
 52056 Glencolin Line  
 Aylmer ON N5H 2R3 - Canada  
 Ph: 1-800-705-4004  
 Fx: (226) 781-1773

Call to request our free catalog.

**Dealers Inquiries Welcome**  
 Ask for these items at your local buggy shop.

**GODS WORD**  
 ENDURING THROUGH THE AGES

**THE HISTORY OF THE ENGLISH BIBLE**

Contact us to request **FREE COPIES**

**ALL-NATIONS BIBLE TRANSLATION**

814-826-3750 | office@abtmill.org

All-Nations Bible Translation  
 150 All Nations Lane  
 State College, PA 16801

Designed to confirm your confidence in the Bible, this nine-part series explores evidence showing that God inspired the Scriptures, preserved their text, and authenticated the canon of 66 books.

VIDEO DVD | 2 hours

Also watch online at:  
<https://allnationsbt.org/gods-word-film>

We read the Bible in English every day. Do we thank God for the opportunity?

Hear the stories of William Tyndale and others who risked their lives to give us this privilege.

AUDIO CD | 42 minutes

Also listen online at:  
<https://allnationsbt.org/english-bible>





AIR?

### Choose a Workhorse!

#### 10 HP Sierra Screw Air Compressor

Retail-\$4,550

- Long term, economical
- Line shaft ready
- Compact footprint
- Heavy duty, welded steel construction

Dealer Pricing Available

#### Benefits vs. Piston Compressor

- More CFM Produced per HP
- Produces less moisture downstream
- Temp-controlled with High temp shutdown
- Cleaner, higher quality air



100 N Industrial Pkwy - Arthur, IL 61911  
Ph:(217) 543-2022 - Fax:(217) 543-2224

# The Hay Hoarder



The Hay Hoarder is an equine slow hay feeding system. A perfect choice for horse owners who are tired of seeing hay (also known as hard earned money) strewn all over stall floors.

Some of the great unique features of The Hay Hoarder are:

- Large open top to allow for easy filling
- Simple installation using 5 bolts to fasten to your wall location
- Reduce your hay consumption using the slow feeding hay net
- Dramatic reduction in wasted hay
- Sturdy steel construction, powder coated for extra protection.

The Hay Hoarder Hopper measures 36" wide x 16" deep x 14" tall.

The high quality slow feeding hay net measures 40" long and has 2" feed through holes.

Hay Hoarders are now available for purchase \$150.00 each plus shipping and handling

Please contact us for any dealer inquiries

#### DEALER

MT. HOPE ELEVATOR  
8102 STATE ROUTE 241  
MILLERSBURG, OH 44654  
PHONE: 330-674-5167

TYLER ROAD HARNESS  
11541 TYLER ROAD  
BREMEN, IN 46506

COUNTRYSIDE MACHINE  
19709 200TH STREET  
LONG PRAIRIE, MN 56347

Hay Hoarder  
www.hayhoarder.com

#### Hillside Metal and Supply

ANDY JM MILLER  
3005 RT 76, SHERMAN, NY 14781  
PHONE: 716-761-2005

EXPERIENCE THE POWER OF REVITALIZED WATER with the original

## WATER REVITALIZER

HOME, BUSINESS AND GARDEN - Enjoy all the benefits of revitalized water for cooking, drinking, showers or baths, laundry, gardening, pets and so much more.

- Super hydration
- Helps neutralize toxins
- Eliminates itchy skin from chlorinated water
- Reduces hard mineral build-up in pipes
- Increased oxygen of nutrients
- Healthier skin and hair
- Healthier, happier pets with less stress
- Less infections and disease in house and garden plants.

STAINLESS STEEL

FREE SHIPPING



16853 Eagle Boulevard  
Drakesville, IA 52552  
641-722-3100  
Available 8-8:30 AM Central Standard Time, Mon.-Fri.

120 DAY MONEY BACK GUARANTEE

NO FILTERS TO CHANGE EXPANDABLE SYSTEM  
Static Unit (2 pieces) \$1304.00  
Home Unit \$898.00  
Garden Hose Unit \$489.00

## NEW FROM Pequea Publishers

### Stocking Stuffer Sale

Free shipping on all orders received by DECEMBER 25<sup>TH</sup>

- A soft cover German carry Bible with Old Testament, New Testament and Apocrypha
- Measures 6 1/4 x 9 1/2 x 1 1/4
- Martin Luther version with five full page color maps
- 1,500 pages
- Easy to read 12 point Fraktur font
- Comes with two beautiful gold ribbon markers
- Orders must be paid within 10 days of invoice date to qualify for free shipping.
- PA Residents must add 6% sales tax
- Single copy price is

\$42<sup>50</sup>

Call us for wholesale pricing.



Pequea Publishers LLC - 3981 E. Newport Road, Gordonville, PA 17529 | 717-768-0444



## Transport Metal Roofing Panels Damage-Free



Shrikes are designed to replace wood blocking used between bundles of roof panels in transport.

- No more paint rubbed off
- No scratches
- No more squished ribs

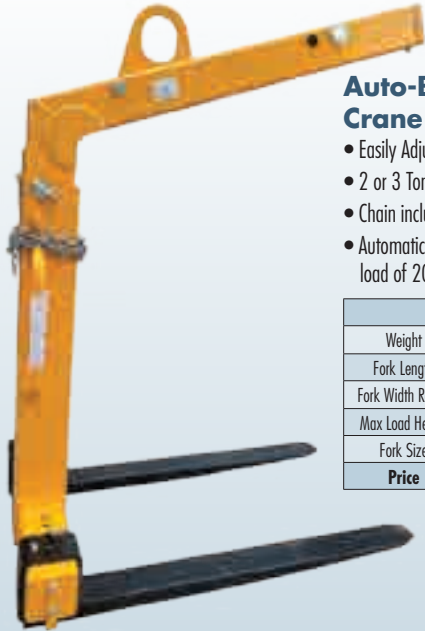

### Auto-Balancing Overhead Crane Pallet Lifter

- Easily Adjustable Height and Width
- 2 or 3 Ton Capacity
- Chain included for load securing.
- Automatic balancing system requires minimum load of 20% of working load limit

	2 Ton Capacity	3 Ton Capacity
Weight	486 lb.	618 lb.
Fork Length	48"	48"
Fork Width Range	14"-36"	14"-36"
Max Load Height	78"	78"
Fork Size	4.75" x 1.6"	4.75" x 2"
Price	\$2,200.00	\$2,600.00



Phone: 336-488-1128 www.albatross.supply • email info@albatross.supply

# Perkins Diesel

## NEW & USED DIESELS

## DIESEL REBUILDING

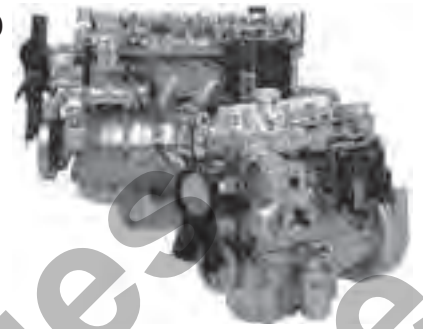

Diesel Air Compressor Units for Home Owners

Industrial Power Units

**Battery Packs | Inverters | Solar Panels**  
**Air Compressors | Clutches | Belts | Batteries**  
**Brad Penn Oils | 12V & 24V Alternators**  
**Reman Diesels in Stock**



125 Leacock Rd. • Gordonville, PA 17529

717.355.2606

Owner: Leroy Smucker



Contact Eagle Food Equipment for Wholesale opportunities or to order products

5162 Parks West Rd | Middlefield, OH 44062 | (833) 693-4144

### Cordless Tool Battery Vacuum Sealers

(with digital scale)  
Perfect for Kitchen counter-top! Seal and freeze excess veggies and garden goodies. Seal your venison for exceptional (2 years or more) freezer life!



### MEAT GOBLER Electric Meat Grinders

#12 - #22 - #32

All New Eagle Food Equipment Stainless Steel #32 Meat Grinder. The best quality manual grinder available! Has a bearing to minimize side pull. 2 year warranty!



### Meat Mixers

(handcrank or attach to grinder)



### Sausage Stuffer



### Barbeque Sauce

Try this one of kind barbeque sauce on all meats, beef, venison, pork, poultry, fish, and more! 16 fl. oz. - 128 fl. oz.

### Ultimate Grill Seasoning

Season proteins with that distinctive outdoor grill taste or enhance the fresh off the grill aroma. 6 oz.

### Ultimate Steak Marinade

The search for that perfect marinade is over! Try this one on venison, beef, pork, and poultry! 6.5 oz.

### Sausage and Meat Loaf Seasoning Mix

Remember Morton's Sausage & Meatloaf seasoning? This is a copy of that seasoning, very popular for Pork Sausage! 6 oz.

### Sugar Cure

With seasoning packet - 3.78 lb.

### Quick Tender

Similar to Morton's Tender Quick

Also available 110VAC 12" commercial meat slicer wholesale \$425, retail \$539. 110VAC meat band saw with grinder wholesale \$550, retail \$699 pint, quart, and gallon vacuum bags in boxes of 100. #12, #22, #32 grinder plates in 3mm, 3.5mm(1/8"), 4.5mm, 8mm, 12mm hole sizes. Call for grinder plate and vacuum bag pricing.

## TAX-TIME HEADACHES?



**Start up now and reduce tax-time mess and stress!** Ask for free info about a simple, accurate system that combines your check writing and bookkeeping into one easy step. So easy a smart 10-year-old can do it! Once you use it you'll never go back to the frustrating old way!

No check stubs, no separate ledgers, no copying errors and no missed deductions. At year-end your figures will be all ready to go. No digging through months of records and stacks of bills!

**Already have a One-Write System?** Save money with genuine original or compatible forms. Shocking savings on genuine Deluxe brand products. Will not be undersold on Wilmer brand products. Self-seal envelopes available.

**Savings on first order!** Mention the code at the bottom of this ad and receive a discount, or double check quantity for free, depending on brand!

**I specialize in One-Writes.** I give personal help and answer questions both before and after the sale. Call to discuss which system will best meet your needs. Now is the time to set up to make tax time easy next year.

**Also available,** checks for QuickBooks, Classic word processors, etc. Manual forms, as well as promotional products, are available.

**I speak Pennsylvania Dutch as well as English.**

## 40 Years' Experience with One-Writes!

**Lester H. Beachy, CAS**  
4028 Judith Rd. • Dover, DE 19904  
Ph: 302-492-1060 or 1-888-490-1060  
Hours: 9-4:00 • LesBeachy@aol.com



A fruit is named after it.  
What is it?



Stock and Custom

# HARDWOOD INTERIOR PANEL DOORS

WHOLESALE DISTRIBUTOR OF WOOD PANEL DOORS

## SLIDING BARN DOOR

Hardware and accessories

Large Inventory in Stock!

**Lincoln LLC**  
888.427.0462  
6822 E. Lincoln Way, Wooster, OH 41691  
Fax: 330.804.3333

Call or write for pricing

## Custom Spray Foam Rigs

# NO GENERATOR NEEDED

USS PRO AIR SERIES

**UNICUS**  
SPRAY SYSTEMS

UNIQUE, UNPARALLELED, ALONE OF ITS KIND

USS PRO AIR I - 1 Hose Rig

USS PRO AIR II - 2 Hose Rig

- **NO generator or shore power required**
- **Double the spray output with the USS Pro Air II - 2 hose rig**
- Efficient design uses waste heat from compressor engine to heat foam material
  - Save thousands in annual fuel costs vs. generator based systems
  - Compact and lightweight

Call today  
**Generating Profits without a Generator!**

(414) 353-5250 • [info@unicusspraysystems.com](mailto:info@unicusspraysystems.com) • [unicusspraysystems.com](http://unicusspraysystems.com)  
8648 W. Kaul Avenue, Milwaukee, WI 53225

Excellent Business Opportunity. Let us help you get started.

Have you considered renting your weekend vacation property on **Airbnb** or **VRBO** BUT DON'T WANT THE HASSLE?

Let us do it for you! We offer:

- Daily & weekly professional cleaning
- Pet free & smoke free guests
- Secure keyless entry
- Automatic monthly payments to the homeowner

**Sandpiper**  
HOMESTAYS LLC

**JOHN TROYER JR.**  
5836 Seip Road  
Georgetown, OH 45121  
p: 937.515.9426  
e: [john@sandpiperhomestays.com](mailto:john@sandpiperhomestays.com)

## Introducing Products that Actually Work!!

### Cellular Energy™ Powder & Capsules

Cellular Energy™ powder & capsules contains a certified organic Alpha glycan complex, Peptide Rice. It also includes CoQ10—a great source for healthy energy, rice bran with B vitamins, minerals fiber and healthy oil, and d-Ribose added to complement the nutritional benefits of this formula. Cordyceps is included for energy and to support the immune system as well as many other key ingredients for your vibrant health.

### Joint Support™ Next Generation

Joint Support™ Next Generation helps support exercise regime, is formulated with enzymes, aids the digestive process, and helps maintain healthy joint cartilage.

### Orchard Omegas® Next Generation

Orchard Omegas® Next Generation Experience the highest source of Omega 3 in this vegan formula that supports circulation and promotes breast health.

### Vital HF™ Next Generation

Vital HF™ Next Generation supports the immune system by delivering fulvic acid, a component of humate, and is powered by Vitamin C, Echinacea, garlic, zinc, and much more.

**CONCLIN**

**Wilma Beechy**  
64170 Mckale Road, Burr Oak, MI 49030  
**269-767-5919**

# Have You Considered A Fabric Building?



- Galvanized Steel Structure
- Natural Light
- Excellent Ventilation
- Possible Tax Reduction
- Resale Value



- 24' to 100' wide, any length
- Ventilation options
- End Kits
- Replacement covers for all brands
- Call or write for a free brochure!



## Skylight Fabric Structures

20749 State Highway VV, Ethel, MO 63539  
833-482-8862 | 660-486-3250



# Homestead Equipment

## NEW ITEM REVERSIBLE TRANSPORT DISC

### FEATURES:

- Fifth Wheel located on top of rear discs allows discs to be reversed to level raised beds when plastic is removed
- Spring-loaded pins for easy adjustment of reversible discs
- Spacious platform with safety guard
- Seat Included
- Spring assisted lever for easy depth adjustment
- Sealed Bearings
- Heavy duty 1-inch axels
- 18-inch disc blades (plain or notched)
- Tongue height adjustable with turn buckle
- Angle adjustable on disc

### OPTIONS:

- Short hitch or long tongue
- 1-row of spiked teeth along back for smoother finish

Can be pulled with horses, ATV, or small tractor  
4ft — 5ft — 6ft — 7ft



## CONTACT US TO FIND A DEALER NEAR YOU

### AVAILABLE:

- Cultivators
- Eveners
- Cantilever Racking
- Mechanical Shed Movers
- Cultimulchers
- Forcarts
- Transport Discs



Available in 2' through 10' sizes.  
Recommended:  
One draft horse per 2 ft on larger sizes.



1 Horse Walking Cultivator  
Adjustable Width  
Adjustable Wheel Height

Forecart  
Foot Pedal Steering  
Raised Tongue • Torsion Axle

For Information and Pricing Send your request to:

**HOMESTEAD EQUIPMENT LTD**  
12139 Flemming Road, West Salem, Ohio 44287  
or call Yoder's Produce — 330 695 5900

Ask for your  
**FREE Catalog!**

# HOOVER MAPLE SUPPLIES

**Now thru Dec 31<sup>st</sup>,**  
**Place an order of \$150**  
**or more and receive free shipping**  
(excludes tubing and jugs)

Are you prepared for Maple Season?  
What's on your Checklist?

Sugarmaker's Companion Book.....	\$42	Cone Filter.....	\$12
Backyard Sugarin' Book.....	\$12	Spout - Spouts - Taps - .....	18 ¢ ea
Thermometers - 3"-5" Dial.....	\$45	Complete Sapbag set .....	\$3.50 ea
Tree Tapper Bit.....	\$14	Complete Starter Kit with 10 buckets	
Grading Labels - roll of 500.....	\$6	Tapper bit, Filter, book, thermometer,	
Hydrometers - Sap.....	\$16	12 glass bottles.....	\$.185
Syrup.....	\$12	And much more	

**Tubing Tools  
INSTOCK!**

**YOUR ONE STOP SHOP,  
FROM TAP TO TABLE!**

**FREE Quotes! Give us a CALL! 607-522-4340**

Mahlon & Emma Hoover 2355 Pulteney Road, Branchport, NY 14418



We ship UPS and Truck Freight







269-659-3950  
27539 Londick Rd.  
Burr Oak, MI 49030

7.5 miles north of  
Sturgis, MI via M-66

Introducing the  
"ACTIVE WOMEN'S  
& MEN'S 50+  
85 BILLION PROBIOTIC"

- Helps support the:
- Digestive System
  - Immune System
  - Colon

Call today to ask about our full  
NEW probiotic line!



YOU'RE ON THE GO!  
DON'T LET THE "HAVE TO GO," SLOW YOU DOWN!



# HIGH POWERED CORDLESS BLENDER

Fully DC w/low Battery  
LED + Shutoff  
One year warranty

RUNS FASTER WITH TOOL  
BATTERY THAN ORIGINAL  
ELECTRIC



GREAT  
*Christmas* GIFT

Imagine Machining  
3491 Pine Mountain Road  
Jersey Shore, PA 17740  
570-745-3320

CALL FOR QUANTITY PRICING

## DEALERS

- |   |  |
|---|--|
| Badger Tools & Supply - Hillpoint WI. 608-986-2373    | Kings Tool & Supply - Dover DE. 302-632-7599         |
| Bontragers Shop - Jamesport MO. 660-684-6933          | Lengachers Small Engine - Keosauqua IA. 319-293-3754 |
| Cardinal Hollow Repair - Quarryville PA. 717-786-3801 | Millers Dry Goods - Fountain City IN. 765-847-5003   |
| Creative Power Celutions - Topeka IN. 260-350-4720    | Mohican Hardwoods - Danville OH. 740-599-5080        |
| Elmsport Supply - Allenwood PA. 570-547-2081          | Oak Ridge Furniture - Jamesport Mo. 660-684-6558     |
| Hillside Supply - Fillmore NY. 585-567-4662           | Sunrise Sales - Rockville IN. 765-592-6255           |
| Kauffmans Treasures - Orwell OH. 440-437-3600         | Sunset Appliances - Topeka IN. 260-593-2384          |
| Kings Coutry Store Nathalie VA. 434-349-9425          | West Bench Country Store - Roberts MT. 406-445-2197  |

## Want to cut your fuel bill in half?

The **COBRA DHC 2000** welding and cutting torch is just what you need!

The mixing chamber is unique in that it mixes oxygen and acetylene gas in EQUAL volumes and pressures (4psi). In doing this, the flame is very concentrated and burns more efficiently producing a hotter flame, prevents warping & saves both fuel & time.

\$10.00 OFF  
THROUGH  
DECEMBER



\$449.00

MADE IN  
THE USA  
SINCE 1982

\$569.00

FREE  
SHIPPING

**Standard Kit** includes:  
Torch Gun, Tip, Cutting #0 #1 #2 #3 #0.5  
Tip Cleaner, Wrench & Check Valves  
Over Cutter Attachment &  
Under Cutter Attachment  
Instruction Manual & Instructional DVD

**Deluxe Kit** includes:  
Standard Kit +  
• Air Acetylene Tip  
• Curved Extension  
• Straight Extension  
• Tips: #00 #1.5 #2.5

## LIFETIME WARRANTY

### CUTS LIKE A PLASMA AND WELDS LIKE A TIG

A lot of people ask what we can do and so forth, so here are a few things it can do. You can weld up to a 3/8" steel on one side, our #3 tip is kind of a heating tip and welding both. It works great for thick cast iron. Or dressing horse shoes. Our #0 is for welding eyeglasses or really small stuff. Our cutting is different to our over cutter cuts from 1/8" to 1" steel and our undercutter cuts .04 up to 3/16". These cutters are only for steel. And it's cuts look like a plasma cuts, sharp and clean. If there is slag it pops right off when you hit it with a sharp edge.

The welding part, we use all tig rods. You can weld stainless steel, cast iron, brass, copper, aluminum, h-steel, silver soldering, steel.

We also have low pressure gauges with with a lifetime warranty

WHOLESALE INQUIRIES  
WELCOME

For more information or orders write Note our new address:

**SCHWARTZ WELDING EQUIPMENT, LLC**  
1161 S 200 W • Monroe, IN 46772 — Include phone number for call-back

# PENN DIESEL SERVICE CO.

**Diesel are what we know best!**

Diesel fuel injection \* turbocharger \*  
engine parts distributor since 1952

All AG/Industrial pumps & injectors have  
2yr/ 2000 hr limited warranty

Free shipping via UPS.

Call and let us arrange pickup

800-535-2913

[www.penndiesel.com](http://www.penndiesel.com)

For Earth, For Life







*We've Moved!*

**When?** .. Late June through July and August (Lord Willing).  
**Where?** .. Walker Missouri (Harwood Community).  
**How?** ..... A lot of trucks, elbow grease, and patience.

**We hope to reopen in late September or October.  
Thank you for your patience.**

*We plan to continue manufacturing quality attachments for skidders and tractors in our new facilities in Walker, MO.*

*A special Thank You to all of our customers, we hope to continue serving you in years to come.*

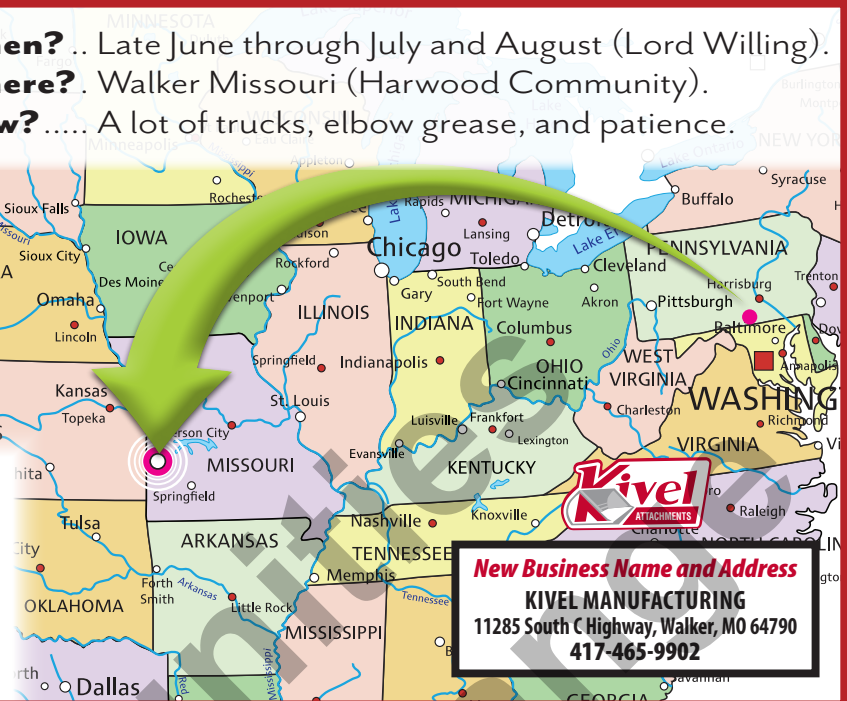

**New Business Name and Address**  
**KIVEL MANUFACTURING**  
11285 South C Highway, Walker, MO 64790  
417-465-9902

## Water Heaters for Every Need



### YOUR ENTIRE HOUSE ... OR BARN

#### EZ Deluxe-

- Direct Vent tankless water heater designed for 1-2 Bathroom Homes
- 4.4 GPM at 35f Temperature Rise
- Concentric Direct Vent Kit (included with purchase) MUST be used horizontally
- 82,000 BTU
- 31 lbs.
- 25.6" x 13.6" x 6.5"
- 110V
- 1/2" Water and Gas connections

**\$535.00**

#### EZ UltraHE-

- Condensing tankless water heater designed for 1-2 Bathroom Homes
- 4.4 GPM at 35f Temperature Rise
- Condensing Technology raises efficiency
- Can be vented vertically or horizontally up to 30 feet using 2" schedule-40 PVC
- 70,000 BTU
- 31 lbs. - 27" x 14.5" x 6.5" - 110V
- 1/2" Water and Gas connections

**\$645.00**

#### EZ Supreme-

- Direct Vent tankless water heater designed for 1-3 Bathroom Homes
- 8 GPM at 35f Temperature Rise
- Concentric Direct Vent Kit (included with purchase) MUST be used horizontally
- 165,000 BTU
- 47 lbs.
- 25.6" x 14.5" x 7.5"
- 110V
- 3/4" Water and Gas connections

**\$839.00**



*Great Christmas Idea for men and boys.*

**Complete Kit on Wheels!**  
Great for: •Horse Sales •Buggy Wash  
•Dog Kennels, and Much More

*\*Additional shipping costs may apply.*

#### EZ101 PORTABLE

Very similar to the EZ202 with half the capacity.

**\$175.00**

*Runs on D batteries, no electricity needed!*

#### EZ202 PORTABLE TO SEMI-PERMANENT

- 4.0 GPM @ 35 degree temp rise
- 84,000 BTU
- 1/2" water & gas connection
- D Battery Ignition
- 27.5" x 14.5" x 5.5"
- 24 lbs.

**\$349.00**



#### EZ PRIME MODEL

- 5.5 GPM @ 35 degree temp rise
- 110,000 BTU
- 1/2" water & gas connection
- 110 Volt Ignition (0.3 Amp while running)
- 22" x 13" x 5"
- 31 lbs.

**\$293.00**

**Stoney Ridge SALES**

3563 Mahantango Creek Road  
Dalmatia, PA 17017

**717.979.5005**

*Free Shipping Nationwide*

## JOHN DEERE HIT & MISS ENGINE WITH ICE CREAM FREEZER



Complete Unit

1 1/2 HP John Deere  
with 20 qt. Freezer

**John Deere Hit & miss Engine parts, Country Ice cream Freezers and Parts**

### SCENIC VIEW ENGINE, LLC

5673 County Road 59 • Millersburg, OH 44654

**330-674-2450**

*Contact us for free brochure!*

ScenicViewEngine@ibyfax.com

*We restore John Deere and other engines*



Kit - To Build Your Own Unit



## CHANGE YOUR GAS LIGHTS TO LED

### New Wall & Ceiling Mount Battery Lights

# Tranquil Lights

A Product of Mid Ohio Lighting

1 year warranty

Need a Christmas Gift?

**BEFORE (GAS)**



**AFTER (BATTERY)**



**Simply unscrew your gas light and install your Tranquil light**

- Black Finish
- Battery mount fits Dewalt, Makita or Milwaukee Battery
- Fits standard 1/2" Gas pipe
- Wall or Ceiling Mount

Also now available 8-1/2" lights. Works great in tight spaces. Bathrooms, Etc.

**\$99.95 + Free Shipping**

Mid Ohio Lighting - PH: (330) 600-7442

## Are you looking for more *Energy, Clarity, & Focus* or looking to *Lose Weight*?

Supports ...

- Focus
- Blood flow
- Fat to muscle
- Fat to energy
- Weight management

*May stimulate focus & motivation  
Provides support for rapid, prolonged energy and much more*



**sisel**

**LIFE IS A SPORT**

*Results are amazing*



*Sisel Starter Pack*



*Sisel Starter Pack Plus*

Supports ...

- Keto diet
- Fat burning
- Diminished cravings
- Appetite suppression
- Weight management
- And much more

CALL TODAY for FREE information

Wayne & Becky Hershberger

5711 Girdle Rd | West Farmington, OH 44491

Ph: 330-889-2111



**Portage & Main**  
Outdoor Boilers

Quality and Innovation Since 1931!

PortageandMainBoilers.com



**POLAR FURNACE**  
Clean, simple heating with wood

PolarFurnace.com

**The industry leader in proven clean burn technology**

- ✓ Cast refractory construction
- ✓ Heat free with your forest waste
- ✓ Oldest renewable energy
- ✓ Free installation support w/purchase

**All Fire,  
NO  
SMOKE!**

**Simple to operate**



**Ultimizer Coal Shaker Model**

- ✓ Chip burner
- ✓ Coal and pellet burner
- ✓ Call for a dealer near you

**Easy to maintain**



**Polar G-Class**

- ✓ Burn up to 60% less wood
- ✓ 7 industry firsts
- ✓ Certified indoor/outdoor install

**26%  
TAX CREDIT**

ASK US FOR MORE DETAILS

**POLAR G3 & G2 PLUS**

NOW AVAILABLE 3/16" thick 304 Stainless Steel

**HUTTERITE BUILT**



**UltimateOutdoorFurnace.com**

Les Radcliffe, Polar Furnace Factory Representative  
507 254 0622 | lesradcliffe@yahoo.com

DEALERS  
WANTED



**COUNT ON IT**

# EASE of USE

## TWIN LEVER STEERING

- Financing Available
- Affordable Shipping Available



ladies this is for you!





STAND ON ATTACHMENT



DUMP BED ATTACHMENT

- ★ Drive with ease! Easy-to-learn twin-lever controls
- ★ Easy height of cut adjustment
- ★ 20" drive tires
- ★ Powerful Kawasaki electric start engines
- ★ Available in 36", 48", 54" and 60" decks
- ★ High velocity decks also work great in pastures

SEE OUR FULL LINE OF OUTDOOR POWER EQUIPMENT

Apple Creek, Ohio | **330-698-0229**





# FIRE PRO

A Must Have For Barns, Welding & Mechanical Shops, Saw Mills, Combines, Choppers, Hay Balers, And Many Other Applications

The most powerful fire extinguisher choice for the agricultural world and much more!

Quantity Discounts



Fire Pro Advantage

1. **EASY RECHARGE!** to recharge your empty Fire Pro, simply call us and we will send you a Fire Pro refill kit, letting you do your own refills! Saves you money and lots of time.
2. **KNOCKS DOWN FLAMES AND KEEPS THEM DOWN!** uniquely designed Fire Pro cooling liquid penetrates deeply into hot surfaces and quickly pulls heat from fires, along with foam taking oxygen away from fires.
3. **HIGH VOLUME** 2.5 Gallons of NON-Toxic Fire Pro Mix with the ability to fight huge, hot fires fast with a discharge time of 50 sec and a super far spraying distance of 50 feet!
4. **REFLECTIVE STRIP** Helps you find your extinguisher quickly, when your life and or property is depending on it.
5. **CAN BE USED MULTIPLE TIMES**

Liquid Based With foam

Live Demos Available

**WITHOUT RECHARGE**, Recommended to recharge after Gauge falls into red.

**6. STAINLESS STEEL CANISTER** for many years of dependable service

**7. DOESN'T FREEZE!**

**8. FOR USE ON TYPE A-B-K FIRES**

**9. EXTINGUISHING AGENT** doesn't settle in Fire Pro fire extinguishers, or leave expensive messes, or Damages.

**Don't let the cure be worse than the actual problem!**

**BUY FIRE PRO! BE PREPARED YOUR LIFE AND PROPERTY COULD DEPEND ON IT!**

Call Us Today For Questions and Orders  
715-271-8963

Address: Fire Pro, N12171 St. Hwy 73, Owen, WI 54460

Prices Subject To Change Without Notice

Pricing: New Extinguisher \$ 268 with Free Shipping

Pallet Machinery  
Sawmill Machinery  
Custom Machinery



6700S Single Head Notcher

\*optional hydraulic\*



717.354.4348

800.233.0A71

WWW.Pendu.com

Get those milk quality bonuses you deserve!



By applying Superior Cow Cream (SCC) on your high cows quarters, you can lower your herd Somatic Cell level.

For stubborn cases, use Yellow Jacket Teat Tonic and Mas-tic Udder Oil.



FREE sample of Mas-tic for NEW customers only!



Synergy Animal Products, Inc.  
1681 Schubert Rd, Bethel, PA 19507  
1-800-507-9361

AUTOMATIC, FROST-FREE WATERER



THE ULTIMATE

5 YEAR WARRANTY!

STAINLESS STEEL SET SCREW TO ADJUST PADDLE TENSION

SCALLOPED EDGES TO PREVENT OVERFLOW

1/4"- 20 METAL THREADS IN BOWL TO SECURE PADDLE

HUGE STAINLESS STEEL BOLTS

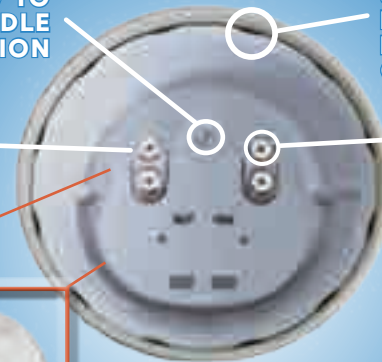

SNOWFIN TO PROVIDE ADDED PROTECTION IN EXTREME FREEZING RAIN AND SLUSHY CONDITIONS

1/4" STAINLESS STEEL AXLE

CALL US TO FIND YOUR LOCAL DEALER: 844-311-POST (7678)

www.DrinkingPost.com

# Helping People Help Themselves



Salt Microfinance Solutions - a program of Christian Aid Ministries



## SALT Members Become Part of the Solution

As SALT savings group members gather in their weekly meetings to save money, they also learn and practice the concept of helping their own people. This is practiced by having a social fund within their savings group.

The social fund is similar to the alms fund many of our churches use. As savings group members are able, they deposit money into this social fund in addition to bringing their weekly savings. When the group is ready to close out their accounts and reorganize into a new term at the end of the year, the social fund balance is usually used to help with a need within the group or community. The group decides how the fund should be used.

Week after week, this offering money grows slowly but surely. One newly formed savings group from Ghana was surprised and excited to see how much funds they had accumulated at the end of a year. The members agreed to use the funds towards building a new church house. They were able to build their church house using their own contributions, allowing them to be less dependent on funds from America.

The social fund is a very effective teaching tool in savings groups. It empowers members in a way they never dreamed possible. In the past, they believed that outside intervention such as funding and material aid from America was the only way their social situation could improve. Now these SALT members are beginning to realize their own abilities. With God's grace and each other's help, they can make a difference in their communities.

One savings group in Haiti is using its social fund to ambitiously take on a water piping project. As funds continue to accumulate, they are building a water reservoir a half-mile uphill from their village. They are installing a pipe from the reservoir down to the village, where people can use the water to irrigate crops. This project will benefit not only the

savings group members but everyone in the village.

For major projects like this, Haitians are generally accustomed to depending on mission groups or government agencies to supply funds, equipment, and labor to meet their needs. They also generally look to the agencies for continued upkeep of the system. But by working together to raise funds and utilize their money to benefit their communities, they are learning they can help their fellow Haitians.

In many developing countries, a person who needs to go to the hospital is required to provide their own personal items such as soap, toothpaste, and other toiletries. One savings group from Nigeria used their social fund to purchase and distribute care packages in the local hospitals. This gave them the opportunity to pray with the hospitalized patients.

All over the world, SALT members are learning the discipline and joy of giving. Many of them have personal financial situations that are less than ideal, yet they are willing to help others in need. **They are learning to become part of the solution instead of the problem.**

In this season of giving, the SALT members' generosity challenges our own faith and commitment in following Jesus' teachings. As we approach this new year may we look beyond ourselves by serving Christ and others. One SALT Agri-Plus member from Ghana who is also the village chief shared, "I am very happy and thankful for the opportunity given to my community to benefit from SALT Agri-Plus."

May many people benefit from the generosity of their fellow man as they demonstrate the love of Jesus, even in the most remote areas of the world.



# Testimonies from SALT members in Namibia

Here are several testimonies from SALT members in Namibia, a country along Africa's southern coast.

## “We have learned God’s desire for us to live holy lives”

This group of savings group members in Namibia shared, “SALT teachings have changed our lives and opened our eyes to the truth. We have learned God’s desire for us to live holy lives—something we did not realize before. Because of this truth we can testify to the world of our faith in Jesus. . . . We thank God for opening this door for us.”



## “I surrendered my life to the Lord”

Fransina was forced out of her parents’ home to live with the father of her second child. He eventually abandoned her. With no one to care for her needs, Fransina struggled with suicidal thoughts.

The SALT facilitator encouraged Fransina to return home and amend things with her family. He also spoke to her about forgiveness, divorce, and other teachings. Fransina said, “I realized I was in sin, asked God to forgive my sins, and surrendered my life to the Lord. He is carrying my burden since then.” She continued, “I started praying and reading my Bible which was given to me. . . . I can’t stop praising the Lord for what He has done in my life. Now, I am employed. I can support my children and save in our savings group.”



## Questions and Answers

### Question:

Many are expressing concern about the current trend of going cashless. Is that something that infringes on our Christian beliefs, or what is the reason for the concern regarding a cashless society? Other than actual mined metals such as gold or silver, are not all forms of payment a similar transaction of money being transferred based on trust?

### Answer:

In the past few years there has been a tremendous interest in digital currency and the ability to transfer money electronically. And as you have noted, this has instigated many discussions and concerns. What is this leading to? Is moving to a cashless society a good thing? As with most innovations, there are both advantages and disadvantages, and sometimes the drawbacks are not apparent until long after the change has been embraced. Let’s look at some of the pros and cons of being able to hold and transfer funds digitally.

One advantage is that money held electronically, usually on a mobile phone, is difficult to steal. This is a huge benefit for peo-

Q&A with Gary Miller - Continued on Page 197

### Would you like to support SALT Microfinance Solutions?

If you wish to help provide sustainable solutions for those living in poverty, use this response coupon to make a contribution.

#### ONE-TIME DONATION

#### SALT Microfinance Solutions (ML):

Helps people in material poverty provide for their families through microloans, savings groups, vocational training, agricultural programs, and Christ-centered teaching.

- |                                   |                                   |                                      |                                  |
|-----------------------------------|-----------------------------------|--------------------------------------|----------------------------------|
| <input type="checkbox"/> \$25     | <input type="checkbox"/> \$50     | <input type="checkbox"/> \$100       | <input type="checkbox"/> \$250   |
| <input type="checkbox"/> \$500    | <input type="checkbox"/> \$1,000  | <input type="checkbox"/> \$2,500     | <input type="checkbox"/> \$5,000 |
| <input type="checkbox"/> \$10,000 | <input type="checkbox"/> \$25,000 | <input type="checkbox"/> Other _____ |                                  |

- Check here if you DO NOT wish to have a receipt.  
 Check here if you wish to have only a year-end statement.  
 A receipt will be sent unless otherwise noted.

#### Ways to donate:

- Make check payable to Christian Aid Ministries and mail to P.O. Box 360, Berlin, OH 44610
- Call 330.893.2428 to donate by debit/credit card

#### Your name and address:

Name \_\_\_\_\_  
 Address \_\_\_\_\_  
 City \_\_\_\_\_ State \_\_\_\_\_ Zip \_\_\_\_\_

- Please sign me up to receive the quarterly SALT Microfinance Solutions newsletter PCBE



## About Billboard Evangelism:

CAM's main vision for Billboard Evangelism is to make people stop and think about God, their relationship with Him, and eternity. Gospel messages on billboards provide the perfect opportunity to direct commuters' thoughts to God. Our purpose statement is found in Acts 26:18: *"To open their eyes, and to turn them from darkness to light, and from the power of Satan unto God, that they may receive forgiveness of sins..."*

### Caller quotes:

"I don't know how to pray." —*Wisconsin*

"I feel God calling, and I don't know how to respond." —*New York City*

"Where can I go if I'm spiritually disconnected from God? Can you tell me?" —*North Carolina*

"I've been meditating and praying every day." —*New York City*

"I saw the billboard, *Where are you going? heaven or hell.* What is that? Is it a place?" —*Unknown location*

### 1,245 billboards spreading the Gospel in the U.S.

Includes bus/mall posters in four states that ban billboards.

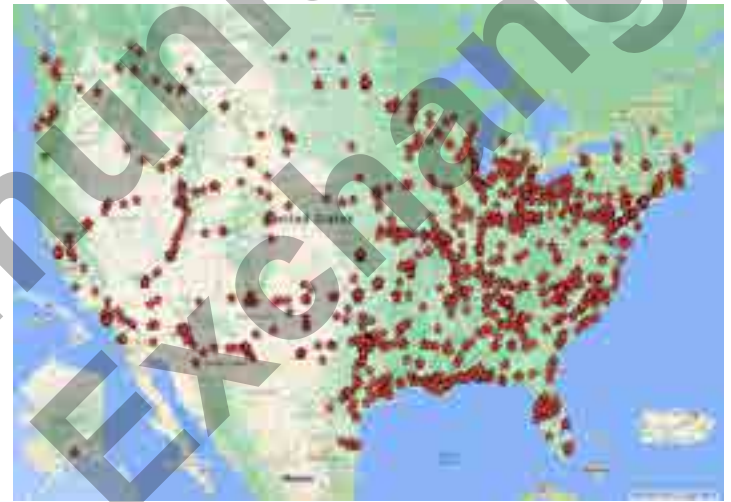

### Bible reading frequency among adults in the USA

- 30% never
- 12% less than once a year
- 10% once or twice a year
- 8% once a month

*statista.com*

## Three callers—three attitudes

**Matthew\* called from California** and said, "I don't know how to be alive." He is almost thirty-five years old, sits in a wheelchair, and smokes cigarettes all day. Six years ago, Matthew attempted suicide by jumping off a bridge. This resulted in a year's stay in the hospital and the amputation of one leg. He realizes he is not living in victory over sin. He has much anger toward himself, his mother, and the world in general.



Our team member urged Matthew to humble himself and be honest with God. "Confess your sins to God," he said. "Accept the pain caused by your choices, your mother, and the world. God will give you grace if you humble yourself and seek His face. He who humbles himself will be exalted."

**Angela is in her fifties and had been a professing Christian all her life.** She was a missionary to Africa and knew the disciplines of praying and fasting. She saw miracles. But now she has fallen into discouragement and bitterness because of the many problems that have returned to haunt her. She was abused by her sister when she was four years old. Then she was abused again, this time by her boyfriend. They were counseled to get married, but it didn't go well. They had twin boys, and then she divorced her husband. Now her boys are grown, but they won't have much to do with her. Angela has a medical condition that won't allow her to eat anything but greens and meat. She has a plugged drain in the bathroom that she can't fix. She hired a contractor to paint her house, and he left it half done. Her pastor made a comment about her work in Africa that felt like it was minimizing her importance in the work there.

Our team member told Angela that he can't give her a solution to her problems. "Even if I could fix one of them, the other problems would all still be there," he said. "But I can tell you where freedom can be found. That is in a truly grateful spirit. 'In everything give thanks: for this is the will of God in Christ Jesus concerning you' (1 Thessalonians 5:18)."



ple living in extreme poverty and explains why digital currency is so popular in Africa. Carrying money is dangerous, and electronic transfer by phone greatly reduces the risk of theft. There simply isn't anything tangible to steal, and with every transaction tracked, a robber is easily traced. Another advantage is that, when an unexpected catastrophe occurs, poor families can quickly receive transfers from family and friends, even though they live far away.

There are also disadvantages. Electronic exchange makes you vulnerable to data breaches and more susceptible to identity theft. Privacy is a huge concern here in America, and the more we utilize electronics, the greater our exposure to loss of privacy.

Cashless systems are not really a new idea. The barter system, which is as old as history itself, is a prime example of a cashless system. However, exchanging a few chickens for firewood seems different than transferring money by phone. Something about money being held in binary form on a computer out there seems very vulnerable! But maybe God is using this cultural shift to remind us that this world isn't a safe place to store our money.

As you noted, other than utilizing gold or other precious metals, our entire system is based on trust, and perhaps trust is the issue we should be focusing on. What are we trusting in? Is finding the safest and most trustworthy place to transfer and store our resources our greatest concern? Perhaps, more than ever, it is time to listen closely to Jesus'

words: "Lay not up for yourselves treasures upon earth, ...but lay up for yourselves treasures in heaven:" (Matthew 6:19-21)

Perhaps the Lord is calling us to a different kind of transfer and a safer storage place. If you really want to ensure your resources are safe, Jesus said to give to the poor. When we do this, we are investing in a sure investment, "a treasure in the heavens that faileth not, where no thief approacheth, neither moth corrupteth." (Luke 12:33)

That sounds like the ultimate instant eternal transfer!

We would like to know your questions for future issues. To submit a question, write to: Gary Miller % PCBE PO Box 520, Millersburg, PA 17061, fax 717.427.1600 or email editor@plaincommunities.com. We reserve the right to use or omit any submitted question in future columns. Answers given in this column do not necessarily reflect CAM's position on the topic.

To receive CAM's free quarterly **SALT Microfinance Solutions** newsletter, contact us at this address or phone number: Christian Aid Ministries | P.O. Box 360, Berlin, OH 44610 | 330.893.2428

**Daryl has had his share of problems.** He used to be on drugs and, not long ago, he was homeless. Recently he was in an accident with a garbage truck and was laid up for at least three weeks. But Daryl wasn't calling to talk about his problems. Instead, he was bubbling over with all the good things God had done for him. He was so thankful for a one-hour phone call he'd had around two years ago with our phone team member Howard. Before that phone call, he had been on drugs, and was homeless, but on that call he chose to give his life to Jesus. Now he has a home and isn't on drugs any more. He found a job with the city of San Antonio, Texas—a job where he can show the Jesus' love by helping people with their housing needs. "It is a privilege to be able to serve God in this way!" he said. He is overflowing with the blessings God has given him over the last two years. He talks regularly to one of our other phone team members whose wife has cancer. Daryl gives her name as a prayer request every time his church has a prayer meeting. He just wanted to let us know what a blessing the billboard ministry is, and that people really are coming to the Lord as a result of it. And Daryl is an example of that.

**Where are you?** Do you lack forgiveness like Matthew? Do you need gratefulness like Angela? Or are you bubbling over with thankfulness like Daryl?

\* Names changed to protect identities.

If you would like to support the **Billboard Evangelism** program, please see the response coupon.

If you would like to support the **Billboard Evangelism** program, please use this response coupon to make a contribution.

**ONE-TIME DONATION (BBE)**

YES, I want to help display Gospel messages throughout America.

\$50  \$100  \$250  \$500  \$1,000  \$5,000  \$10,000  Other \$ \_\_\_\_\_

**MONTHLY SPONSORSHIP (BBE)**

YES, I intend to give monthly donations to help CAM put Gospel billboards along interstates and major highways.

\$50 monthly  \$100 monthly  \$500 monthly  \$1,000 monthly  \$\_\_\_\_\_ monthly (any amount)

I prefer to give for one year at a time (12 months).

\$\_\_\_\_\_ x 12 = \$\_\_\_\_\_ total

(You will receive a donation reminder when your year is up.)

Each monthly sponsor will receive the **Billboard Evangelism** quarterly update and a phone team prayer card.

- Please send me information about sponsoring a specific billboard through the *Adopt-A-Billboard* program.
- I would like to receive the FREE quarterly *Billboard Evangelism* update.

**Ways to donate:**

- Make check payable to Christian Aid Ministries and mail to P.O. Box 360, Berlin, OH 44610
- Call 330.893.2428 to donate by debit/credit card

Check here if you DO NOT wish to have a receipt.

Check here if you wish to have only a year-end statement. **A receipt will be sent unless otherwise noted.**

**Your name and address:**

NAME \_\_\_\_\_

ADDRESS \_\_\_\_\_

CITY \_\_\_\_\_ STATE \_\_\_\_\_ ZIP \_\_\_\_\_

PCBE



## Tubular Skylight

High-Impact UV-stabilized Acrylic Dome

One-Piece Seamless Aluminum Flashing

Stock sizes to choose from:  
10" - 13"  
18" - 21"

98% Reflective Aluminum Tube

Aluminum Trim & Decorative Rings

UV-stabilized Dual Layer Diffuser

We ship UPS

ANY dark room you can possibly think of, big or small, can have beautiful natural DAYLIGHT with ELITE Tubular Skylights!

## PANELING SALES

143 Belmont Road, Gordonville, PA 17529 • (717) 768-8037

Peace on earth will come to stay, when we live Christmas every day.

~Helen Steiner Rice

## NIGHT EYES

GREAT FOR NIGHTLY CHORES!

### HL50 HEADLAMP

- Super bright dual-white LED headlamp
- Brightness is comparable to the high-beam of a vehicle's headlights
- Adjustable brightness w/memory
- Hidden strobe, SOS and flash modes
- Weighs 10 ounces with batteries
- Run time from 4 to 80 hours depending on brightness mode
- Low battery warning • Weatherproof design • Rechargeable

Also available for purchase:

- \*\* Battery packs for extended run times (sold separately)
- \*\* Red, yellow and green color pop cap filters (sold separately)
- \*\* D/C 12v charge adapter (sold separately)

Kit includes: LED Headlamp w/adjustable headband, (2) rechargeable Li-ion batteries, AC charger and instructions

### ADDITIONAL HEADLAMPS & PREDATOR HUNTING LIGHTS

#### HL50-Q HEADLAMP

- Twin head design (one beam red or green, the other white)
- Ideal for chores and hunting
- Bright Cree LEDs
- Adjustable brightness w/memory
- Weighs only 7 oz
- Rechargeable

#### GL-350 GUN LIGHT

- Illuminates target at over 350 yards
- Attaches to scope/gun in seconds
- Dual-mode silent remote switch
- Waterproof & shockproof
- Halo shield included-Rechargeable

#### HS-3 SCAN LIGHT

- Three colors in one light
- One button color change
- Adjustable brightness w/memory
- Eye reflection 300 yards at 50%
- Up to 37 hrs of run time - Rechargeable

#### HLO8 HEADLAMP

- Fully adjustable brightness
- Eye reflection 300 yards at 50%
- 8.5 hrs run time on 50% brightness
- Halo shield included
- Weatherproof design-Rechargeable
- Weighs only 6 oz w/battery
- Available in White, Red or Green beam color

Dealer Inquiries Welcome

## NIGHT EYES

NIGHT EYES • 113 E. CHURCH ST. #520 • CENTRE HALL, PA 16828  
814-364-9660 • www.NightEyesLights.com

## HAVING SPINE OR JOINT PAIN?

CALL TODAY FOR A FREE IMAGING REVIEW

662-803-3389

Travis Clegg, MD — Board Certified Orthopedic Surgeon  
S.Allison Feider, ANP-BC — Orthopedic Surgery

### MINIMALLY INVASIVE JOINT REPLACEMENTS

Robert Blok, DO, FAOAO — Board Certified Spine Surgeon  
Mohammad E. Majd, MD — Board Certified Orthopedic Spine Surgeon  
Norman Silva, PA — Orthopedic Spine Surgery

### MINIMALLY INVASIVE SPINE SURGERY

LOCATED IN: Louisville, Kentucky and New Albany, Indiana







# Grillo

## Original Italian Tiller

Your choice of **Honda, Kohler, or Yamaha** engine to power your **Grillo Tractor**

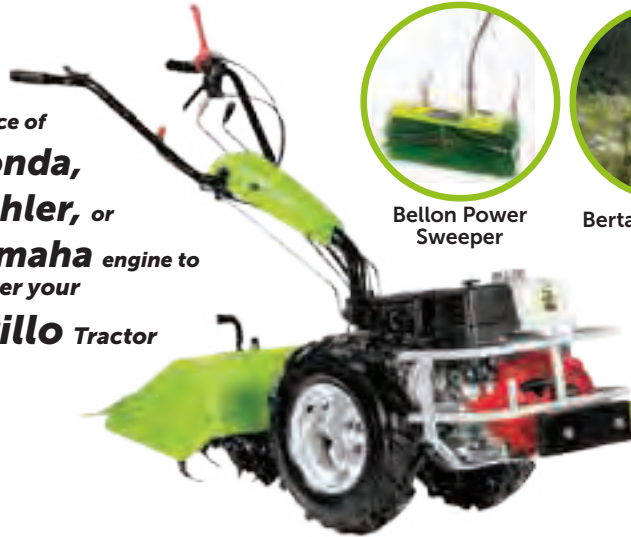

Bellon Power Sweeper



Berta Flail Mower



Berta Snowblower

### ⚠ NOTICE ⚠

NO sickle-bar should be run at full engine throttle; Single-action bars should not be run over 1/3 throttle and Double-action bars not over half-throttle, to keep tractor, blade & operator fatigue at a minimum... and no more power than a sickle-bar consumes, you certainly don't need the power of 'full throttle' anyway! Save fuel, save maintenance cost, and keep the throttle LOW when running a sickle-bar mower!!

- Manufactured in Italy
- User service friendly with high quality construction
- Simple Design
- Active Clutch-single lever clutch control
- Better priced than competitive brands

Call dealers below for pricing and more info!

**Clement Martin**  
C L Martin Small Engine  
Hagerstown, MD  
**301-331-5872**

**Linford Horst**  
Echo Meadows Repair  
Eubank, KY  
**606-341-4403**

Most of our implements will fit BCS

Contact Clement for any engine parts

## ULTIMATE GRADER

### Get rid of potholes and save money on gravel!

- Fits on any skid steer or tractor with Quick Attach
- Gets rid of potholes
- Save money on gravel and enjoy a SMOOTHER DRIVEWAY
- Blade is adjustable with hydraulic

• We now offer three sizes 72", 78" and 84"  
**NEW FEATURE:** Blade is now adjustable for depth with hand crank on pivot point side, opposite of hydraulic cylinder.

For pricing on the product call a dealer...

Ervin Hershberger  
Stotts City, MO  
417-285-6749

Jacob Graber  
Spencerville, IN  
260-750-4332

NEO Equipment  
Newbury, OH  
440-823-1562

Benton Plow Parts  
Penn Yan, NY  
315-536-3807

All Around Building Supply  
Menno Hochstetler, WI  
715-391-0215

For more information about the product call

**Matthew Burkholder**  
440-321-1084

Harvest more business by increasing your advertising coverage...

# PCB EXTRA



... ask about advertising in the PCBExtra.  
Call 717-362-1118

### Ink and Toner

- ✓ Brother, Canon, Epson, HP & more
- ✓ Competitive prices on OEM & aftermarket cartridges
- ✓ Top notch aftermarket products for low print costs and good print quality
- ✓ Quantity breaks = Free Shipping options



- ✓ Time Clocks
- ✓ Email Keyboards
- ✓ Paper Shredders
- ✓ Word Processors



---

### Print - Copy - Fax - Scan

From the home user to the busy office, we've got you covered. Give us a call, we stock them all!

Ask about our email printing and fax services. No phone line required!





1793 Weaverland RD East Earl PA 17519

(Phone) 717-445-0408  
(Fax) 717-445-0774





## YOUR ONE-STOP SHOP

FOR...



Vaccines,  
Wormers,  
& Syringes



Breeding  
Supplements



Toys &  
Treats



ID Collars  
& Microchips

...AND MUCH MORE!

For Info or to Order:

Dale (sales): 812-259-2900  
Email: Sales@blueribbonvets.com

Office: 812-787-2053  
Email: Nicole@blueribbonvets.com



All orders placed by 1pm ship the same day!

# FORMALDEHYDE FREE COATINGS FOR ANY OCCASION



Call Us Today & Ask About Our Line of Formaldehyde Free Coatings  
260.768.3220

# ANNOUNCEMENT

## BRISTOW FARM and BROADHEAD COLLARS

ARE PLEASED TO ANNOUNCE

**BROADHEAD COLLARS**

will become a **Primary Distributor** for  
**BRISTOW FARM'S UNIVERSAL EQUINE DEWORMER!**

**Dealership Inquiries for this 100% Natural  
Equine Dewormer are WELCOME.**



**A PROVEN, SAFE, EFFECTIVE and PRICED RIGHT SOLUTION  
for PARASITE CONTROL in all EQUINES**

**CONTACT**

**BROADHEAD COLLARS**  
17607 200th St., Bloomfield, Iowa 52537  
**Phone: 641-722-3044**



## Custom Nameplates

# identiGROW™

Identify your products. Grow your business.

FREE samples  
and information!



Jon Wendell



Call Today!  
540.283.9193

identiGrow  
PO Box 50  
Port Republic, VA 24471  
sales@identigrow.com  
www.identigrow.com

PC2112

NEW! Full Color Plates - Made to Last!

## WEDDING STATIONARY

BY INKSCAPE

- Invitations
- Fabric Cards
- Songs Sheets
- Thank You Cards
- Programs
- Favors
- & More

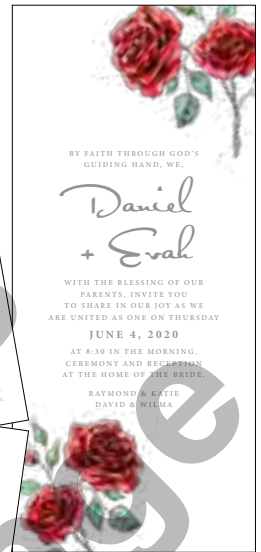

**InkScape**  
Print and Promos

4665 US Route 62 | Millersburg, OH 44654  
sales@inkscapeprint.com

330-893-0160

CALL FOR A FREE CATALOG



## NEW Barbuster Supreme

1000 Denier Outer Shell  
Smooth Quilted Liner  
S.S. Hardware  
Stretchy Leg Straps  
Shoulder Gussets  
Tail Flap



Collar Pads



Long Pad w/Spine Reliever



Breast Collar Pads



Calf Blankets



Lap Robes

Shop your local harness  
shop or contact



Horseshoeing & Harness Shop, LLC  
VM 574-825-8161

WHOLESALE ONLY

DEALERS  
WELCOME

**Mid-River Sales**

10348 County Rd. 18  
Middlebury, IN 46540  
(574) 825-9253 • Fax (574) 825-9808

## PICTURE IT ENGRAVING

We make gift giving easy!



CORPORATE GIFTS, CUSTOMERS GIFTS, EMPLOYEES GIFTS, VENDORS GIFTS

### CORPORATE GIFT OPTIONS

Many businesses are interested in gifting employees or customers with customized items. We're very experienced with adding company logos and slogans to our products, available in high volume purchases. Some of our most popular gifts for businesses are engraved tumblers, cutting boards, and coffee mugs.

### WE'LL ENGRAVE ANYTHING

Maybe you've already found the perfect gift, and now you want to take it to the next level with a custom engraving. No problem! Picture it Engraving offers custom engraving on just about any item you bring in. If you'd like to see a proof of what your custom engraving would look like, you can Request a Mockup.

### GIFTS THEY'LL ACTUALLY USE

Let's face it — when it comes to gift-giving, there's a lot of room for error. Whether you're buying at the last minute, trying to come up with a great idea for the person who already has everything, or worried about giving a poor-quality gift, the fear of looking like a terrible gift giver is real. Picture it Engraving offers one-of-a-kind gifts that never disappoint, no matter who you're shopping for.

### Quantity Discounts

10-24 Pcs - 20% Off  
25-49 Pcs - 25% Off  
50 Plus Pcs - 30% Off



232 Dover Road NW  
Sugar Creek, Ohio 44681

Phone: 330-275-7008  
Website: pictureitengraving.com

**ANNUAL - 3rd Saturday of January - Otto Center, Arthur, IL**

# USED BOOK AUCTION

January 15, 2022

Absentee Bids Accepted  
Request a Catalog

Catalog available by email only  
Send an email to  
abcshop@agapemail.com

Sheldon & Rhoda Reber  
Call for info: (217) 543-2655

John Miller - 217-543-2883 - Lic. # 441001855  
Sam Miller - 217-268-3465 - Lic. # 441002092

Thousands of Books  
600 to 900 lots  
Collection Harold Bell Wright,  
Horatio Alger, Jr.  
Childrens, True Stories, etc.  
Old Books & Current Books

WESTFORK

**Safeguard BOYER PRINTING & PROMOTIONAL LLC**

Your Trusted Source For:

- Custom Forms and Invoices
- Business Checks
- Envelopes and Stationery
- Business Cards
- Logo Design
- Promotional Products

Serving the Amish Community  
Since 1998  
**CALL US TODAY!!**  
We are your ONE SOURCE for everything printed. Quality, professional and courteous service.

733 School House Rd., Sunbury, PA 17801  
Call TODAY!! (570) 286-2229 / 800-268-8228  
Fax 888-603-0737 · tboyer@gosafeguard.com

## Kids Adjustable Skates

We sharpen skates

Great for school age children

LP 104B Shown

Small (11-12-13-1) Adj.	Med (1-2-3-4) Adj.	Large (5-6-7-8) Adj.	<b>New Hockey Skates Available</b> <b>GIRLS HOCKEY</b> \$55.95 a pr LP105G white/pink <b>BOYS HOCKEY</b> \$55.95 a pr LP105B black/navy
LP 104G — white/pink <b>Girls Figure \$45.95 a pr</b>	LP 104B — black/white <b>Boys Hockey \$45.95 a pr</b>		Sizes Medium 2-3-4-5-6 Large 6-7-8-9

Shin Guards, Gloves, Sticks, Lighted Pucks, Tape & More!

### Kauffman's Store

22 Meadow Ln • Loganton, PA 17747  
(570) 725-3679  
For Best Service Call 7:00 to 9:00 AM EST or leave message  
You can ask for brochure with color pictures and more items.

\*Adult sizes available

## Skid Steer Cylinders

- New Replacement
- Seal Kits
- Repair Parts
- Manufacturing

Also selling standard welded and tie rod cylinders from:

**REGISTER**

Call or write for a free cylinder and parts catalog  
**(717) 353-5784** **Call Us!!!**

Fairview Metalworks 13911 Ditto Rd Mercersburg, PA 17236

## HEAT YOUR HOME...

Proven performance, reliability and savings.

Freestanding, easy-to-operate WoodMaster furnaces work with most existing heat systems, including hot water, forced air, hydronic heat, radiant baseboard, existing water-to-water and in-floor. A WoodMaster furnace serves as a primary heat source or in conjunction with existing systems to warm homes of all sizes.

The WoodMaster 4400 heavy duty furnace is double-plumbed to heat larger homes or home-garage combinations. It offers a larger firebox, larger fuel door and higher Btu output.

Fire Box..... 38" x 44"	Total Water Capacity..... 117 gallons
Door Size..... 24" x 24"	Heating Area..... 5,000 sq. ft.
Thickness..... 1/4" Fire Drum & Water Jacket	Heating Rate... 125,000 btu/hr on a 12 hr burn
Draft Control..... Fan	Limited Warranty..... 10 years
Overall Size..... 5'2" x 5'9" x 8'1"	Shipping Weight..... 1,809 lbs.

**NASH ROAD PUMP & PLUMBING**  
16649 Nash Road, Middlefield OH 44062 • 440-548-2119

## Stauffer Brothers Flooring

1524 S. Market Street, Selinsgrove, PA 17870

**Wholesale and Retail ..... Visit Our Showroom**

CALL OR WRITE FOR FREE SAMPLES  
Jesse Stauffer, General Manager  
**570-372-1000**  
staufferbros.com  
staufferbros@gmail.com

• Carpet  
• Vinyl  
• Tile  
• Hardwood  
• Laminate

**Professional Installation Available**

We can ship anywhere

## NICE AG CRAWLERS - FOR SALE -

Better Traction, Less Compaction, Less Fuel

### Zimmerman Tractor

13874 Hwy. 5 • Versailles, MO 65084 • Closed Sundays • Hrs. 8:00 - 5:00  
573-378-7210 • We Also Sell Crawler Parts

Call for free list.  
**(717) 383-9878**  
Book searches (\$10 min.)

Amish, Mennonite, religious, history, classics, poem, children

## Thousands of good used books.

Trains, horses, tractors, 9-11, old West, biography, school, true story

### Vintage Volumes

752 Ono Road, Annville, PA 17003  
Matthew Garman, Proprietor  
vintagevolumes@emypeople.net



# AIR WORKS Ltd.

The Power Tool Connection

10680 Dover Road Apple Creek, OH 44606

# HOLIDAY SALE

Call For FREE 16 Page Christmas Catalog

(Ph) 330.698.0388 • (Fax) 330.698.3088

sales@airworksltd.com



2354-20 M18™ 1250 Lumen Search Light

Sale \$99<sup>99</sup>



DML812 18V LXT 1250 Lumen Spotlight

Sale \$99<sup>99</sup>



DCL043 20V MAX Spotlight

Sale \$69<sup>99</sup>



DML811 18V LXT 3000 Lumen Dual Power Light

Sale \$159<sup>99</sup>



2363-20 M18 18V LED Worklight

Sale \$59<sup>99</sup>



**LEATHERMAN**

830425 Wineman  
830428 Sidekick  
830547 Robber  
832532 Wave



48-11-1852 M18™ Red Lithium High Output™ XC 5.0 AH Battery Pack (2Pk)

Sale \$149<sup>99</sup>



BL1850B-2 (2 Pk) 5 AH

Sale \$149<sup>99</sup>



DCB205-2CK 2 Pk 5 AH Batteries & Charger

Sale \$159<sup>99</sup>



DCB606-2 FLEXVOLT 20V/60V MAX 5.0 AH Battery (2Pk)

Sale \$229<sup>99</sup>



DCB609-2 FLEXVOLT 20V/60V MAX 9.0 AH Battery (2Pk)

Sale \$329<sup>99</sup>

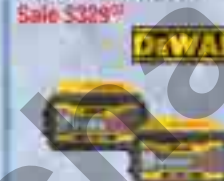

DWHT81424 200 Lumen LED Headlamp

Sale \$12<sup>99</sup>



**Millertech**

Comes with Milwaukee Lithium Rechargeable Batteries. Do not use if minimal.

K500 500 Lumen Rechargeable Headlight

Sale \$25<sup>99</sup>



557 150 Lumen Rechargeable Headlight

Sale \$19<sup>99</sup>



555-2ND 1800 Lumen Rechargeable Headlight

Sale \$49<sup>99</sup>



556-2ND 750 Lumen Rechargeable Headlight

Sale \$46<sup>99</sup>



K1200 1200 Lumen Rechargeable Headlight

Sale \$29<sup>99</sup>



DWHT71843 Soft Grip Multi-Tool

Sale \$17<sup>99</sup>



DCE5T1B 20V 17" Corded/Cordless Jobsite Fan (Bar)

Sale \$89<sup>99</sup>



DCF102Z 18 Volt, Vari-Speed Fan

Sale \$72<sup>99</sup>



CTK35 30 Pc. Socket Set

Sale \$42<sup>99</sup>



DXCS6AL 5 Gallon Water Cooler

Sale \$122<sup>99</sup>



DCHN060ABB 20V Cordless Heated Jacket S-M-L-XL

Sale \$199<sup>99</sup>



EZ-360 LIGHTS 12 WATT

3110 \$89.99 Dewalt  
4110 \$89.99 Milwaukee  
5110 \$89.99 Makita

EZ-360 Lights, compact and lightweight for use as standing or hanging lights. Flip them upside down for maximum light exposure! Lights come with a low voltage blinker shut-off. Choose your favorite battery!

Includes: AW65M bulb. Batteries not included.



**AW CORN BULBS**



Item	Watts	Lumens	Price
17/24 Volt Natural White Dustproof			
AW65C3	30 WATT	3000	\$49.00
AW65C4	12	1500	\$21.00
AW65C5	12 WATT	1500	\$26.00
AW65C6	15	2000	\$38.00
AW65C7	16 WATT	2000	\$29.00
AW65C8	20	2500	\$22.00
AW65C9	30	3000	\$40.00

204B-21 M12 Toughshell Heated Jacket M-L-XL

Sale \$209<sup>99</sup>



DC1200Z 18V Cordless Heated Jacket S-M-L-XL

Sale \$185<sup>99</sup>







## Accounting & Tax Services

**Now accepting new clients for bookkeeping and financial statement preparation**

- Extensive small business expertise in many industries.
- Located in the heart of W. PA Amish country – New Wilmington.
- Small staff – 6 people providing personalized service.
- CPA on staff.
- Budget services for all sizes – very reasonable.
- Highly experienced in start-up and troubled businesses.
- EZ to get started & EZ to work with.
- “Expertise....Affordable & Friendly”.

**Call and invite us to your business to discuss your needs**

129 S. Market Street, New Wilmington, PA | 724-301-2088

### ASK FOR A FREE ESSENTIAL OIL BOOKLET.



#### Christmas Spirit

A blend of Orange, Cinnamon Bark, and Black Spruce Essential Oils.



#### Have you ever wondered what Christmas smells like?

I think Christmas Spirit Essential Oil Blend is about as close as it gets.

The orange smells like... well orange. And having oranges at Christmas was always a tradition for us. The cinnamon makes us think of baked goodies and candy. And the Black Spruce rounds out the blend by giving it the smell of walking through a pine forest on the crunchy snow. It seems like the perfect combination.

What does it do for us? When diffused it lifts our spirits and helps fight the blues. You can smell it right out of the bottle or even apply it to your hands and smell it. The cinnamon is antibacterial, anti-fungal and antiviral which should help remove bad bugs from the air. The orange is uplifting and the spruce is grounding.

**Get a free Christmas Spirit essential oil, when you buy a premium starter kit.**



**WHOLESALE PRICES AVAILABLE EVEN FOR YOUR OWN USE!**

**Eli & Sarah Hilty**  
356 E 700 S, Berne, IN 46711

**or leave a message**  
**419.651.4518**

## Premium Starter Kit with Desert Mist



**Order Today!**

Leave Message:  
419-651-4518

Retail Value \$396

**Our Price \$165**

plus tax  
**FREE SHIPPING**

### Wholesale Member Benefits:

- Try Young Living Essential Oils for less than half of retail
- No obligation to purchase again

- 12 best-loved essential oils
- Desert Mist™ Diffuser (Or trade for Essential Oils Desk Reference)
- (2) NingXia™ Red Samples
- Thieves Waterless Hand Purifier™
- Thieves Spray
- (2) AromaGlide™ Roller Fitments

- 24% off future purchases
- Join Essentials Rewards and receive credit for free products

*How do I get started? It's easy!*

*Just complete this form and mail it to the address below.*

Yes, I would like to purchase a Premium Starter Kit and become a wholesale member with no obligation for future purchase. Please send my FREE Christmas Spirit oil too!  
Choose:  Electric Diffuser OR  Essential Oils Desk Reference

Name \_\_\_\_\_ Phone \_\_\_\_\_

Street \_\_\_\_\_

City \_\_\_\_\_ State \_\_\_\_\_ Zip \_\_\_\_\_

Payment Options to Young Living:

Credit/Debit Card # \_\_\_\_\_ Expires \_\_\_\_\_ SEC Code \_\_\_\_\_

Routing Number \_\_\_\_\_ Account \_\_\_\_\_





**SULZER**



## Pump Solutions at...



Tamaqua, PA 18252

\*Wholesale Inquiries Welcome\*

**570.668.4540**

# GRINDERS CRUSHERS SHREDDERS

**HANDLE YOUR  
WOOD SCRAP  
WITH VECOPLAN.**

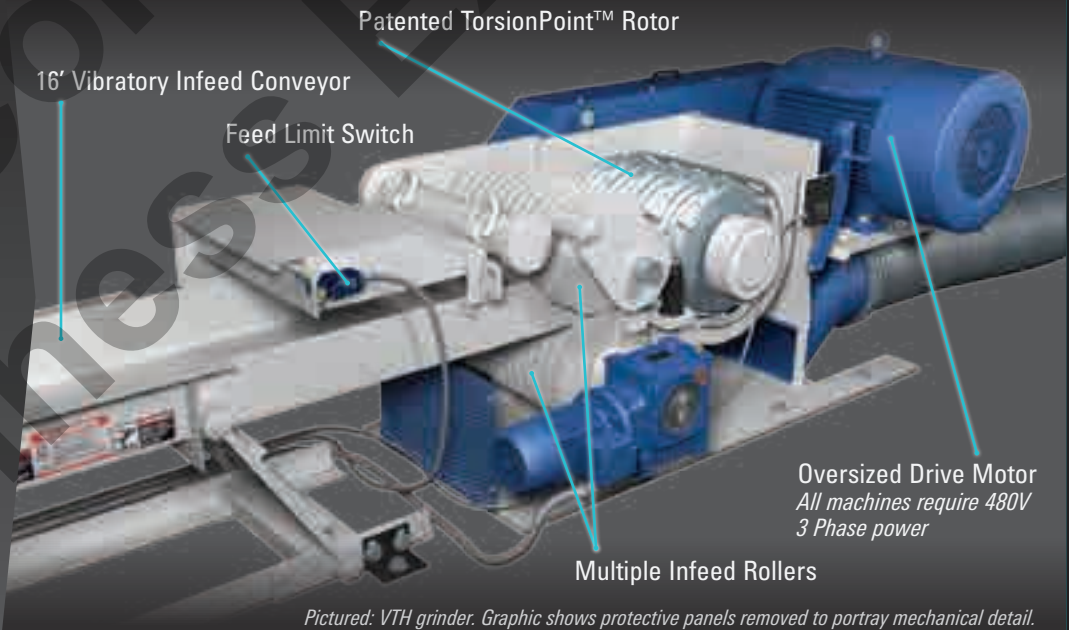

*Pictured: VTH grinder. Graphic shows protective panels removed to portray mechanical detail.*

**Stand-alone industrial-grade machines to complete wood waste processing systems**

info.us@vecoplan.com

**Vecoplan®**

5708 Uwharrie Road, Archdale, NC 27263  
(336) 252-4421 • vecoplanllc.com

4005 Earnings Way, New Albany, IN 47150  
(812) 565-8761 • vecoplanmidwest.com



Mini and small pony cart.



Heavy Duty Wire Spoke Wheel  
20", 24" and 26"



Pony size cruiser.



Lighted safety flag for pony carts.



Western Riding bridle,  
Black or Brown.



**A & A**  
Carriage • Wheel

214 North Shirk Road  
New Holland, PA 17557  
717.355.9182  
Fax 717.351.0894

CALL FOR A FREE BROCHURE

Vacuum Sealers ★ Stuffers  
Grinders ★ Biro ★ Bizerba  
Hobart ★ Vacmaster

## VP540 Vacmaster 2 20" Sealbars

VARIOUS SIZES IN STOCK

**\$2,350**

**FOOD EQUIPMENT  
SALES & SERVICE**

**MARTIN'S  
Electric**



**717-776-5500**  
100 Ridge Rd, Newville PA 17241

## Diapering made pamper FAST!

*Mom, you will love it!*

- Adjustable washable diaper cover— multiple sizes in one cover!  
0-3 month cover 6-14lb, **One Size cover 7-33lb**, XL Covers 33-50lb,  
Bedwetter Series available for 50-130lb.
- Easy to change!** Simply tuck washable bamboo insert under the  
front and back flaps to secure and snap shut. No rubber pants.  
No diaper pins.
- Double leg bands on covers** provide a double leak protection.
- Instant overnight diaper!** Place two inserts in cover for more



More prints and colors to choose from!

**dōTERRA**  
Guiding with Hope  
Ask about participating in our  
free Oil Study Program

**Happy Mom's Diapering**  
3154 Cuba Mills Rd Call today  
Mifflintown, PA 17059 717-669-5874  
happy momsdiapers@gmail.com

Request a free  
Happy Mom's  
info packet!

## NEW PROPANE LIGHTS WITH AUTOMATIC SPARK IGNITION

- These units can be installed on your existing propane lights
- Safer option than pilot lights
- Uses no gas and has no open flame when light is off
- Great for chicken houses
- On and off at your settings
- Requires 9 — 30 volt power supply



**H.C. Lanterns**  
418 Furnace Rd. | Quarryville, PA 17566  
**717-786-1049**



**Lean Back**  
Multi Fuel Stoves

High Efficiency

For greenhouses, shops, houses  
and more applications

**Hot Air & Boilers**  
50,000 - 1,000,000 BTU

Relax & let the stove  
do the work

**Backyard Produce**  
29484 Orange St., Canton MO 63435

Mfg. by Lean Machine

## SANDPAPER

Belts, Discs, Pump Sleeves,  
Rolls and more!

- Many standard sizes in stock for  
same day shipping.
- Need a size we don't stock? No problem.
- We do any size belts. One week lead time.
- No minimum size order.

1564 Main St. (Rte 23) Suite 108  
East Earl, PA 17519  
800-445-4669 Fax: 717-445-5875  
conestoga@emypeople.net



**CONESTOGA**  
WOODWORKING SUPPLY



## Clothes Drying Rings

**Great Christmas Gifts**



18" with 30 clothespins  
**\$ 81.00**  
24" with 44 clothespins  
**\$ 106.00**

Add **\$12.00** for shipping,  
Add **\$16.00** for two or more.

All Stainless Steel and Aluminum Parts.

**ORCHARD LANE CRAFTS**  
manufacturer of StainlessPro and more

8753 County Road 235  
Fredericksburg,  
Ohio 44627

## BELT DRIVEN BATTERY CHARGER

6, 8, OR 12 VOLT when regulated manually  
12 VOLT only when regulated automatically

**30 Amp Unit | Requires 3 HP**

- ▶ Charger with 4HP Honda ..... **\$495.00** plus \$55.00 Shipping
- ▶ Charger with 2.4 Brilliant Engine ... **\$419.00** plus \$55.00 Shipping
- ▶ Charger Kit less Engine ..... **\$219.00** plus \$25.00 Shipping
- ▶ Charger Only ..... **\$165.00** plus \$25.00 Shipping
- ▶ For 24/12 Volt Charger ..... Add **\$30.00** to cost
- ▶ For Lithium Version ..... Add **\$35.00** to cost

NEW DESIGN FOR LITHIUM BATTERIES

— Larger Units up to 600 Amp Available —

## WHEEL KIT OPTION FOR PORTABLE BATTERY CHARGER

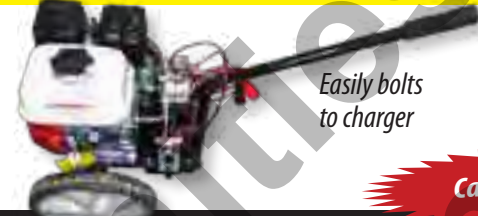

Easily bolts to charger

**\$65.00** cart only  
**Free Shipping**

Call for Dealer Pricing

**Troyer Engine** – 33720 CR 10, Fresno, OH 43824  
phone: 330-897-2805 • fax: 330-897-1040

## FASTPIPE

Modular Aluminum Compressed Air Piping

INSTALLATION AVAILABLE

Call us for a Catalog & Prices on FASTPIPE

Sizes ¾" - 1" - 1½" - 2" - 3"

- Fast installation time
- Superior air quality
- Diverse for many applications
- Energy efficiency

**Our Services**

- ▶ Hydraulic & Air Systems
- ▶ Shop Installation
- ▶ Pump, Motor & Cylinder Repair
- ▶ Fabricating, Welding & Machining
- ▶ PTO Wetlines, Mobile Equipment Repair

**BOSS** **VMAC**  
40CFM - 185CFM Hydraulic Driven, Screw Compressors

**Yoder Hydraulics**

12317 Dover Road, Apple Creek, OH 44606 | 330.857.0001

## Hundreds of Compact Tractors for Parts

phone: 717.477.9332 fax: 717-530-9705

Stocking engine rebuild kits for Shibaura, Kubota, Yanmar, Mitsubishi and Iseki Engines.

Buying salvage – anywhere, any condition

We Ship Daily

UPS, USPS, FedEx, DHL, Amazon

Open: Monday thru Friday 8:00 AM to 5:00 PM

PLEASE MENTION PCBE WHEN CALLING

**WEAVERS COMPACT TRACTOR**

**717-477-9332** 22 Fish Hatchery Road Shippensburg, PA 17257

## MANUFACTURING NEW CARRIAGES

- ▶ Specializing in carriages with outside doors
- ▶ Custom sizes available
- ▶ Over 15 years experience

**WHOLESALE & RETAIL**

DEALERS:  
Lathem Coach Works - Versailles, MO ..... 660-337-6439 Sheldon Martin - Ephrata, PA ..... 717-445-9153

**FULTON COUNTY CARRIAGE** – 7640 N 150 W | Rochester, IN 46975  
phone & fax: 574-892-5833

Also Commercial Pricing Available in Quality, Quantity, & Reliability

From: Advanced Composite Belting Drive-Flare Clutches and/or V-Belts High Motor Torque 3/8" 1/2" 3/4" 1" 1 1/2" 2" 2 1/2" 3" 3 1/2" 4" 4 1/2" 5" 5 1/2" 6" 6 1/2" 7" 7 1/2" 8" 8 1/2" 9" 9 1/2" 10" 10 1/2" 11" 11 1/2" 12" 12 1/2" 13" 13 1/2" 14" 14 1/2" 15" 15 1/2" 16" 16 1/2" 17" 17 1/2" 18" 18 1/2" 19" 19 1/2" 20" 20 1/2" 21" 21 1/2" 22" 22 1/2" 23" 23 1/2" 24" 24 1/2" 25" 25 1/2" 26" 26 1/2" 27" 27 1/2" 28" 28 1/2" 29" 29 1/2" 30" 30 1/2" 31" 31 1/2" 32" 32 1/2" 33" 33 1/2" 34" 34 1/2" 35" 35 1/2" 36" 36 1/2" 37" 37 1/2" 38" 38 1/2" 39" 39 1/2" 40" 40 1/2" 41" 41 1/2" 42" 42 1/2" 43" 43 1/2" 44" 44 1/2" 45" 45 1/2" 46" 46 1/2" 47" 47 1/2" 48" 48 1/2" 49" 49 1/2" 50" 50 1/2" 51" 51 1/2" 52" 52 1/2" 53" 53 1/2" 54" 54 1/2" 55" 55 1/2" 56" 56 1/2" 57" 57 1/2" 58" 58 1/2" 59" 59 1/2" 60" 60 1/2" 61" 61 1/2" 62" 62 1/2" 63" 63 1/2" 64" 64 1/2" 65" 65 1/2" 66" 66 1/2" 67" 67 1/2" 68" 68 1/2" 69" 69 1/2" 70" 70 1/2" 71" 71 1/2" 72" 72 1/2" 73" 73 1/2" 74" 74 1/2" 75" 75 1/2" 76" 76 1/2" 77" 77 1/2" 78" 78 1/2" 79" 79 1/2" 80" 80 1/2" 81" 81 1/2" 82" 82 1/2" 83" 83 1/2" 84" 84 1/2" 85" 85 1/2" 86" 86 1/2" 87" 87 1/2" 88" 88 1/2" 89" 89 1/2" 90" 90 1/2" 91" 91 1/2" 92" 92 1/2" 93" 93 1/2" 94" 94 1/2" 95" 95 1/2" 96" 96 1/2" 97" 97 1/2" 98" 98 1/2" 99" 99 1/2" 100"

**MARTINS**  
Troyer, PA  
570.668.4540

**BESTORQ BELTS**

# The Hand That Feeds You



JONAS MARTIN

(Part 5 of 7)

## Chapter 9 of 14

“Forty-seven-fifty bid. Now forty-eight?” Frank hesitated. This was far more than he had planned to pay for this cow. And yet, he wanted to own a cow like this so badly he could almost taste it. The auctioneer’s chant took on a pleading tone. “Don’t lose her now over fifty dollars. You’ll go to a lot of sales before you see another cow put together as perfectly as this one is. I tell you, she’d be a showpiece in anybody’s barn. I need forty-eight hundred.”

Almost against his will, Frank’s hand wavered up.

“Thank you! Forty-eight bid. And fortyeight fifty?”

The other bidder shook his head firmly.

“Forty-eight-fifty anywhere?” The auctioneer’s eyes scanned the crowd. Even the normal dozers were alert and watching to see what the top cow of the afternoon would bring.

“She’s going to a new home. Forty-eight-fifty? I sold the cow! Forty-eight hundred. Frank Sauder, the buyer. Thank you.” Frank’s hands were clammy as he wrote the price on the back of his bidder card. There was no question about it, she was a top cow, but was she really that good? There were lots of other cows here that would have put just as much milk in the tank, and for a lot less money. But those other cows all had a flaw somewhere, Frank reasoned. All but this one. As close as he could tell, she was just about perfect. And she would look wonderful in that front stall, no doubt about that.

The big question was, how would he pay for her? The sales barn would need a cheque before they let her out of the

door. Somebody else would just have to wait a little longer for his money. He should be getting another payment from the government next week on that Emergency Hog Aid Plan—that would help matters again. “Maybe the church wouldn’t be happy if they knew I’m getting those cheques,” Frank thought, “but my creditors sure seem happy to get a share!” Well, he should go settle up and arrange to have the cow trucked to his home farm, where the dairy herd was located. Frank got to his feet and started toward the office.



Two rows back, a fresh-faced teenager turned to his father, “Dad, there goes the man who bought the cow.” His father, who had been the unsuccessful bidder, spat out, “Yeah, he sure wanted her badly. Some of these people, if they want something, they just push till they get it. You’d wonder where they get the money.” The son, at that stage of life when impressions form easily, felt his own opinion of the Plain People drop just a little.

The long brassy days of summer merged slowly into the crisper golden days of fall, as all summers will. Frank noticed the rising moon as he walked slowly toward



## Chapter 9 and 10

the house one evening. “The moon’s just about full,” he thought. “Is that what they call a harvest moon? We just might get a touch of frost by morning.” His son Jason, who had gone in half an hour earlier, was waiting for him in the kitchen. He was turning an official-looking envelope over and over in his hands. The farm paper lay open on the table in front of him, but Jason’s attention was obviously not on it.

When Frank came over, Jason handed him the envelope, saying simply, “You’d better read this, Dad,” before lapsing into tight silence. Frank shook out the single sheet of paper inside. The letterhead read:

*Canadian Forces, Base Borden  
Department of National Defence*

The message the letter contained was short, but that didn’t soften its impact at all.

*Dear Mr. Jason Sauder,*

*As you may be aware, Bill 159, the Emergency Measures Mobilization Act, has recently become law. The Act calls for the selection and drafting of young men from age 18 to 22 from across Canada to serve a two-year term with the Canadian Armed Forces. Your name is among those that have been randomly selected.*

*You are required to report to the main office at Canadian Forces, Base Borden within 14 days of receiving this notice. You will be examined by our doctors to ensure you are in good health and will complete a skills test to enable us to decide how you can best serve your country. You will then be informed where and when you are to*

### EDITOR’S NOTE

This is a portion of a continued series being published each month in PCBE.

*The Hand That Feeds You* is a fictitious book published in 2009 by Vineyard Publications. The scene and happenings are not actual events, but rather a story using a Canadian setting, of what the author envisioned could happen if the Anabaptist communities take part in government handouts. This book will be reprinted in its entirety from August 2021 thru February 2022. To purchase a copy of this book, refer to the ad at the conclusion of this article.

*report to begin your term of service.*

*If you feel there is a valid reason why you cannot meet these requirements, you have the option to immediately appeal to the Draft Appeals Tribunal.*

*Sincerely, Arnold Powers*

*Chief Recruiting Officer*

*The Hand That Feeds You - Continued on Page 210*

# The Hand That Feeds You

*The Hand That Feeds You - Continued from Page 209*

Frank turned the sheet over. The back side held nothing but directions to Base Borden and several addresses, including the one for the Appeals Tribunal.

Jason was watching him, waiting for his direction. “I’ll take this over to Elmer tomorrow,” he decided. “Surely the deacons have some type of exemption forms for this.”

The next morning Frank was at Elmer’s door. He mentioned something about exemption forms as he handed the letter to Elmer to read. Reality began to set in as Elmer slowly shook his head. “We asked for an exemption from this but were not granted it. As far as I know the best we can do is to write to the Appeals Tribunal and plead our case. Luke Frey also got a notice like this a few days ago. The committee and some of our ministers are planning to meet at Bishop Ezra’s on Thursday afternoon to discuss our response. “I’d encourage you and Jason to come as well.”

Jason was rather absentmindedly finishing up the morning chores when Frank got home. He seemed to brighten up a little when his father told him what he had found out. No doubt the knowledge that his good friend Luke was in the same shoes gave him some comfort. The thought occurred to Frank that Jason would probably feel more at ease with the group at Ezra’s than he himself would. People like Aaron Frey were okay, he supposed. He really had nothing against Aaron, but neither did his way of thinking hold much common ground with his own.

Luke Frey had never felt more like a little boy than he did now, as he followed his father up the walk to their bishop’s house. Ezra opened the door to welcome them in, his ever-present cane in one hand. “When you turn your attention to Ezra’s face rather than his limp and his cane, he seems like a much younger man,” Luke decided. His eyes were active and intelligent, his smile of greeting sincere.

Luke trailed behind as they were shown into the living room where the men were gathering.

He gratefully took the empty chair beside Jason Sauder. His eyes met Jason’s. Just having a friend in the same straits with you made the situation a little less scary. Luke looked

around the room. Next to Jason sat his father. Over at the end Bishop Ezra had taken his place with the rest of their home ministry. Along the opposite wall was the committee Dad was on. Luke recognized two or three men, but mostly they were strangers to him. However, he could see by the way his father greeted them that he had developed a feeling of comradeship with this varied group.

The hum of casual conversation ceased as Ezra cleared his throat. “I believe everybody is here who is coming. I’m glad you were all able to come on such short notice. Before we begin, I think a moment of prayer would be appropriate, asking for God’s leading for what lies before us.” Ezra led in prayer, then turned to Luke’s father, “Would you read the notice Luke got, just so we’re all clear on what we’re confronting?”

Afterward Luke could never remember much of the discussions that afternoon. What he did remember was his overwhelming feeling of being like a helpless little boy. All these men were putting in their time and effort on his and Jason’s behalf. Eventually the discussion had focused on drafting a letter to the Appeals Tribunal. By the time they parted, there was full agreement that the letter was ready to be put in the mail the next morning.

## Chapter 10 of 14

Bruce had to restrain himself from breaking into a trot as he strode down the corridor toward the office. He dodged through a group of tourists and took the steps two at a time rather than wait for an elevator. His assistant looked up as he sailed into the office. “Where’s the fire?” he asked with a grin. Bruce muttered something about twenty-minute meetings that dragged on for an hour and a half, then turned his attention to the reports on his desk. Here was another stack from the Draft Appeals Tribunal for him to check through. He had to admit the Tribunal was doing good work. The reports they sent with each application were thorough and professional. In most cases Bruce simply signed his approval to the decision they had reached, either granting or denying the appeal.

He quickly read several, signing his name to one as he picked up the next. The fifth one caught his attention. It was a joint



appeal from two young men whose names sounded vaguely familiar. A glance at the signatures on the letter confirmed his suspicions. It certainly was a small world. The boys' fathers had signed as well. One was Aaron Frey, who had hosted the meeting he and Tracy attended. The other was Frank Sauder. Wasn't he the man who had taken over Rick and Kathy's farm? He began reading the letter:

*Draft Appeals Tribunal*

*Dear Sirs:*

*We are writing to you in response to the draft notices received by two young men of our faith. The way we understand the teachings of the New Testament, it is wrong for us to bear arms. We have included a copy of the letter sent several months ago to Defense Minister Rayburn which explains our beliefs in more detail.*

*We are very grateful for the leniency past governments have granted to our people, and plead that the government of today may do the same. We are willing to do work for the good of the country in a non-military way if some type of alternative service program could be set up. We trust our past record will show that we have tried to be a help rather than a burden to our country.*

*Our plea is that you would grant us exemption so we can continue to live according to the dictates of our faith and conscience.*

*Respectfully yours, Signed \_*

The signatures included those of both young men, their fathers, a bishop of their church, and several members of the committee Bruce had met at the Frey home. The Tribunal's report stated that both men were indeed members of the church and that neither had a criminal record. Sauder was working on the family farm and Frey lived on his parents' farm but worked part-time on a construction crew. The Tribunal had recommended granting both appeals.

Bruce pushed the papers aside. This would require a little more thought. He continued with the other reports on the stack. Agriculture Minister Tony Wheeler looked up as Bruce knocked on his office door early the next day. "Good morning, Bruce! Nice to see somebody else is up and around

before the day's half done. What can we do for you?"

Bruce hesitated. He wasn't sure how much he should tell Tony. He wasn't even sure how much he still liked the brainstorm that had seized him at two o'clock in the morning after several sleepless hours. But... he was here now, and he might as well follow through. The worst Tony could do was turn down his request.

Tony listened intently as Bruce told him about the first letter from the Plain People asking for exemption from military service. Then of the meeting he and Tracy had attended, and now yesterday's appeal to the Tribunal. "Each time they make reference to this point of looking after their own people," Bruce explained. "I can follow what they are saying—if they don't accept help from us, it seems more reasonable that they don't owe us any help in return. My worry is, are their hands really clean? Are they actually doing what they say they are? I feel I owe it to myself and to them to check that out before I sign these exemptions." Bruce paused, then plunged on, "Your department looks after farm subsidies. I have a hunch you'd be able to tell me whether a certain person is getting any, or not."

*The Hand That Feeds You - Continued on Page 212*



# The Hand That Feeds You

*The Hand That Feeds You - Continued from Page 211*

Tony looked him in the eye. “Yes, I’d be able to get that information. I’m sure you realize though that privacy rules won’t allow me to give it to anyone, not even within my own department. However, I guess I couldn’t help it if I happened to be looking up something on the computer and you just chanced to look over my shoulder at an opportune moment.”

Tony pulled his keyboard toward him and the screen on his desk silently flickered to life. He began typing swiftly and after a few moments, glanced at the scrap of paper Bruce had wordlessly laid at his elbow. His fingers danced again, and Bruce watched as the first name on his little list appeared on the screen. EZRA MARTIN. There was a pause, then the brief message, NOT FOUND IN SYSTEM.

The name LUKE FREY brought the same response. Next came AARON FREY. This time the computer had a little more information.

OWNER: SWINE FARM, MILLER VALLEY, ONTARIO

NO PREVIOUS PAYOUTS TO THIS ACCOUNT NO CURRENT APPLICATIONS

Bruce began to breathe easier. This was what he had hoped to prove to himself. Tony was typing the next name. Just two more to go, Bruce thought, as he waited for the computer to sort through its memory.

FRANK SAUDER – PARTNER WITH JASON SAUDER

OWNERS: SWINE FARM, MILLER VALLEY, ONTARIO

CURRENTLY ENROLLED IN HOG EMERGENCY AID PROGRAM

SEE NEXT SCREEN FOR LIST OF PAYOUTS TO THIS ACCOUNT

Bruce felt as though something had hit him in the stomach. He stared at the numbers Tony had pulled up. Almost he wished he had never asked. Of all the nerve! Why did they do it? This sweet talk about “looking after their own” and yet obviously at least some of them were also drinking out of the public trough.

Tony, watching the clouds roll over Bruce’s face, spoke up, “What’s the matter? They’re citizens of this country the same as you and I. Why shouldn’t they take public money if it’s available and they qualify for it?”

“That’s just it! They say they’re citizens of a heavenly kingdom. They say they have a brotherhood who help each other, and they don’t want our help, nor need it. But now I see this ...” Bruce lapsed into silence. “Anyway, thanks so much for your cooperation. I’m going back to my office. I’ve got some heavy thinking to do.”

**Continued next month...**

*This article was originally published as a book by Vineyard Publication, Wallenstein, Ontario and has been reprinted with permission. All characters are fictitious and any resemblance to actual people or situations is unintentional. To order a copy of the book, please refer to the advertisement below.*



**BACK COUNTRY OPTICS**

New Color Catalog With Bargain Cave

We give volume discounts  
Free Shipping!  
MO Residents add 6.35% Sales Tax

Joshua Bontrager  
660- 486-3202  
13006 Beechnut St, Ethel, MO 63539

Mention code PCB5 for 5% off

Logos: ZEISS, blockhound, LEUPOLD, ATN, GPO, SWAROVSKI OPTIK

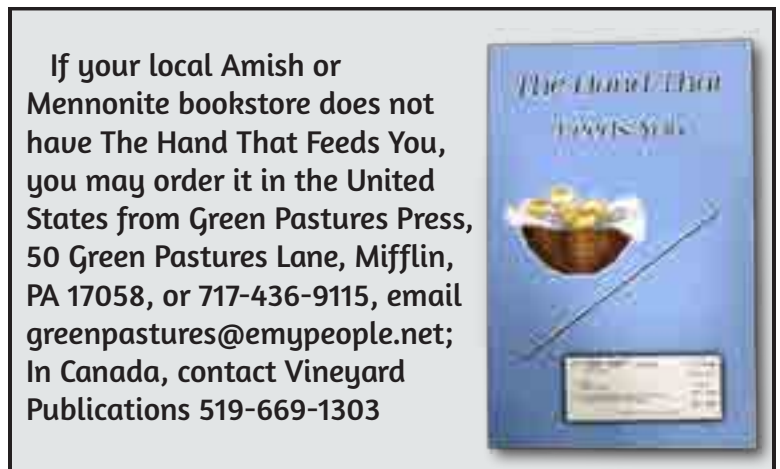

If your local Amish or Mennonite bookstore does not have *The Hand That Feeds You*, you may order it in the United States from Green Pastures Press, 50 Green Pastures Lane, Mifflin, PA 17058, or 717-436-9115, email [greenpastures@emypeople.net](mailto:greenpastures@emypeople.net); In Canada, contact Vineyard Publications 519-669-1303





# From Mother Nature

to High Quality Wood Coatings



Timberlane is honored to be a full stocking distributor of Renner Wood Coatings.

Renner provides some of the best European wood coatings in the industry with the United States HQ located in Charlotte, NC for convenient and quick shipping and with our fully stocked warehouse and color matching capabilities at our facility in Ohio.

Renner Wood Coatings provide the most advanced technology in both water and solvent based finishes selling products in more than 85 countries.

Choose Renner and Timberlane Finish Solutions for the ultimate in the latest Italian Coatings Technology.

Here are just some of the products and services we offer.

**FULL SERVICE COLOR MATCHING CAPABILITIES**

**SOLVENT & WATER BASED WIPING STAINS**

**SOLVENT AND WATER BASED SPRAY STAINS**

**24 HOUR POT LIFE ACRYLIC URETHANES**

**2K WATERBASED ACRYLIC URETHANES**

**PREMIUM HIGH BUILD CONVERSION VARNISHES**

**HIGH BUILD PRECATALYZED COATINGS**

**EXTERIOR HYDRO OILS**



**TIMBERLANE**  
FINISH SOLUTIONS

🌐 [www.tlfinish.com](http://www.tlfinish.com)

✉ [customerservice@tlfinish.com](mailto:customerservice@tlfinish.com)

☎ 419-465-8255

# MAGNETS

TO HOLD DOORS OPEN AND SHUT

THIS MAGNET WILL HOLD YOUR SCREW IN PLACE FOR EASY INSTALLATION







MH-84 1" Magnet  
Fits screw drivers

*Beechy*  
BUGGY SHOP

1475 S. 250 W., LaGrange, IN 46761  
260-499-3277 ext. 4

## Magnet Disc

-  M-80 1" Magnet
-  M-81 3/4" Magnet
-  M-82 1/2" Magnet
-  MB-82 1/2" x 1/2" Magnet Magnet Barrel
-  M-83 3/8" Magnet

## Steel Cups

-  MC-80 Cup  
To use with M-80 1" Magnet
-  MC-81 Cup  
To use with M-81 3/4" Magnet
-  MC-82 Cup  
To use with M-82 1/2" Magnet
-  MC-83 Cup  
To use with M-83 3/8" Magnet, Not Magnetic

Steel cups increase a magnet's attraction (usually by a factor of 4). Inserted into a screw-mounted cup, there is little chance a magnet will pop out.

- Uses:
- RV Parts
  - Rattle Free Front Latch
  - Cabinet Doors
  - Carriage Doors
  - Power Unit Shields

## Magnetic Strike Plates

-  MH-84 1" Magnet  
Fits screw drivers
-  MH-80 1" Magnet  
With countersunk hole
-  MH-81 3/4" Magnet  
With countersunk hole
-  MH-82 1/2" Magnet  
With countersunk hole
-  MH-83 3/8" Magnet  
With countersunk hole

## Steel Strike Plates

-  MSP-80 1" Steel Strike Plate
-  MSP-81 3/4" Steel Strike Plate
-  MSP-82 1/2" Steel Strike Plate
-  MSP-83 3/8" Steel Strike Plate

## Forstner Bits



Available Sizes:  
3/8", 1/2", 5/8", 3/4", 7/8", 1", 1 1/8"

## Stainless Steel Windshield Wiper



Wholesale pricing available.

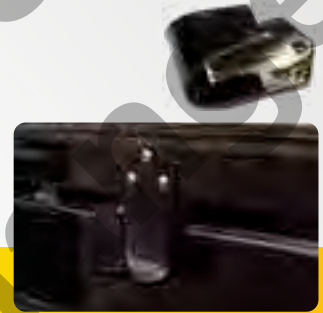

## WANT A FRONT LATCH THAT DOES NOT RATTLE?

**TRY MAGNETS**

Multiple uses, your imagination is the limit.

**Super Strong**

1" = 47lb.  
Test Lift

# MATTRESS SETS

MANUFACTURING  
QUALITY TWO-SIDED BEDDING  
for over 35 years

Pillow Top Plush



Deluxe

CONTACT US FOR A  
DEALER NEAR YOU.

With over 20 different models to choose from,  
we have something to fill your needs.  
From the basic to the Master Suite

WE HAVE A LARGE INVENTORY FOR QUICK SHIPMENT | MOST SIZES AND STYLES IN STOCK  
SPECIAL PRICING FOR MOTEL, LODGES AND STUDENT HOUSING

Quality Bedding at Affordable Prices

Accepting new dealers  
in select areas

Your Source For Quality Mattress Sets

Comfort Core Collection  
(offered in Three Comfort Levels)



Individually wrapped pocketed coil offers  
more flex and comfort built into the unit.



**COUNTRY BEDDING MFG., LLC**  
2696 S. Carr Road • Apple Creek, OH 44606

Hours: Monday, Tuesday & Friday 8-5 | Wednesday 8-7  
Saturday 8-3 | Closed Thursday & Sunday



# PERMANENT POST-FRAME SOLUTIONS



Perma - Column Precast Concrete Columns



Sturdi - Wall® Drill Set



Sturdi - Wall® Wet Set

## BUILD YOUR BUSINESS WITH PERMA - COLUMN®

Grow with the leader in permanent post-frame solutions. All Perma - Column® and Sturdi - Wall® products are ICC-approved, engineered to accelerate and enhance your building methods, and built to elevate your reputation for enduring quality.

MID-SOUTH PERMA COLUMN  
**731-414-0343**  
1226 N MAIN STREET DYER TN 38330

**BUILD BETTER.  
BUILD STRONGER.  
BUILD TO LAST.**



WWW.PERMACOLUMN.COM

**WE SHIP NATIONWIDE**

## ZIMMERMAN SKID LOADER

## Other Machines Available

**2011 Bobcat T650**  
2600 Hrs, Orops, Pilot Controls, Kubota Diesel, 2570 lb lift, 70% Tracks, New Bucket  
**\$28,500**



**2011 Bobcat S175**  
2800 Hrs, Cab, Heat SJC, New tires & Bucket  
**\$19,500**



**2012 Kubota SVL 75-2**  
C/H/A, 2 Spd, 3000 Hrs, 2300 lb Lift, Pilot Controls, 50% Tracks  
**\$35,500**



**2016 Bobcat T590**  
3700 Hrs, Orops, Pilot Controls, 80% Tracks, 2100 lb lift  
**\$27,500**



**2011 Kubota SVL 75-2**  
2900 Hrs, Pilot Controls, 2 Spd, New Tracks, 2300 lb Lift  
**\$31,500**



**2015 Bobcat S 650**  
2700 Hrs, Foot Controls, Orops 60% Tires, 2690 lb rating  
**\$26,800**



**2013 Bobcat S650**  
2700 Hrs, Foot Controls Orops, 40% Tires, 2690 lb rating  
**\$24,500**



**2003 Bobcat S160**  
4000 Hrs, Open Cab, 1600 lb. lift, Hand & Foot Controls, 50% Tires,  
**\$12,000**



**John Deere 450B**  
6 way Manual Blade, Needs Tracks  
**\$4,500**



**2005 Bobcat S300**  
Shows 1500 Hrs, Orops, New bucket, 50% Tires, Hand & Foot, 3000 lb Lift  
**\$19,500**



**2017 Bobcat S570**  
2400 Hrs, CAB, Air Pilot Controls, Power Tach, 40% Tires, 1950 lb rating  
**\$27,500**



**2013 Case TR270**  
Cab Heat, 1800 Hrs, C/H, 2 Spd, Power Attach, 50% Tracks  
**\$32,500**



**2017 CAT 2590**  
C/H/A, 2 Spd, 3400 Hrs, Pilot Controls, 2030 lb Lift, New Tracks  
**\$37,500**



**2007 Bobcat T190**  
3300 Hrs, Orops, Hand & Foot, 1900 lb lift, 50% Tracks, New Bucket  
**\$22,500**



**2011 New Holand L185**  
Erop Heat, 4400 Hrs, 2 Spd, New Bucket, 50% Tires, Pilot Controls, 2600 lb Lift  
**\$18,500**

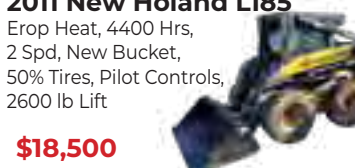

**2006 John Deere**  
C+ 322, 3300 Hrs, Open Cab, Case Hand Controls, 80% Tracks, 2200 lb Lift  
**\$18,000**



4681 Cove Mountain Road | Roaring Spring, PA 16673 | **814.224.5483**

# DIAMOND BAR GATES



# ASH

Supplies, LLC



**Dealer Inquiries Welcome**

234981 CTY. RD. H, EDGAR, WI 54426  
715-352-3599

103656

## Custom Prefinishing



*Save Time & Money  
Let Us Prefinish  
Your Tongue & Groove,  
Siding, Trim, & Flooring*

- Interior/Exterior
- Sales T&G, shiplap, log siding & paneling
- Custom end matching available with volume specific pricing

**CENTERVILLE  
WOOD PRODUCTS**  
*Custom Prefinishing*



50 Beetem Hollow Road • Newville, PA 17241

**717-486-0099**  
James Zimmerman

**Wholesale  
& Retail**

## BUGGY SPEEDOMETERS

### Cateye Velo 7



- Current Speed
- Average Speed
- Maximum Speed
- Trip Distance
- Trip Time
- Total Distance
- Speed Comparison
- Clock
- Includes all mounting hardware

**\$65.00**  
Free  
Shipping

Instructions included • One year warranty • Free shipping  
Heavy duty 12' wire with disconnect

### Bryton Rider 15 No Wires, Quick install Uses GPS



- Current Speed
- Average Speed
- Maximum Speed
- Trip Distance
- Trip Time
- Clock
- Altitude
- Total Distance
- Total Ride Time
- Speed Comparison
- Clock
- Back light
- Current Temperature
- USB Rechargeable, 16hr of use

**\$85.00**  
Free  
Shipping

**Purchase extra mounts, and quickly  
switch from buggies, tractors or bicycles.  
Bicycle mount included**

**Martin's Bicycle**  
4762 St. Rt. 14A  
Dundee, NY 14837  
Phone 607-243-7150  
Fax 607-243-9655

**Free 2021 Bicycle Parts Catalog**

- Repair tools • Repair book • Wheels • Saddles • Lights • Fenders •
- Cables • Chains • Sprockets • Tires • Tubes • Shifters •



**Share the Love of Jesus This Christmas**  
*Your gift of \$20 is all it takes for a poor child in India to  
receive a special gift!*

This year, more than ever, the children in India need you. You can bless a child who might otherwise get nothing this year. Your gift can show the love of Jesus to some of the world's poorest children.

**Heart of Hope India**

1586 County Rd 53, Killbuck OH 44637  
330-852-6067 | hohindia2020@gmail.com

*You can give online at [www.heartofhopeindia.org](http://www.heartofhopeindia.org)*



## Daily Discounted Bus Service



Service to and from the following locations:

- Indiana: Angola, Elletts, Decatur, Spencer, Upperville, Marion, Middlebury, Napoleon, Silver Plains, Shepherdsville
- Ohio: Cambridge, Franklin, Mt. Sterling, Newcomerstown, Piquette, Sardinia, West Salem, Wooster

Service to over 20 regional destinations including: CLEVELAND, COLUMBUS, CINCINNATI, BUFFALO, CHICAGO, CHARLOTTE, LOUISVILLE, FORT WAYNE & INDIANAPOLIS  
WITH CONNECTIONS TO GREYHOUND & AIRTRAK

Barons Bus is locally owned and operated by the finest drivers. All buses are licensed and giving you comfort and peace of mind while traveling.

Call Toll Free 1-888-378-3823 for more information or tickets  
Monday-Friday 9am-5pm

# BUSINESS OPPORTUNITY FOR SALE MOULDING FACILITY IN MIDDLEFIELD, OHIO.

## SET UP WITH LINE SHAFT AND HYDRAULIC, KILN ON SITE.

**CALL: 440-313-8960 FOR MORE INFO.**

**SERIOUS INQUIRIES ONLY**



**NEW!** Photo with every recipe  
Full Color · 170+ pages

# LOVE AT FIRST BITE

**\$19.99** Call for wholesale pricing!

**KAREN MAST**  
2149 Clymer Sherman Rd · Clymer, NY 14724  
Ph: 716-355-4639

## Creating Energy Efficiency



With energy costs consistently rising, Everlast Roofing is proud to offer energy efficient products. Our energy star rated metal roofing and siding is available in a variety of colors in our Fluorpon® paint system. When energy costs get high Everlast has you covered.

**Everlast Roofing, Inc.**  
OUR NAME SAYS IT ALL

**Everlast Roofing, Inc. • Call toll-free 1-888-339-0059**  
Serving USA Mid-Atlantic, New England, Central and Midwest Regions



*Love using your diffuser?  
Tired of the same old combinations?*

NEW Daily Diffusing perpetual calendar has 366 essential oil recipes.

To receive your copy send \$15 plus \$5 shipping per book to:

**Mary Ellen Miller**  
1474 Moore Road, Orwell, OH 44076

Wholesale Inquiries Only  
**Call: 440.632.0105**

## 2021 WORLD BOOK Encyclopedia

\$999<sup>00</sup> • FREE Shipping



2020 available at \$399<sup>00</sup>  
Contact Mattie Lowry at 301-739-8542 to order.

# Sawmill Exchange

**NORTH AMERICA'S LARGEST SOURCE OF USED PORTABLE SAWMILLS**

- Portable Sawmills
- Commercial Sawmills
- Pallet and Cutstock Manufacturing
- Firewood Manufacturing
- Chipping and Grinding
- Trimmers
- Debarkers
- Dry Kilns
- Edgers
- Resaws
- Ripsaws and Gang Saws
- Loaders
- Moulders and Planers
- Sawdust Blowers and Chains
- Conveyors/Transfers/Decks/Green Chain
- Rolling Stock and MUCH MUCH MORE!!!

Call us to Sell Your Equipment Call us for a list of over 800 ads

**800-459-2148** (US and Canada)  
8544 West Bellfort PMB #328, Houston, TX 77071

**STRAIGHT TALK AND SAWMILLS**  
That's what you get at **SAWMILL EXCHANGE**

# John Deere

- 4045T Power Tech
- Rebuilt
- 105 hp 1800 rpm

**Nathan Troyer**  
**231-821 2603**

7960 Roosevelt Rd.  
Holton, MI 49425



# Ben Jones Machinery

Div. of Dickert Enterprises, Inc.

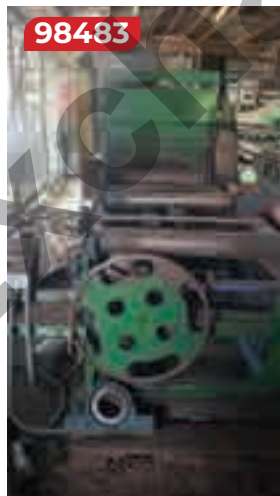
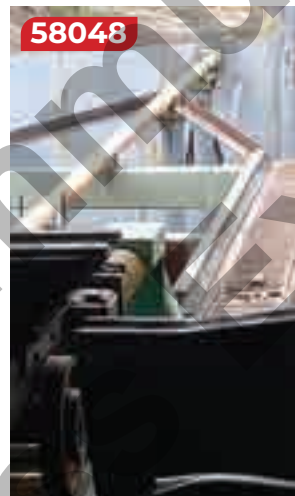
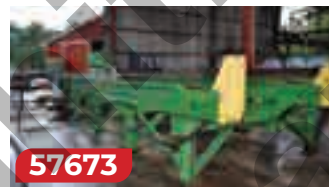

## Are you in the market for sawmill equipment?

We have a huge selection to choose from. We have sawmills, gensets, chip packs, conveyors and nearly anything else you could want. If we don't have it, we can help you find it.

We can convert some pieces to direct drive, hydraulic, electric or air.

**Give me a call and we will do our best to meet your needs.**

**WES Graber  
Sales**

**260-239-8686**  
[wgrab@benjones.com](mailto:wgrab@benjones.com)





### Business Solutions for Debit, Credit, & EBT Processing



- Rates as low as 1.29%
- 100% interchange pass-through
- No sales volume minimum to qualify for wholesale rates!
- NEW OPTION—High speed processing without internet access
- No long term agreement; We'll put that in writing!
- In office PCI Compliance with No PCI Compliance fee
- Honest analysis and understanding of current rates
- Guaranteed long term pricing

Your loyal customers keep you in business. Don't upset them with overpriced "Credit Surcharges" or "Cash Discount Programs." Call Curvin today to evaluate your payment processing options.

## Merchant Services with Integrity

13+ Years of Experience Serving the Anabaptist Communities



Curvin Martin family



1-866-672-0190

Fax 570-300-2208

Portion of net profits supports CAM

An independent sales office



# Click, Lift, Move. It's That Easy!

**Simplify moving trailers  
by forklift with our  
revolutionary Trailer Mover.**

### Features

- Self-locks onto forklift tines
- Four-way receiver: 1-7/8", 2", and 2-5/16" ball hitch and pin hitch
- US Patent Pending

### Designed to Move

- Gooseneck Trailers
- Bumper Hitch Trailers
- Clevis Pin Hitch Wagons
- Option available for Fifth Wheel Trailers

**Connect With Us Today**

**P: 217-543-5214**

**F: 217-543-4157**





# A-M GUTTER GUARD™

The Difference is in the DESIGN

**EASY TO INSTALL IN NEW OR EXISTING GUTTERS**

- Designed specifically for hidden hangers but works with all hangers
- Heavy gauge .018 - 100% aluminum will never rust
- Invisible from the ground
- Handles downpours
- Pest and weather (snow/ice) resistant
- Easy to install on new or existing gutters
- Does not make contact with shingles (will not void shingle warranty)
- Eliminates gutter clogging

**How Do A-M GUTTER GUARDS Work?**  
Our unique bubbled filtration system allows rainwater to pass through our patent pending design while leaving debris to dry and blow away. Our maintenance-free design not only keeps debris from sticking; it promotes airflow from top and bottom allowing debris to dry and blow away in winds as low as 5 mph.

**LIFETIME WARRANTY**

CALL TODAY TO HAVE IT SHIPPED TO YOUR DOOR... ANYWHERE IN USA!

talk to us about dealer opportunities  
We have **GREAT Wholesale Pricing**

**A-M SEAMLESS GUTTERS™**  
WHERE QUALITY COMES FIRST

**13970 Old State RD  
Middlefield OH 44062  
440-321-5336**

# Grow Lights

Help your Plants grow in the winter!!

For Home or Commercial use!

**18W Bulb...\$49.50**

**Call for more information!**

"For Butter Crunch Lettuce...less powdery mildew, heavier heads, better roots... better overall quality! Leaves twice as thick; roots twice as much within the first few weeks. 20% more weight; 20% faster growth! A 7-week crop is now 5 weeks!"

"When the lights were taken away, the quality decreased."  
Improved "overall health & thickness of the plants."  
"After 5 nights of using this light, I increased up to 75% on Swiss Chard."  
"Older growth had a lot less diseased spots."

**Cardinal Halls Repair LLC**  
370 Cardinal Drive  
Quarryville, PA 17566  
**(717) 786-3801**

# Millcreek Machine

*Designing and building of custom machines*

## Shavings Bagger

Up to 60 bales per hour!

*We can custom build to your specification!*

**Power Requirements**

- Hydraulic
- 110 V Electric

**Features**

- Automatic and manual controls
- Rotating beater in hopper
- Adjustable bale length

**Bagger Capacity**

- 12"x11"x36" 3.0 cubic foot

For more information or a Brochure Call...  
1560 Township Road 151  
Baltic Ohio 43804  
PH: 330-897-0735 FAX: 330-897-1169

# Millertech LED Lighting

**Model 555 Double Power (2nd Gen) Rechargeable LED Millertech Headlamp**

**2ND Generation**

- Military-Grade Aluminum
- Sleek / Slim / Lightweight
- Smooth Dimming (5-100%)
- (Smart) Mode Memory
- Built-In Fuel Gauge
- 1800 Lumens
- Max Runtime: High=2.5 Hrs, Low=100 Hrs
- High Capacity Millertech Li-ion Battery

**DOUBLE POWER 1800 Lumens**

**5 YEAR WARRANTY**

**Best Seller!**

Item# 555-2nd Retail Price = \$55.95

---

**Model 556 High Power (2nd Gen) Rechargeable LED Millertech Headlamp**

**2ND Generation**

- Military-Grade Aluminum
- Sleek / Slim / Lightweight
- Smooth Dimming (5-100%)
- (Smart) Mode Memory
- Built-In Fuel Gauge
- 750 Lumens
- Max Runtime: High = 5 Hrs, Low = 120 Hrs
- High Capacity Millertech Li-ion Battery

**HIGH POWER 750 Lumens**

**5 YEAR WARRANTY**

Item# 556-2nd Retail Price = \$49.99

**\$5.00 shipping on any quantity**

**Heartland Enterprises LLC**  
30584 CR 150, Nappanee, IN 46550  
Phone: **574-354-2938** • Fax: **574-354-7400**  
**We Ship Nationwide**



4555 Highway 433  
Mackville, KY 40040

Phone: (859) 375-5015  
Fax: (859) 375-0001

rosewood coffee  
roasters

fresh coffee. pure & simple

WE HAVE **Fresh Roasted Organic Coffee**

give...

the gift of coffee this holiday season!

Do you have a coffee-loving friend? Wanting an amazing gift bag for your employees? Is there someone in your life who seems to have everything? Look no farther.

Choose any combination of products from the catalog to create your own unique gift bag.

Request a free catalog to see the complete list of our truly nice coffees.



Presses, Grinders,  
Pour Overs,  
Commercial Brewers  
And More...

Request a **FREE COFFEE & BREWING EQUIPMENT CATALOG**

**WE OFFER AUTOSHIP!**

Place an order for the coffee you like and we'll send you your standard order every month.

**CANTILEVER RACKING**



The Cantilever Rack system is designed to manage loads of varying length and proportion without any interference. Product can be completely accessible from the front without any of the horizontal restrictions of traditional pallet rack. The entire length of the cantilever rack may be used for storage. For added flexibility, loads of differing lengths may be stored on the same cantilever rack and even at the same level.

**PALLET RACKING**



We manufacture roll-formed Pallet Rack and structural rack to fit any warehouse storage requirement. Selective Pallet Racks are the main component of every warehouse storage system.

**SEND US YOUR SIZES AND WE'LL SEND YOU A QUOTE**

**SCISSOR LIFTS, STACKER LIFTS, PALLET JACKS, LUMBER CARTS, PALLET RACK, CANTILEVER RACKS, ALUMINUM DOCK PLATES AND CASTERS**

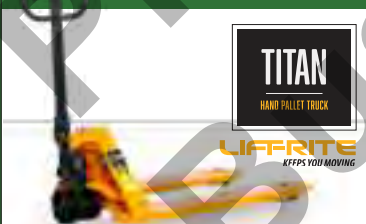

**TITAN**  
HAND PALLET TRUCK  
**LIFARITE**  
KEEPS YOU MOVING

**Standard Specifications**

- Capacity: 5,500 lbs.
- Low Height: 3.00 inches
- Raised Height: 7.75 inches
- Wheel Diameter: 7.00 inches
- Wheel Type: Nylon
- Roller Diameter: 3.00 inches
- Roller Type: Nylon



**Standard Specifications**

- 1,000 or 1,500 pound capacity
- Lift heights of 24" or 41"
- Standard hand-control pendant
- Easy-to-service internal power unit
- 1/2" steel plate scissor legs
- Powered up, powered down units
- Internal 1/3 HP 115/1/60 power unit
- Hinged platform allows for easy access to cylinders

**Troyer Wholesale**  
2890 S. Kansas Road • Apple Creek, OH 44606  
phone: 330-698-1778



70793 CR 11 Nappanee IN, 46550

**T.M. Teck Machine**  
YOUR LOCAL FABRICATION SOURCE!

**GET US TO BURN YOUR PARTS**

Cutting | Bending | Welding

You can get a semi load of seconds steel plates

Call  
**574-773-7004**

**SEBO**  
MADE IN GERMANY

**GERMAN ENGINEERED**

Powerful, Commercial Grade Motor, Easily Maneuvered!  
10 Year Warranty!

**FREE SHIPPING**  
We know what we sell!

<p><b>SEBO Air Bell K2 Vacuum</b></p> <p>Handheld and upright. The standard for cleaning with vacuum. All-in-one cleaning. 4.5 gallon capacity. 1000 watt motor. 120V. 110V. 220V. 240V. 277V. 380V. 480V. 600V. 690V. 720V. 800V. 900V. 1000V. 1100V. 1200V. 1300V. 1400V. 1500V. 1600V. 1700V. 1800V. 1900V. 2000V. 2100V. 2200V. 2300V. 2400V. 2500V. 2600V. 2700V. 2800V. 2900V. 3000V. 3100V. 3200V. 3300V. 3400V. 3500V. 3600V. 3700V. 3800V. 3900V. 4000V. 4100V. 4200V. 4300V. 4400V. 4500V. 4600V. 4700V. 4800V. 4900V. 5000V. 5100V. 5200V. 5300V. 5400V. 5500V. 5600V. 5700V. 5800V. 5900V. 6000V. 6100V. 6200V. 6300V. 6400V. 6500V. 6600V. 6700V. 6800V. 6900V. 7000V. 7100V. 7200V. 7300V. 7400V. 7500V. 7600V. 7700V. 7800V. 7900V. 8000V. 8100V. 8200V. 8300V. 8400V. 8500V. 8600V. 8700V. 8800V. 8900V. 9000V. 9100V. 9200V. 9300V. 9400V. 9500V. 9600V. 9700V. 9800V. 9900V. 10000V.</p> <p>Big Price \$99 <b>SALE PRICE \$749</b></p>	<p><b>SEBO AUTOMATIC 34 Upright Vacuum Cleaner</b></p> <p>34 gallon capacity. 1000 watt motor. 120V. 110V. 220V. 240V. 277V. 380V. 480V. 600V. 690V. 720V. 800V. 900V. 1000V. 1100V. 1200V. 1300V. 1400V. 1500V. 1600V. 1700V. 1800V. 1900V. 2000V. 2100V. 2200V. 2300V. 2400V. 2500V. 2600V. 2700V. 2800V. 2900V. 3000V. 3100V. 3200V. 3300V. 3400V. 3500V. 3600V. 3700V. 3800V. 3900V. 4000V. 4100V. 4200V. 4300V. 4400V. 4500V. 4600V. 4700V. 4800V. 4900V. 5000V. 5100V. 5200V. 5300V. 5400V. 5500V. 5600V. 5700V. 5800V. 5900V. 6000V. 6100V. 6200V. 6300V. 6400V. 6500V. 6600V. 6700V. 6800V. 6900V. 7000V. 7100V. 7200V. 7300V. 7400V. 7500V. 7600V. 7700V. 7800V. 7900V. 8000V. 8100V. 8200V. 8300V. 8400V. 8500V. 8600V. 8700V. 8800V. 8900V. 9000V. 9100V. 9200V. 9300V. 9400V. 9500V. 9600V. 9700V. 9800V. 9900V. 10000V.</p> <p>Big Price \$99 <b>SALE PRICE \$749</b></p>	<p><b>SEBO DART Upright Vacuum Cleaner</b></p> <p>Dart series. 1000 watt motor. 120V. 110V. 220V. 240V. 277V. 380V. 480V. 600V. 690V. 720V. 800V. 900V. 1000V. 1100V. 1200V. 1300V. 1400V. 1500V. 1600V. 1700V. 1800V. 1900V. 2000V. 2100V. 2200V. 2300V. 2400V. 2500V. 2600V. 2700V. 2800V. 2900V. 3000V. 3100V. 3200V. 3300V. 3400V. 3500V. 3600V. 3700V. 3800V. 3900V. 4000V. 4100V. 4200V. 4300V. 4400V. 4500V. 4600V. 4700V. 4800V. 4900V. 5000V. 5100V. 5200V. 5300V. 5400V. 5500V. 5600V. 5700V. 5800V. 5900V. 6000V. 6100V. 6200V. 6300V. 6400V. 6500V. 6600V. 6700V. 6800V. 6900V. 7000V. 7100V. 7200V. 7300V. 7400V. 7500V. 7600V. 7700V. 7800V. 7900V. 8000V. 8100V. 8200V. 8300V. 8400V. 8500V. 8600V. 8700V. 8800V. 8900V. 9000V. 9100V. 9200V. 9300V. 9400V. 9500V. 9600V. 9700V. 9800V. 9900V. 10000V.</p> <p>Big Price \$99 <b>SALE PRICE \$449</b></p>	<p><b>SEBO K7 PET</b></p> <p>K7 series. 1000 watt motor. 120V. 110V. 220V. 240V. 277V. 380V. 480V. 600V. 690V. 720V. 800V. 900V. 1000V. 1100V. 1200V. 1300V. 1400V. 1500V. 1600V. 1700V. 1800V. 1900V. 2000V. 2100V. 2200V. 2300V. 2400V. 2500V. 2600V. 2700V. 2800V. 2900V. 3000V. 3100V. 3200V. 3300V. 3400V. 3500V. 3600V. 3700V. 3800V. 3900V. 4000V. 4100V. 4200V. 4300V. 4400V. 4500V. 4600V. 4700V. 4800V. 4900V. 5000V. 5100V. 5200V. 5300V. 5400V. 5500V. 5600V. 5700V. 5800V. 5900V. 6000V. 6100V. 6200V. 6300V. 6400V. 6500V. 6600V. 6700V. 6800V. 6900V. 7000V. 7100V. 7200V. 7300V. 7400V. 7500V. 7600V. 7700V. 7800V. 7900V. 8000V. 8100V. 8200V. 8300V. 8400V. 8500V. 8600V. 8700V. 8800V. 8900V. 9000V. 9100V. 9200V. 9300V. 9400V. 9500V. 9600V. 9700V. 9800V. 9900V. 10000V.</p> <p>Big Price \$99 <b>SALE PRICE \$1,049</b></p>
--	--	---	--

20449 Hwy. C • Barnett, MO 65011  
www.topstitchsewing.net

**Top Stitch**  
Sewing Services LLC  
BERNINA - SWISS MADE

Sat. 8-4pm  
Tue.-Thu. 8-5pm  
Fri. 8-4pm

**573-378-2700**

MasterCard, Visa, Discover, American Express

# ARE YOU STRUGGLING WITH

- Headaches
- Being Fluffy
- Stiff Joints
- No Energy
- Low Moods
- Foggy Mind
- Not Sleeping
- Hair Loss

## YES I DID TOO!

### YOU'RE THINKING ...

- But I tried it all!
- Works for you but not for me!
- I eat healthy!
- They all say it works!

I have tried a lot of different things and bought the products, took a couple rounds and there it sat! So saying my husband was a skeptic is an understatement! Do you blame him? I don't. I wasted so much money. However, when you feel different after you take the product, you actually take it!

I was able to reduce my medications and have less pain, and I sleep amazingly at night!

My side effects have been losing 30 pounds in the last year, no I don't diet ... I do love pizza! Another side affect is my hair growth has been crazy.

I just finished a 28 day detox and lost 13 pounds and 20 inches.

Are you ready to take your life back and give it the tools to work how GOD created it to work?

For more information call  
Clara Helmuth or Rose Mullet  
847-807-5710

My idea of Christmas, whether old-fashioned or modern, is very simple: loving others. Come to think of it, why do we have to wait for Christmas to do that?

~Bob Hope

## Promotional Products Help You Get More Repeat Business.

When you thank your customers with branded promotional items, they'll keep you in mind and your repeat business will grow!



*"Promotional products are great. They get our name out where others can see it, bring in repeat business, and customers are thankful to receive them."*

-Lamar, Farmersville Butcher shop



**LITTLE MOUNTAIN**  
**PRINTING**  
Home Of  
*The Fishwrapper*

Call for a FREE Catalog!  
**717.933.8091**

info@littlemountainprinting.com



### Lighten the load with our well balanced compact PTO FORECARTS

- Standard Features**
- 35 hp Vanguard engine
  - Sliding axle
  - Torsion suspension
  - Rubber isolators on engine and platform

#### Dealers

Pennsylvania  
**Discbine Doctor** ..... 717-768-7542  
Ohio  
**Farmers Equipment** ... 330-897-1106  
New York  
**A&R Repair** ..... 518-993-4862

phone: 231-734-9745





## PERSONALIZED DECALS

on Kulz for Customer Appreciation,  
Employees & Gifts for Everyone!



5 Year Warranty

# Made To Order!

ZIP-LINE  
**KULRZ**  
20 Quart

## LASER ENGRAVING

A Beautiful Long-Lasting Gift for Christmas,  
Weddings, Employees  
and More!



UP TO  
**24 HRS  
COLD**

UP TO  
**12 HRS  
HOT**



22 oz.

**NEW  
JUMBO  
SIZE!**  
315 Quart  
Cooler

**KULRZ**  
for Task and Sport

- 7 Size Options  
22, 39, 65, 96, 145, 190 & 315 Qt.
- Virtually Indestructible Construction
- Deep Insulation Retains Ice Longer
- Freezer-Quality Gasket Design
- Tie-Down Slots for Travel
- Heavy-Duty Rubber Lid Latches
- Non-Slip Bottom
- Convenient Drain System

**JUGZ**

- Triple Insulated Extra Thermal Lining Retains Temperatures
- Dishwasher Safe
- Vacuum Sealed
- Premium Stainless Steel
- Spillproof Screw-in Lid
- 1 Year Warranty



40 oz.



18 oz.

**ORDER NOW BEFORE  
THE CHRISTMAS RUSH!**



103 Springhead Rd. Gap, PA 17527

**877-686-5464**

**WHOLESALE Inquiries Welcome!**

84 oz.



1 Gallon

**LASER ENGRAVING  
AVAILABLE AT THESE RETAILERS:**

Honey Brook Hardware	Ideal Engraving	Davco Advertising
610-273-3724	717-929-1521	717-442-8660

**Steam Comic Books**

# CAD BY KARL

Now offering pole barn component lists to help you in your estimates.

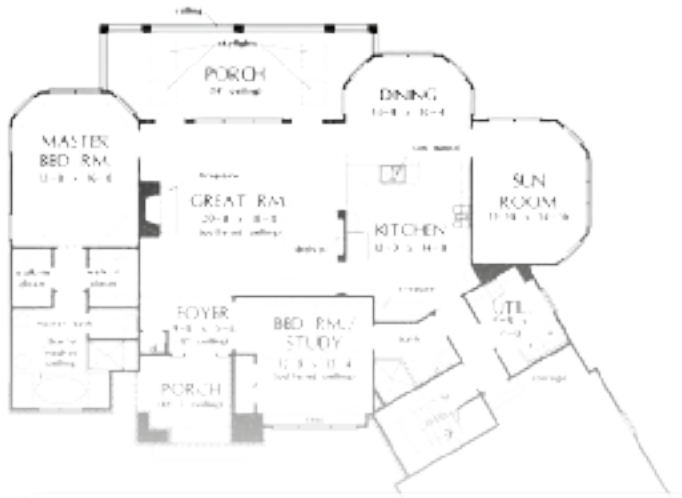

Helping you bring dimension to your project.

Karl

Draftsman

Office/Cell 301 730 8548

Fax 681 247 9593

We can help you with your church or school project

We can help you with the process from preliminary concepts through complete construction drawings

36 Orrick Riner Lane  
Martinsburg, Wv 25403

# PINE LOGS WANTED

Needs to be good quality white pine, will also buy standing pine. Prefer large quantities. No yard trees.

Please call - **RIVER VALLEY PINE**  
440-693-4572 ... Leave a Message

# Sunset Supply LLC

717-626-2194

## NUTRA-GLO™

Nutritional Feed Supplement (Liquid Products)



Available at:  
Harness Shops, Blacksmith Shops and  
Feed Stores Everywhere!

The 1<sup>st</sup> Choice  
Supplement of hundreds  
of today's horse owners, dairy  
farmers, veal & poultry producers  
and deer & dog breeders!



## Improves

- Nutrition & Digestion
- Immune System
- Reproductive Health
- Hair Coats
- Hoof Quality
- Muscle Tone
- EPM



Power Pac



## DIVINE EQUINE

### Natural Supplements

Discover Your Herd's  
Maximum Potential!

What do customers say? "Most effective all natural products"

It works!  
Our 3-year-old horse had no pulling power in the hind legs and was skinny and narrow. After feeding Glorify and Nutra Glo, he is gaining weight and driving with snap and energy. Thank you for two great natural products that work!  
- The Zimmermans  
Lancaster, PA

805 Log Cabin Road, Leola, PA 17540

## PORTABLE BAND SAW MILLS

### EZ BOARDWALK

MORE SAW FOR LESS MONEY!

Call  
660-415-7800  
for pricing & brochure

- 20 ft. track made from 6" channel (4', 6', and 8' extensions available)
- trailer package available
- cuts on an angle for easy operation
- 4 quick-clamp log dogs
- auto blade lube
- cuts 40" x 16"6" logs
- spring assist lift

Delivery Available  
NO SUNDAY CALLS



Smaller Mill  
"EZ Boardwalk JR."  
13 HP Honda  
Cap: 30" dia. x 12'2"

8218 SHELBY 366, EMDEN, MO 63439 • 660-415-7800 | [www.ezboardwalk.com](http://www.ezboardwalk.com)



# NEED MORE SPACE?

Call For All Your Storage Solutions!

## PALLET RACKING

- New and Used
- Different Sizes Available
- Custom Heights
- Choice of Decking



## NEW CANTILEVER RACKS

- Heavy Duty 2,625 lb. per 4' Arm
- Light Duty 1,000 lb. per 4' Arm

## RIVET SHELVING

- 225 lbs. per Shelf
- 48"W x 20"D x 84"H

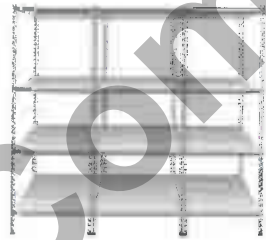

ASK ABOUT CUSTOM SIZING

**Yoder's Produce**  
INC.



9595 APPLE CREEK ROAD  
FREDERICKSBURG, OHIO 44627  
330.695.5900

"THE LAST BATTERY YOU'LL EVER BUY"



LIFETIME WARRANTY

## SOLAR-IN-A-BOX

- LIFETIME WARRANTY
- ALMOST 10 LBS LIGHTER
- STRONGER/MORE CAPACITY
- IN-STOCK & SHIPS FAST!
- COMPETITIVE PRICE!

MENTION THE PCBE - \$100 OFF  
**877-782-7707**

ASK ABOUT SOLAR ADD-ON | 20 WATTS & UP | PORTABLE  
PLUG-N-PLAY - CHARGE BATTERIES - RUN FAX & APPLIANCES

## THE GLENWOOD.

Efficiently heat from your choice of fuels



### Automatic Multi-fuel Boilers and Furnaces

- Wood, coal, oil, waste oil
- Indoor/Outdoor Applications
- The best in gasification technology
- Sizes from 100,000 BTU thru multi-million



### Automatic Self-modulating Coal Stoker

- An exciting new blend of electronic technology and good old-fashioned rugged engineering
- Super-high combustion and heating efficiency



### Biomass Boiler

Taking multi-fuel to a new level

Efficiently burn shavings, woodchips, chopped hay, chicken litter, used horse bedding, wood, trash, coal, and more!

### ECONO - FLAME



We specialize in alternative energy heating systems.

Call us for all your heating needs and let us help you burn your heating bill instead of your money! No job too large or too small.

**GLENWOOD HEATERS**

Call: (717) 587-1696

### High-Efficiency Boilers and Furnaces

Burn Waste Oil, Cooking Oil, or Heating Oil

## Self Inking Stampers

- Return address • Check deposit • Date • Name
- Square • rectangle • round • over 20 different sizes

## Name Tags

Plastic • Metal • Wooden • Interior • Exterior

Keep advertising, long after your product sells.  
Use Name Tags to put your name on the things you sell.



return address stamper  
3/4" x 1 7/8" only \$21.00  
+ \$4.00 S & H  
(NY add \$2.00 tax)

Custom Laser Engraving  
4762 State Route 14a Dundee NY 14837  
Phone 607-243-7150

Call now for your free brochure

# PRODUCING SWEET CONFECTIONS

AT



LERDY MARTIN

**INSIDE YODER'S RED BARN SHOPPES** in Shipshewana, Indiana, local folks and tourists alike often find a solution to their sugar cravings. Since August 1st of 2017, Junior and Martha Yoder and family have been operating the Victorian Candy Company, which is located on the second floor of the Shoppes. (Junior and Martha Yoder do not own Yoder's Red Barn Shoppes).

Making candy is something of a sweet dream come true for the Yoders. I believe you will agree with this upon hearing more of their experiences.

Each week, the Yoder family produces fresh batches of various flavors of fudge as well as brittle brackle in their candy kitchen in the Shoppes along Van Buren Street. The street brims with traffic, and the area seems like a prime spot in which to sell candy and other sweets. If the busy confectioners allow themselves to pause for a moment from mixing batches of sweet treats, in retrospect, Junior and Martha can hardly believe how their candy business actually became a reality.

The Yoders had seen an ad in the local papers in 2017 that stated a candy business was for sale in northern Indiana. "The business was located inside a store we had never been to, although we were familiar with the general location," Martha explained.



A few days after seeing the advertisement, the Yoder family attended a social event which was held in the town of Shipshewana. It was a cold day, and the Yoder children became cold during their time outdoors. “I hadn’t brought enough of heavy coats along for them,” Martha said. “I noticed a nearby store was open, so I took the children inside to warm themselves for a bit. Upon entering the store, I realized that the candy business which we had seen advertised was also located there.”

Immediately upon glancing at the candy operation, Martha knew she liked what she saw. “I had been making candies at home for the family during the winter,” she said. “But I couldn’t quite imagine myself as a candy maker. Even so, my husband Junior and I knew that we wanted to give candy making a try.”

After speaking to the owners of the candy operation as well as several banks, regarding the finances and start-up costs associated with a business, the Yoder’s dream of producing sweets appeared to melt away like cotton candy on a warm day. “We just couldn’t afford it, there was no way,” she remarked.

“Our situation was rather embarrassing,” she continued. “We decided that we need to tell the owners that we can’t even make an offer for their business. My husband walked into the store to explain our situation. However, upon listening to my husband’s explanation, the owner presented him with an offer we couldn’t believe. The offer that she presented to us was very affordable, and Junior and I quickly decided that we will purchase the candy company after all.”

Had the Yoder children not gotten cold the day that they attended the social event, and the family hadn’t gone inside the Shoppes to warm themselves, “we would very likely never have discovered the candy store and would not be making candy now,” Martha exclaimed with a smile.

Since the acquisition of the confectionary, the Yoders have made hundreds of batches of handcrafted candies. The production—and marketing of their candies— was a challenging experience for them, since they were starting

afresh, with no established customer base to follow their acquisition.

“A few people stepped inside the candy shop every now and then,” Martha related. “It wasn’t very busy, initially. We decided to remodel the kitchen in our production



A display counter at Victorian Candy Company.  
Image Credit: Leroy Martin

facility and were intentional about having an open space that would provide any customers that browsed our shop with an opportunity to observe us as we produced our handmade candies.”

That idea itself might have been among the most important business decisions they made. When people noticed that they had the opportunity of watching candies being produced, it really sparked interest, and pretty soon what had been a slow trickle of customers grew to a sizable, curious crowd of observers, who were all too eager to appease their sweet tooth.

“That substantially increased our customer base,” Martha said. “People really enjoyed watching us work.”

Brittle brackle is a candy that is somewhat temperamental to produce, according to Martha. Even so, they had begun

*Victorian Candy Company - Continued on Page 228*

### *Victorian Candy Company - Continued from Page 227*

operating their production lines by focusing on producing this challenging candy. Later, in November of 2019, after some experimentation in their home kitchen, the Yoder family produced their first batch of homemade fudge, which they began selling at the store.

“During the first twelve months of our fudge production, we sold more than one ton of fudge,” Martha remarked, to my surprise. It was a popular, highly sought-after candy, as the revenue indicated.

Prior to producing their own fudge, the Yoder family had purchased fudge from a wholesale confectioner. “As soon as we began producing our own, we knew we needed to continue. Each year since 2019, the amount of fudge we sell has increased by seven hundred pounds.”

In 2021, Victorian Candy Company could very likely sell in excess of one and a half tons of their homemade fudge.

“We sell thirty different flavors, but we only keep twelve to fourteen flavors on the counter at one time. Providing seasonal flavors is something we are intentional about,” she said.

During my visit in late summer, two of the seasonal flavors they offered were Root Beer Float and Watermelon.

“Throughout the winter months, we feature Chocolate Amaretto, many different Coffee flavors, and of course Peppermint,” she added. “Peanut butter is probably our most popular flavor, but Chocolate is also a favorite among many.”

Victorian Candy Company also makes and sells their own

chocolates. The first winter that they were in business, the Yoder family began experimenting with making their own chocolates.

Majority of the equipment that they use for the candy production was included in the acquisition of the business. Only a few recipes, however, were included. The Yoders were left with figuring out how to make handcrafted candies largely on their own.

Martha had some limited experience in candy making and had been crafting homemade candies for her family and a short list of friends and relatives each winter. “I also made some candies for our children to take along to school, where they would distribute it to their classmates. I made the candies just for fun,” she recalled. “I always enjoyed it, but I never imagined I would someday be making candies for customers.”

The temperamental yet tasty brittle brackle is mixed in a kettle in Victorian Candy Company’s production facility. Both wet and dry ingredients are introduced to the mixture at the appropriate times. Achieving and maintaining an ambient temperature is crucial; the temperature must be exact.

“Once the brittle brackle has completed the mixing cycle, an exact temperature must be achieved before we can begin pouring the hot mixture onto the conveyor belt,” Martha explained. “If the mixture isn’t poured at the exact desired temperature, the batch will be too soft or too hard.”

“The mixture will then pass under two rollers, where the first one flattens it and the second roller cuts it,” Junior explained. “The conveyor belt will transport the mixture to

Brittle brackle is emptied from the mixing bowl onto the conveyor belt.

Image Credit: Leroy Martin



Fresh brittle brackle emerges underneath the rolling pins.

Image Credit: Leroy Martin





a cooling unit, where it remains for thirty minutes.”

Sometimes chocolate is drizzled onto the mixture after it is cut. If the recipe calls for a drizzle effect, it is applied while the candy is cooling. At the completion of the cooling process, the brittle brackle is then placed into individual packages and placed on the shelves of the candy shop.

“It’s called brittle brackle, because it is somewhat softer than typical brittle,” Martha said, providing an explanation to the question that had been floating around in my head. Prior to my visit, I had never heard of brittle brackle. Perhaps I should have spent more time in candy shops throughout the past few years.

Producing fudge is less challenging than their popular brittle brackle, the Yoders assure. “This is also mixed in a kettle, and usually takes approximately thirty minutes to produce a batch, which consists of thirty-six pounds,” Martha explained. “Fudge should never be heated in excess of 150 degrees.”

She typically removes six pounds of fudge from the kettle at a time, and then works the fudge into the pans in six-pound increments.

All fudge that is produced here begins as a plain or chocolate flavor. “With six pounds of plain fudge, I can easily add whatever flavors and colorings that I want to. I can add chocolate as necessary,” she added.

“Fudge is never lost,” Martha said with a chuckle. “It’s hard to mess up a batch of fudge. But if, for some reason, it doesn’t turn out just right, it can always be remedied. You can reheat it and rework it into the next batch.”

Victorian Candy Company also produces and sells freeze-dried candies. That type of candy currently is trending. The Yoders recently purchased a freeze dryer, and they place Skittles, Starburst, salt-water taffy, and other candies into the unit.

“How we were introduced to freeze dried candy is interesting. We purchased some candy from a wholesale supplier, and I noticed that they were selling a freeze-dried ice cream sandwich. It raised my curiosity, so I bought one. Eating it was a unique experience, so after we spoke with a friend of ours who had a freeze dryer, we began experimenting with various candies.”

The candy is placed inside the unit, sometimes for many hours, depending on the type of candy. Inside the unit, the candy is subjected to inhospitable temperatures as low as 140 degrees below zero. To complete the process of freeze-drying candy, humidity is also removed from the air within the unit itself. The result is a candy which doesn’t quite resemble its original shape or texture. For example, when I tried the freeze-dried salt-water taffy, the experience was similar to eating a malted milk ball; crunchy and powdery. That is definitely not a statement you could accurately make when eating salt-water taffy that hadn’t been subjected to such harsh treatment.

Chocolate covered potato chips, chocolate covered gummy worms, and pretzels are also produced by the creative Yoder family. Large peanut butter cups, with each tipping the scales at half a pound, are also available for purchase. “We use our own peanut butter mixture for these,” Martha

*Victorian Candy Company - Continued on Page 230*

Brittle brackle, prior to undergoing the cooling process.  
Image Credit: Leroy Martin



Brittle brackle, after undergoing the cooling and drizzling process.  
Image Credit: Leroy Martin



*Victorian Candy Company - Continued from Page 229*

offered as I picked on from the shelf. For those who dislike peanut butter, a caramel cup—weighing one pound—might be just the thing to command those sugar cravings to submission.

“Our daughter Kaitlyn suggested that we begin making these large caramel cups,” Martha explained. “Our son Christopher came up with the idea of making candy trains. He enjoys making the trains and utilizing his imagination.”

Roasted cashews, almonds, and peanuts are a favorite among many customers. Victorian Candy Company began producing and selling roasted nuts recently. Seventeen minutes and a little bit of cinnamon and a touch of sugary glaze is all that is required to produce this quick, satisfying treat. On roasting day, the pleasant aroma is sure to greet you immediately upon stepping foot into the candy shop.

The Yoders and their three part-time employees produce

handcrafted candies each day. “Our employees are scheduled on different days, they don’t all work here in the facility at the same time,” Junior explained.

After filling several bags with homemade candies, I asked the Yoders if I should perhaps provide a disclaimer to our readers. “I am assuming you are not responsible for any cavities that customers might incur, or are you?” I had asked.

“No, we aren’t not,” Martha replied with a chuckle. “It might be good for your readers to know,” she added.

*Junior and Martha Yoder and Family own and operate Victorian Candy Company. They have a growing number of candies in stock, and if you are interested in placing large or small orders for Christmas dinners or events, please reach out to them by calling: 260.768.3272. 457 S Van Buren Street Shipshewana IN 46565. Expedited shipping of candies is available for an additional cost.*

Researched, written, and edited by *Leroy Martin* for the exclusive use of the *Plain Communities Business Exchange, LLC*.



A giant peanut butter cup is topped with layers of chocolate.  
Image Credit: Leroy Martin



The fudge manual at VCC production facility.  
Image Credit: Leroy Martin



Freeze-dried salt water taffy is an unusual treat.  
Image Credit: Leroy Martin



Fudge is carefully cut on the production table.  
Image Credit: Leroy Martin



# Demo Days & Customer Appreciation Sale

WEDNESDAY, DECEMBER 15<sup>TH</sup> 2021 *Free BBQ Lunch & Ice Cream... Plus Door Prizes!*

6161 Mt. Hope Rd - Apple Creek, OH 44606 - 330.778.0020 - AWMachineryLLC.com

**12+ Factory Reps On-Site... Demos on These Machines & More on Display!**

**AW Machinery**  
INDUSTRIAL WOODWORKING EQUIPMENT

**STO-JDT75** Automatic Dovetailer

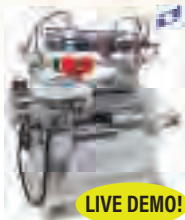

LIVE DEMO!

**C1-02** Automatic Twin Table Slot Mortiser

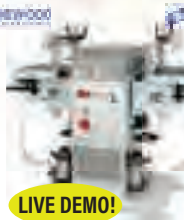

LIVE DEMO!

**C1-K6** Automatic Twin Table Round End Tenoner



LIVE DEMO!

**GY Series** Auto Double Surface Planers



LIVE DEMO!

**Cardan Shaft Transmission**

**STO-735M** Heavy Duty 1-1/4" Shaper



LIVE DEMO!

**S-1000 Series** Dust Collectors



LIVE DEMO!

**S Series** Calibrating Sanding Machine



LIVE DEMO!

**Door Prizes Win BIG!**

**30+ Machines with Live Demonstrations**

**100's of Machines In-Stock & Ready for Immediate Purchase and Delivery**

**Storewide Savings & Promotions!**

**Rotary Door Master 5 & 8** Section Door Assembly



LIVE DEMO!

**SRX Hydraulic Clamp Carrier**



LIVE DEMO!

**LM116** Easy Lock Miter



LIVE DEMO!

**M312** Easy Drawer Notcher

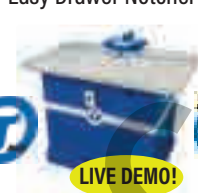

LIVE DEMO!

**C117** Easy Coping Single Spindle Machine



LIVE DEMO!

**QUICK CHANGE!**

**EC Glue Conveyor & Applicator**



LIVE DEMO!

**Drawer Master** Drawer Assembly Clamp



**#1 Seller**

LIVE DEMO!

**DOUCET**

**Compact Plus** Vertical Panel Saw



LIVE DEMO!

**Z-Series 1000** Pneumatic Lifts

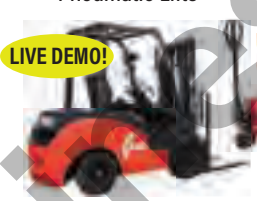

LIVE DEMO!

**T-CBD25T/30T** Electric End Control Pallet Truck



LIVE DEMO!

**T-DF-III** Hand Pallet Truck

**SL-52** Remanufactured Straight Line Rip Saw



LIVE DEMO!

**Stonewood Return Conveyor**

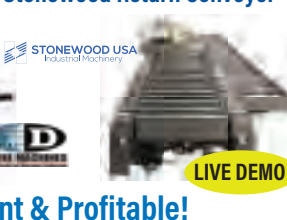

LIVE DEMO!

**Lean, Efficient & Profitable!**

Reduce a three-person system to just two! With our system, there is as little contact with the boards as necessary. Truly a highly efficient system to process and glue up panels!

*A fully customized solution!*

**SE-1CNC-D-PS** Single Spindle Dovetailer



LIVE DEMO!

**SE-25CNC-TS-PS** Single End Dovetailer



LIVE DEMO!

**HP5D** Pillar Door Machine



LIVE DEMO!

**RAZORGAGE**



LIVE DEMO!

Measuring Systems

**WL 600** Shredder



LIVE DEMO!

**Tiger 400, 600, 800** Shredder



LIVE DEMO!

**D405ANC** 1-Axis Sliding Table Saw



LIVE DEMO!

LIVE DEMO!

**MRS300** Multi Ripsaw

**Arctic Mist Industrial High Pressure Humidity Control System**

No Dripping... No Wet Spots  
Fully Auto Controlled  
100% Satisfaction Guaranteed  
3-Year Warranty  
Fully Humidify 20,000SF for under \$10,000!



LIVE DEMO!

**Zeta P2** Quick Locking Biscuit Joiner/Lamello P-System



LIVE DEMO!



# GROWER AND RETAIL BENCHES FOR THE GREENHOUSE AND NURSERY INDUSTRY



**New Style of Tops Available. Better Design to Attach to your wool frame.**

- Less Expensive
- Increased Airflow
- Easier Cleaning

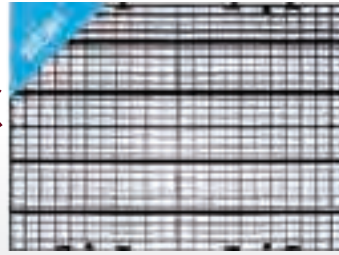

**NEW SIZES 36" x 48"**  
As low as 1.60 a square foot

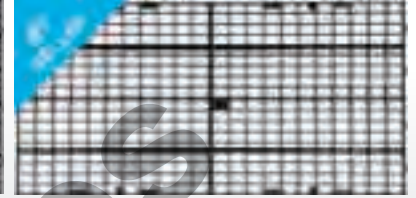

**24" x 48"**  
As low as 1.65 a square foot

Benches are constructed of fiberglass channel & put together with stainless steel hardware!

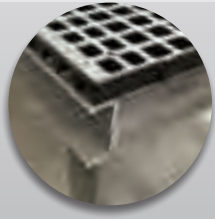

Fiberglass channel available in ● Gray and ● Tan

- Easy to install • UV Protected
- Strong, durable and lightweight
- No rot, rust or decay
- Flats, trays and pots slide easily



**Display Benches Available** with or without Basket rails

65 Mill Street  
Mill Hall, PA 17751  
**(570) 502-1747**

[lifetimebenching@outlook.com](mailto:lifetimebenching@outlook.com)



**We ship Nation Wide!**

**CALL FOR A FREE QUOTE!**

# FORKLIFTS FOR SALE

## Service, Parts and Rentals

This is just a partial listing. Call for full list.



**JCB**  
940  
8,000 lb. cap.  
1,015 hrs.  
2020 Diesel  
**\$75,000**



**JCB**  
940  
8,000 lb. cap.  
4,833 hrs.  
2014 Diesel  
**\$43,000** UNIT #2915



**Hyster**  
H60XM  
6,000 lb. cap.  
13,321 hrs.  
2000 LPG  
**\$11,700** UNIT #2907



**Toyota**  
8FD40U  
9,000 lb. cap.  
8,682 hrs.  
2018 Diesel  
**\$29,900** UNIT #2023



**CAT**  
R80  
8,000 lb. cap.  
17,000 hrs.  
2009 Diesel  
**Call for Price** UNIT #2020



**Hyster**  
J40XNT  
4,000 lb. cap.  
10,309 hrs.  
2015 Electric 48V  
**\$8,700** UNIT #2916



**Toyota**  
7BRU23  
4,500 lb. cap.  
3,100 hrs.  
2005 Electric 36v  
**\$7,900** UNIT #2911



**Nissan**  
MYG1F2A30V  
6,000 lb. cap.  
9,842 hrs.  
2015 Diesel  
**\$20,700** UNIT #2022



Formerly Parke County Diesel LLC

Shipping Available

6064 N 350 E • Marshall, IN 47859

**765.597.2473**

Financing Options Available





## Hope For Your Health

I have no memories of not being overweight. All through my childhood and teen years I was obese. I didn't believe things would ever be different for me.

In 2020 one of the guys in church completely transformed his life and lost 120 pounds! And he was a lot older than I was. I decided if he can do it, so can I.

In September 2020 he started coaching me and I simply couldn't believe what began to happen. In six months I lost 100 pounds and absolutely feel like a new man.

I am no longer overweight. In fact for the first time in my life I can honestly say "I am thin".

I can't believe I'm saying that because it was so far out of reach for me. Needless to say, I love this program, it's easy, it's fast and it's healthy.

I am now helping my friends take their health back. If this is something that interests you, call or text me.

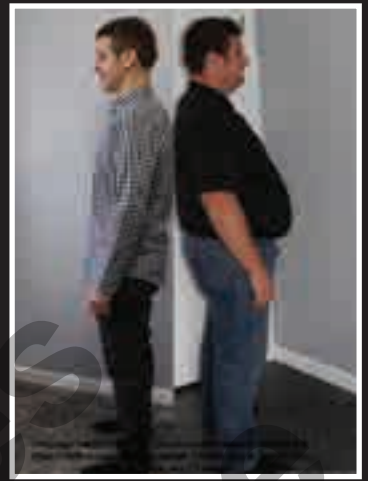

## "Off to the Races"

This plan has allowed me to get into the sport of running, I am currently running *5k races* and *1/2 marathons*.

**Willis Yoder**  
**330-275-2945**

728 Glenwood Drive, Ephrata, PA 17522

# Zimmerman

## Auto Body Supplies Inc.

1-800-933-8422  
www.zabscars.com

*Our Finishes Reflect Your*

**SATA**  
**DEVILBISS** AUTOMOTIVE REFINISHING  
**U-TECH**  
**BINKS**  
**NORTON**  
**DYNABRADE** **3M**

**Ask For Our Free Catalog...**

Sales  
Service  
Delivery  
Technical Support

**Craftsmanship!**

Cabinet, Woodworking & Manufacturing Shop Supplies,  
Tools, Spray Equipment, Sandpaper, Personal Protection &  
Safety Materials, Paint Supplies & Industrial Solvents,  
Spray Booth Filters, Custom Cut Air & Fluid Lines

**Pick... Any Color!**





For an extremely durable, high tech liquid coating, partner with Hentzen Coatings.

Our coatings are custom engineered by chemists and technical specialists who pursue solutions to corrosion, weatherability, aesthetics and durability.



The formula for performance coatings

ALLEN CORNELIUS, Technical Service Representative  
CELL (330) 275-0476 • acornelius@hentzen.com

Hentzen Coatings Inc., Corporate Headquarters, 6937 West Mill Road, Milwaukee, WI 53218-1225 • www.hentzen.com

## Classic Steward Word Processor

By Conservative Technology Services

Keep your office organized and efficient!

- ⊗ 2D and 3D CAD
- ⊗ LibreOffice 5.2
- ⊗ Comprehensive organizer/scheduler
- ⊗ PDF Viewer
- ⊗ Networkable for Classic Accounting, file sharing, and printer sharing



### Classic Accounting<sup>®</sup>

An accounting system that does everything you need, but is still intuitive and easy to use. Meet Classic Accounting!

- ✓ Expense entry interface, it just makes sense
- ✓ Invoicing and billing, built into the system
- ✓ Detailed reports, custom reports available
- ✓ Use on any word processor or spreadsheet
- ✓ Networkable for multiple users and locations

The "Mini"  
Very economically priced, can run directly off of 12VDC, all the capabilities of the standard model with less brown.

Conservative Technology Services is a non-profit organization offering solutions for individuals and church groups that are concerned about modern internet use and connectivity. For more information contact Allen at 717-445-0408



Contact a dealer for info or sales

- |                                 |              |
|---------------------------------|--------------|
| Classic Sales & Service - PA    | 717-733-8948 |
| Jeremiah Rizer - IN             | 574-862-1795 |
| Joseph Miller - OH              | 740-502-0867 |
| Brubakers Sewing - WI           | 715-229-2851 |
| Zimmerman Office Solutions - MO | 573-378-6673 |
| Michael Kilmer - MD             | 417-876-2418 |
| Altech Enterprises - PA         | 717-445-0408 |
| Sunrise Circuits - KY           | 270-881-4177 |

**Bender's**  
2-CU  
Safety Flag



**\$73<sup>77</sup>**

**NEW & IMPROVED!**

Each strobe is powered via optional sources of either: 4 'C' batteries A standard 12 volt battery • "The Buggy Buddy" • 4 'AA' batteries  
**Bender's 2-CU Safety Flag** is designed for low profile slow moving vehicles such as pony carts, wagons, scooters and bicycles.

**BENDER'S BUGGY SHOP • Robert R. Bender, Sr.**  
5524 Barryville Rd. • Nashville, MI 49073 | 517-852-0671

## New Dutch Maid Wringer Washer

— Now Available —



- Tub skirting and legs made of a poly material (will not rust)
- All parts interchangeable with the Maytag Model E Wringer Washer

Please ask your local Magtag Dealer for details.

**C&M Maytag**

506 Hensel Road, Kinzers, PA 17535  
717.442.9781 - 8:00am - 8:30am, Monday - Friday

Stay In Control Of Your Heart...

Try  
**Artery  
Care!**



3 HIGH STREET • MYERSTOWN, PA 17067

800-668-7373 • 717-933-4554 • Fax: 717-933-4557

Email: uni7067@gmail.com • uniservices.health

## USED FABRIC STRUCTURES

**2 BUILDINGS  
70' X 238'**

**CALL: 660-486-3250**



# WOOD SPLITTER



**\$3995<sup>00</sup>**

**Year 2021 - New Design - New Model**

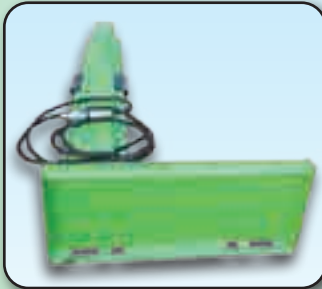

It is an Extreme very heavy duty model

- 30 inch opening
- 30-ton hyd cyl
- Offset Boom for better vision to see your work better.
- It has an upside-down boom so you can stay in your skid loader in comfort all day long.

## MARTIN EQUIPMENT & SALES

1375 Lower Clover Creek Rd, Williamsburg PA 16693

**814-832-2306**

melvinjomartin@gmail.com

# WE DO CUSTOM LASER CUTTING AND SHIP ALL ACROSS THE STATES

We offer in house design, If you can draw it we can cut it. Fax, mail, or email your hand drawings or dxf files (if you have them) and we will make it happen.

**Short lead times**



State of the art Fiber laser technology up to, 3/4" mild steel capacity.

## ARK PRECISION CUTTING LLC

N689 County Rd B, Kewaunee WI, 54216.

**Phone (920) 304-9267 Fax (920) 375-5051**

**E-mail: orders@arkprecision.com**



## CLEANING SOLUTIONS FOR YOUR

**BUGGY + HARNESS + TRUCK  
DOG KENNEL**

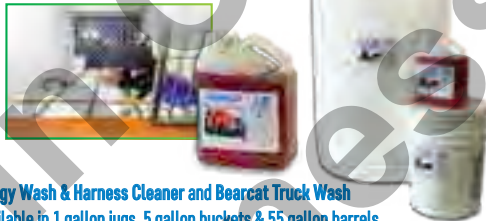

Your Source for Eco-Friendly, Highly Effective, Easy to Use Cleaning Solutions

Buggy Wash & Harness Cleaner and Bearcat Truck Wash Available in 1 gallon jugs, 5 gallon buckets & 55 gallon barrels

717-250-4403 | info@CDIecoclean.com | www.CDIecoclean.com | Mark Yoder, Owner

## MECHANICAL LOG SPLITTERS

### Proven Rack & Pinion Design

- Standard with 24" stroke
- Now available with 34" stroke

**\$2,850<sup>00</sup> plus shipping**

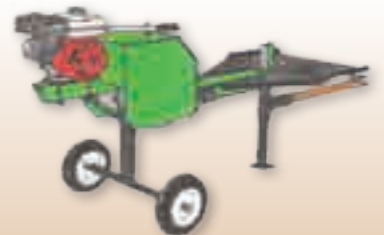

**DEALER INQUIRIES WELCOME**

**RETAIL and WHOLESALE**  
Write for dealer pricing and delivery options.

For more information or brochure write:

**FLACK HILL MACHINE**  
7671 SR 514 • Big Prairie, OH 44611

The Ultimate Data Processor

## PIONEER

Writing, spreadsheets, drawing  
CAD designing for CNC machines  
Accounting and record-keeping

Paperless faxing - no need for fax machine  
Comes with cordless keyboard and mouse

Network connection for accounting, printers and file sharing  
Secure operating system - no internet, games, movies or sound  
Optional programs available: advanced accounting, advanced CAD drawing, mapping, encyclopedia, parts lookup, publishing, etc.  
Newly upgraded system - better software compatibility and security

**Pioneer Electronics**

2657 Keech Rd Branchport NY 14418

Call for free brochure!

Phone/Fax 315-536-7464



## 1228-A Coil Tipper

- 12,000 pound capacity
- Needs no power to operate
- Smooth and easy to use

We also manufacture  
**Slitters and Flat Sheet Racks**



Custom Machining and Fabrication  
**Maple River Machine**

1105 Plains Road, Brutus, MI 49716

(231) 539-7022

## What our *Diamond Grill* customer are saying

I like the auto wood and coal igniting. I love my *Diamond Grill*. Indiana, M.G.

I like the fact of a small amount of pecan, apple etc. wood to flavor the meals.

Michigan, M.B.

If anyone ask's me how I like my *Diamond Grill* the answer is we use it for all three meals on some days. Bacon, eggs, pancakes, steaks, whole chicken, pizza, brownies the list is endless!!! Very nice and dependable.

Indiana, J.Z.

I love my *Diamond Grill* period. Smoking, grilling, frying, you name it. Indiana, K.L.



The *Diamond Grill* is like five different grills in one unit - Green Egg - Flat Top Griddle - Charcoal - Wood - Gas - and will last a lifetime.

Wisconsin, J.G.

The *Diamond Grill* is easy to use and serious about making heat I can make a meal in no time flat. Indiana, L.G.

L.G.

**M&L Appliance | 260.609.9602**  
13534 Stellhorn Road, New Haven, IN 46774

Call for more information!  
Retail and Wholesales Available

## INTRODUCING

### REDMOND 10 FINE WITH GARLIC

PREMIUM MINERAL SALT



- Natural fly control.
- Helps to control flies, lice, and ticks.
- Antioxidant properties.

#### Garlic Worth its Salt for Fly Control

\*Approx. 55% Reduction in Fly Counts vs. Control Groups  
\*Cattle Avoidance Behaviors Reduced Significantly

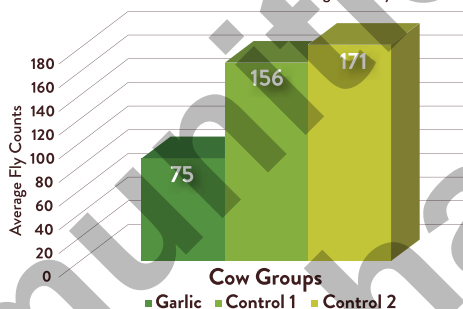

Saskatchewan Ministry of Agriculture. 150 cow/calf pairs in 3 groups in close proximity to each other, two control groups on trace mineral salt and one treated with garlic powder.



Toll-Free: 866-735-7258 • [redmondagriculture.com](http://redmondagriculture.com)

#### NARROW BELTS



#### WIDE BELTS



#### DISCS



#### SHEETS & ROLLS



#### FLOOR SANDING

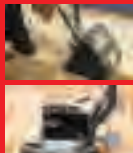

## ABRASIVE MANUFACTURER OF SANDING BELTS, DISCS, SHEETS & ROLLS



- OVER 30 YEARS OF MANUFACTURING & SUPPLYING THE WOOD, METAL & FLOORING MARKETS.
- UNBEATABLE PRICING.
- FREE SHIPPING ON ALL ORDERS (\$100 MIN).
- MANY ITEMS IN STOCK FOR SAME/NEXT DAY SHIPPING.
- MAKE ORDERS SHIP WITHIN 3-5 DAYS.
- WE MAKE BELTS IN ANY SIZE - THOUSANDS OF DISC & SHEET DIE CONFIGURATIONS.
- LARGEST PRODUCT OFFERING TO ENSURE THE RIGHT PRODUCT FOR YOUR APPLICATION.

WE NOW TAKE CREDIT CARDS



Additional fees apply



**PRODUCTION ABRASIVES, INC.**

46 SHEESLEY WAY  
HAMILTON, PA. 15744

TOLL FREE: 800-784-6572 • FAX: 814-938-3293

## YOU CAN COUNT ON US FOR ALL YOUR WOOD CUTTING AND METAL CUTTING BANDSAW NEEDS!



**LENOX**

**Wood-Mizer**

*From forest to final form*

**BAHCO**

**WIKUS**

*Precision at the cutting point*

Call Chris O'Neil • 231-527-8325

[chris@smithsawmillservice.com](mailto:chris@smithsawmillservice.com)

Smith Sawmill Service

P.O. Box 510, Garrison, TX 75946



# STOP Wasting Time!

## TRY THE Sunnyburn Bell Timer

Powered by 12 Volt Battery



Employees agree that one area of waste in their business is employee downtime. Just 1 or 2 lost minutes at lunch, break and quitting time add up over time and are a source of waste in your shop!

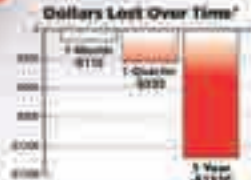

**Control & 1 Bell**  
**\$390**  
 Extra bells \$60 each

Manufactured by  
 Virgil Roberts, son of the late  
 Emanuel Esh, owner of  
 Sunnyburn Machine Works  
 167 Atkins Road • Airville, PA 17302  
**717-662-3018**

### Benefits

- Will let your employees know when they are to begin and stop working so they know what is expected of them
- Encourages job-focus over clock-watching
- Promotes teamwork with all employees starting and stopping at the same time

### Features

- 12V DC Powered (other voltage available)
- Internal battery backup saves time and setting approximately one month
- Low power usage - less than 1/2 amp
- Attaches to any standard 12 volt battery
- 8 Programmable set times (bell times) per day
- 8 different bell tones (bell sounds)
- Programmable bell ton lengths (3 seconds to 1 minute)
- Programmable volume control
- Up to 10 bells through 1 control box
- Simple to program
- Instruction included!

## Manufacturing

# ROW CROP CULTIVATORS



### Rotary Hoe Pro

- Control depth and angle of rotary hoe wheels.
- Effectively break crust within the row.
- Additional options available: tine weeders, finger weeders, double hoe



### Swinging Spider

- Save time and energy with our quick adjust concept.
- Optimize your equipment quickly and consistently switch from cutting away to throwing dirt into the row.
- Floating row shields available with additional options in development.



### TH FABRICATION

77 E Main Street, PO Box 212, El Paso, IL 61738  
 Call Jonathan Hostetler or Chris Kennel for more information at: 309-319-6165  
[www.th-fabrication.com](http://www.th-fabrication.com) | email: [jonathan@th-fabrication.com](mailto:jonathan@th-fabrication.com)



## NEED HELP WITH YOUR SPREADSHEET?

We can help build spreadsheets in Excel, OpenOffice, Libre Office, and Google Sheets.

Contact Stephen at (620) 888 7050 or [stephenjohn.aguilar@gmail.com](mailto:stephenjohn.aguilar@gmail.com)

## Tri State Grinding

RAYMOND DETWEILER

8718 Bundysburg Rd  
 Middlefield, Oh 44062

(440)272-5115



Wide Band

Grade Resaw

Narrow Band

Pallet Resaw





# DRIVE WITH BIO

Support American and local jobs. Purchase buggy harness made with BIO for your family.



SINCE 1977

**BIOTHANE** usa

BioThane Coated Webbing  
34655 Mills Road  
N. Ridgeville, OH 44039  
440-327-0485 [biothane.us/animal](http://biothane.us/animal)



**ORDER YOURS TODAY!**  
Visit [EZAnimalProducts.com](http://EZAnimalProducts.com)  
for demo videos!

*UltimateEz with Stainless Steel Bucket  
and Ez Power Pak*



"Buck has authorized me to give Free Shipping to all Milker orders for December"   
Wishing everyone a very Merry Christmas & Happy New Year.

**Put these on your "BUCKET" list!**

**Don't forget about our other products,  
The Udderly Ez Hand Milker and The Stableizer!**



**EZ Animal Products - Buck Wheeler**  
2524 Pascoli Pl, Lexington, KY 40509  
507-213-2126  
Toll Free: 800-287-4791

**Fisher Manufacturing**  
706 Red Hill Road  
Narvon, PA 17555  
717-768-0155

**MICHIANA Catalog Sales**  
12865-2 C.R. 30, Middlebury, IN 46540  
574-642-4768  
Toll Free: 844-477-3268

**BROOKSIDE HARNESS**  
Harley Helmuth  
N4227 Brook Road, Bonduel, WI 54107  
715 758 6186





# WATER STORM™

# The Gift for Those Who MEAN BUSINESS

**Shop a Local  
Water Storm  
Dealer:**

**A&J Power Equipment**  
Bird-In-Hand, PA  
717-295-1772

**Falcon Engine, LLC**  
Goshen, IN  
574-642-4353

**Keystone Supplies**  
Atlantic, PA  
814-724-9824

**Ridgeview Performance**  
Ravenden Springs, AR  
870-892-0073

**Seymour Farm Supply**  
Seymour, IA  
641-898-2248

**Valleyview Farm Store**  
Hopkinsville, KY  
507-932-9966

**Andrews Small Engine Repair**  
19 Nicklin Rd  
Jackson Center, PA

**Farmland Hardware**  
Bethany, MO  
660-425-2004

**North Haven Ag Center**  
Danville, PA  
270-275-2890

**Schlabach Engine**  
Apple Creek, OH  
330-698-0229

**Stoll Brothers**  
Odon, IN  
812-636-5053

**Wickey Buggy Works**  
2606 W 110 S  
Geneva, IN

**Blue Point Small Engine**  
Rinard, IL  
618-673-2033

**Hawpatch Engine Repair**  
LaGrange, IN  
260-463-4328

**Quality Engine Service**  
Newaygo, MI  
231-924-6707

**Schmidt Engine**  
Carlisle, KY  
859-473-1959

**Stoltzfus Plumbing**  
1355 Mt Vernon  
Hopkinsville, KY

**Willow Springs Harness Shop**  
16041 King Rd  
Mineral Point, WI



*Residential Washer*

**This Season...  
CLEAN IT LIKE YOU  
MEAN IT**

*Commercial Washer*

**Miller  
POWER<sup>LLC</sup>**

Miller Power, LLC | 260-768-7002 | 6735 W 100 S | Topeka, IN 46571

# Set your sales on fire

All it takes is a spark.  
A trusted 30 year family business,  
providing exceptional creative and  
marketing services for growth.

**We have you covered:**

Marketing plans, logo & branding programs,  
advertising, direct mail and targeted list purchase,  
catalogues, product brochures, web site design,  
social media, trade show booth design, trucks & signage,  
PR & consulting.  
Our goal is your business growth.

Call to learn more +  
for a free consultation

**verve** | MARKETING  
& DESIGN™

610-399-1003

VerveMarketingAndDesign.com

# Country Variety Show

Sponsored by GVS Distributors

**Wholesale Customers Only**

- Fabric • Notions • Toys • Puzzles • Books • Cards • Decor
- Stationery • Stickers • Gift Items • Clothing • Housewares
- Footwear • Outerwear • Baby Care • Health Products

Millersburg, OH  
 Harvest Ridge Event Center  
 8880 OH-39, Millersburg, OH 44654  
 Tues. Jan. 11, 2022, 8 AM - 5 PM  
 Wed. Jan. 12, 2022, 8 AM - 12 Noon  
 Free meal for two

Product catalogs not available.

For more information, call (573) 378-2000 ext. 117.

**Woodworking** ★★☆☆

**Metalworking** ★★☆☆

**Sawmill** ★★☆☆

Friday & Saturday, January 14<sup>th</sup> & 15<sup>th</sup>

Free  
Coffee &  
Donuts

CAM  
Slideshow  
Friday  
6-30 PM



www.northeasttoolexpo.com  
 4860 Yautzy Rd Stanley, NY 14561

January 14<sup>th</sup>  
 12PM - 7:30PM  
 January 15<sup>th</sup>  
 8AM - 2PM  
 Auction @ 9AM



Check Out  
The latest  
Power Tools

Bid at  
The Auction

Enjoy  
Food, Fun  
& Fellowship

Win Prizes  
& Giveaways

Info: 585-526-6528, 607-243-7167 Auction info: 585-526-5964

**Limited Booth Space Available** ★★☆☆

**Consignments Wanted**



**DIEHL MACHINES**  
 A DIVISION OF MEREEN-JOHNSON

America's best straight-line rip saw with a glue line cut second to none!

Industries served: Furniture, Flooring, Cabinetry, Doors, Windows, Mouldings, Custom Millwork, Rough Mill



**For Sales, Parts or Service call 260-563-2102 / www.DIEHLMACHINES.com**



# Let a Grillo help you provide.



LOG SPLITTER



SNOW BLOWER



brush



finish mower



rotary plow



snow plow



rotary tiller



cultivator

**CONTACT YOUR NEAREST DEALER**

**Premier Lawn & Garden** 5484 CR 59 Millersburg, OH 44654 phone: 330-674-1376

**Gingerich Repair** 2890 E 1275 S Kokomo, IN 46901 phone: 765-395 7816

*Work and Play...Roll a valley Road Speeder Today!*

CALL FOR YOUR NEAREST DEALER

Miniature Horse or Pony Wagons

**Poly Dump Wagons**  
Built super strong with heavy duty poly tubs

**Aluminum Dump Wagons** also available

I'm a small horse, but this wagon pulls so easily!



**Steel Bed Wagons**

**Trike & Trailer**

5 colors available



Custom sizes available



More models available



Includes brakes and super strong gear with 3/4 axle

Wheels have 3/4 axle

**Aluminum Bed**



Poly beds available in all models

Call for prices and brochure  
New Dealers Welcome

We stock a full line of **Good Quality** Pneumatic, Flat Free & Hard Rubber Wheels. Custom sizes available. Over 25 different styles and sizes in stock.



We stock a full line of **Wheel Accessories:** Straight Brackets, Swivel Casters, Inner Tubes, Bearings, Hubcaps

**GREAT PRICES FOR LARGE VOLUME**

**valley Road Woodworks LLC**  
1278 Georgetown Road • Quarryville, PA 17566  
717-786-6875

Harvest more business by increasing your advertising coverage...

# PCB EXTRA



... ask about advertising in the PCBExtra.  
Call 717-362-1118

# You are Helping Make a Difference!

**Christmas  
Behind  
Bars**  
OUTREACH  
MINISTRIES



## How to donate:

**Online:** [ChristmasBehindBars.org/donate](http://ChristmasBehindBars.org/donate)

**By Credit Card:** Call 260-827-8835

**By Mail:** Christmas Behind Bars, PO Box 474, Bluffton, IN 46714

Photo: Friends of this ministry prepare gift packages for delivery to prisoners.

Recently, we received a phone call from a mother who wanted to volunteer for this ministry. Curious, we asked her why, and she told us that her son was in a county jail in 2019 facing double murder charges. **While there, he received a gift package from Christmas Behind Bars.** He began reading the devotional materials and Bible, **and he gave his life to Christ.** He spent 2 years in the county jail before being sentenced to 60 years for his crimes. He is serving his time in an Indiana maximum security prison psych ward. **He has continued his walk with Christ, and he told his mother that every time he gets a new cell-mate, God sends someone who does not know the Lord, and he has the opportunity to share the gospel with him.** His mother said that he is the happiest he has ever been in life.

We don't know who sponsored his gift package in that small county jail in 2019, but their sponsorship has made a tremendous difference in this young man's life, and possibly the lives of many other inmates who come into contact with him.

**Your sponsorship makes all the difference. Without you, this ministry couldn't go and share the Gospel with prisoners. How many lives are you willing to touch? Please donate today so we can continue to deliver gift packages and Bibles to prisoners all throughout the year.**

## Timberlane Finish Solutions is Proud to Now Be a Distributor of Anest Iwata Spray Systems

Your passion fuels our innovation and creativity for developing coating solutions and technologies that drive our industries forward.

**ANEST  
IWATA**



**iCon<sup>®</sup>  
XE**  
30:1 PUMP

Versatile 30:1 ratio moves fluid at high pressures while using low inlet pressure

Anti-Blocking Changeover System prevents stalling for less down time

Easy disassembly for quick cleaning

Compact size in both wall mount and cart mount versions



**TIMBERLANE**  
FINISH SOLUTIONS

🌐 [www.tlfinish.com](http://www.tlfinish.com)

@ [customerservice@tlfinish.com](mailto:customerservice@tlfinish.com)

☎ 419-465-8255



# Make your holidays bright!

We offer a variety of decorative lighting solutions to brighten up any space in your home. They are all battery-powered and can be easily installed.



**Barn Beam Chandelier**

**\$389.95**

Price includes bulbs



**Pendant Light**

**\$69.95**



**Floor Lamp**

**\$249.95**

**Wall Sconce Light**

**\$79.95**



**Powered by the battery of your choice:**

Makita • DeWalt • Milwaukee

**CREATIVE**  
**PowerCell-utions**

# The Beginnings of a Humble Farm Implement: THE GROUND-DRIVEN MANURE SPREADER

CHRISTOPHER PETROVICH

The manure spreader is the farm tool that I've made extensive use of since endeavoring to become a farmer. Believe it or not, the manure spreader is the implement that neighbors most often gossip about. "What type of manure is that? Where did he get it? And where is he going with it?" they chatter. Even grannies are interested in the topic. That's because I'm only the fourth person in the village to own a manure spreader, and I spread roughly 520 tons of sheep, pig, and cow manure last year, probably a record for the village. Who invented this humble but very practical implement? Were they motivated to save time and energy on the farm, or was there an alternative reason? First, we will answer the question of when humans recognized the agricultural value of animal excrement.



An early manure spreader, abandoned in a field, growing old.  
Image Source: Charles Bush

## Figuring out the agricultural benefits of manure in global perspective

According to agronomists at the University of Nebraska-Lincoln, farmers have recognized the value of animal manure for thousands of years. This claim is based upon research conducted by a team led by Amy Bogaard, an archaeobotanist at the University of Oxford. The team gathered samples of ancient cereals such as wheat and barley, as well as pulses including peas and lentils, from thirteen early European sites that they date over 4400 years ago. The sample size included more than 2500 seeds from eleven sites spread roughly on a line from southeast to northwest Europe. These samples were analyzed to determine whether N-15— a rare nitrogen isotope that exists in much higher quantities in soil that is regularly treated with significant amounts of animal manure—was present in elevated levels. The results came back positive.

For example, at the Neolithic site in Slatina, Bulgaria, N-15 isotopes were only minimally present in lentil and grass pea harvests while N-15 isotopes were discovered in high quantities in einkorn and emmer harvests. Since lentils and grass peas fix nitrogen from the environment, it seems likely that ancient farmers figured out that animal manure is best utilized for cereal crops. [Amy Bogaard et al, "Crop manuring and intensive land management by Europe's first farmers," *Proc Natl Acad Sci U S A* 110 (31): 12589-12594]

Egyptologists believe that ancient Egyptians practiced manuring. They surmise that farmers noticed that grass was greener next to piles of cow dung, and this prompted them to spread manure on their fields. After some time, it is possible that the Egyptian farmers also noticed that when they burnt their weeds at the end of the season, the



combined result of the manure and ashes led to greater plant growth the following year. Eventually, farmers who cultivated land along the seashore began adding ground seashells to the mix, adding calcium to the soil, further improving growing conditions. This resulted in gradually improved harvests in Egypt, except when drought or pestilence struck.

Scholars of Middle Eastern history note that although dry animal dung is used as a heating product to the present day, Yemenis have known about the agricultural value of animal dung for centuries. For example, 13<sup>th</sup>-century Yemeni mathematician, astronomer, and agriculturalist (and also, for twenty-one months, ruler of Yemen) Al-Malik Al-Ashraf wrote extensively on this topic in his book titled *Milh al-Malâha*. He notes that pig manure burns plants, referring to it as hot and dense. Following the Greek and Latin traditions, Arab farmers considered duck and goose dung equally unsuitable in the form of fresh manure. And chicken manure was included in this category. But their knowledge didn't end there. Drawing on Ibn Bassal—an 11<sup>th</sup>-century Arab Andalusian Arab botanist and agronomist in Toledo and Seville (today Spain)—al-Malik al-Afdal wrote extensively about composted manure. This included discussions of the benefits of applying animal manure mixed with straw, as well as the addition of fresh and dried vegetation, household waste, and ashes. Ibn Bassal had long recognized that the application of this type of manure helped soften coarse soil. He attributed it to the “stickiness” of the composted manure. He recommended a minimum of one year of composting, otherwise he believed that harmful insects would appear on the plants grown where the manure was spread.

As Steven M. Nolt observes in *A History of the Amish*, the outsider status of the Amish encouraged European Amish families to innovate agriculturally. Limited means of expanding tillable acreage forced them to find ways to increase yields on fixed spaces. This meant clearing forested land, draining swamps, and fertilizing tilled land with animal manure and gypsum. They had more manure to spread because they were forbidden from purchasing additional land, and therefore invested their funds in livestock. Although the value of animal manure was clearly known in preceding centuries in different parts of the globe, the Amish improved the soil so much that they became known as model farmers, revealed by the appearance of a new farming almanac in France titled *L'Anabaptiste ou Le Cultivateur Par Experience* (*The Anabaptist,*

*or The Experienced Farmer*) in 1812, Amishman Jacques Klopfenstein appearing on its front cover page. When would this widespread knowledge of the value of animal excrement for agriculture lead to a more practical means of spreading it than by pitchfork and wagon?

### **Inventing the First Manure Spreader**

Spreader innovation began in the 1850s. JK Holland made what was probably the first attempt, followed by JH Stevens in 1865. The pressure for innovation was connected with the fact that the continued usage of horsepower in rapidly growing urban spaces was resulting in serious manure problems. For example, by the late 1800s horses were producing enough manure in New York City to fill 250 modern dump trucks per day. There was no simple way to move that manure to the spaces where it would be beneficial. So, the basic, ground-driven manure spreaders that we use today were actually invented to solve a dilemma caused by urbanization.

The first successful manure spreader was designed by Joseph Kemp in 1875. He invented a horse-drawn, ground-driven unit by incorporating the best ideas he learned from Holland and Stevens, and mixing it with some of his own ingenuity. It all started quite humbly with an ox cart he modified for personal use. When a

*Manure Spreader - Continued on Page 246*



Spreading manure in Shelby County, Iowa in 1941.

Image Source: Wikimedia Commons

Kemp spreader advertisement for an improved model in 1895.

Image Source: Gleanings in Bee Culture 1895



Kemp marketing his manure spreader, presumably to city folk.

Image Source: Boston Public Library

*Manure Spreader - Continued from Page 245*

neighbor noticed the amount of time and effort his innovation saved in getting manure to the fields, the neighbor encouraged Kemp to replicate it for others. Although we might expect that the spreader functioned much as today, Kemp's first manure spreader only pushed manure off the back of the unit. However, this was a very significant first step in manure spreader technology because it eliminated the manual labor required to physically push manure off a wagon.

Soon after inventing the spreader, Kemp moved from Quebec, Canada, to New York. He turned his fancy ox-cart into a business concept by patenting his design, including movable slats in the floor and a rotating drum at the rear. In 1877, Kemp partnered with William Burpee to form the Kemp & Burpee Manufacturing Company. Their partnership was fruitful until the death of Burpee. For most of this time, they had a contract with Richardson Manufacturing Company in which they were paid a \$5 royalty for each wagon sold.

In 1900, they began manufacturing their manure spreaders in-house, in Syracuse, New York. After a fire destroyed the factory on April 1, 1900, the company erected a new building in Newark Valley. By July, they were shipping spreaders



across the United States, and advertising these units for export. Because of significant demand from the western states, they built a second factory in 1903, in Waterloo, Iowa. Three years later, International Harvester bought them out.

### **The New Idea Manure Spreader**

The New Idea Manure Spreader brought the next stage in spreader technology. What was so new about the New Idea Manure Spreader? The addition of beaters. Joseph Oppenheim came up with the idea while watching boys play ball with a slat. Although the first manure spreaders naturally broke up most large clumps while pushing manure off the back of the unit, Oppenheim's design broke up finer clumps and tossed the manure rather than simply pushing it off.

The second benefit of Oppenheim's design was the width that his unit spread the manure. This so-called "widespreading" manure spreader not only reduced the number of passes that were required, it also eliminated the need of a spiked toothed harrow to further distribute the manure after spreading because the earliest designs deposited manure thicker than soil is capable of handling, burning the next year's crop.

Oppenheim began production in Maria Stein, Ohio, in 1899, in a small shop with the help of one part-time designer and two boys—Joseph's son BC and his friend Henry Synck. They built six manure spreaders the first year by retrofitting farm wagons. He sold these units to local farmers who called it "Oppenheim's New Idea." That name



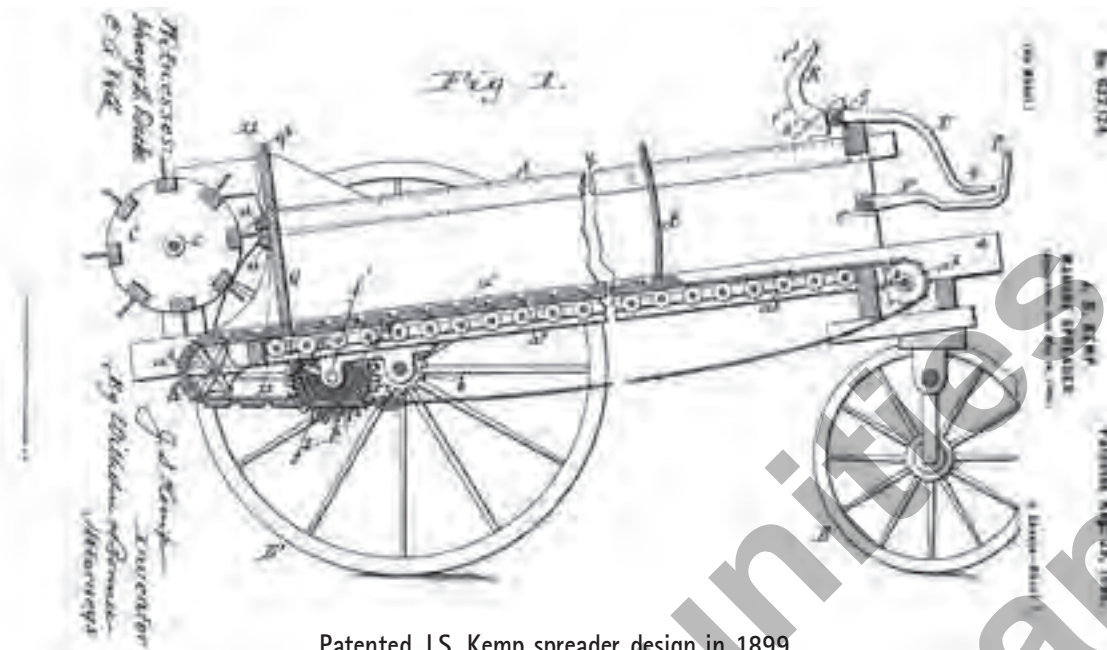

Patented J.S. Kemp spreader design in 1899.  
Image Source: Washington, D.C. Patent Office

stuck ever since. Although Joseph died of typhoid fever in 1901, his widow and the boys continued Joseph's endeavor. They formed the New Idea Spreader Company in 1904 and added an additional factory in Coldwater, Ohio in 1907. The benefit of the new location was improved railroad access. A Canadian division was added in 1915, as additional farm implements supplemented their original product line. What most people don't know about Joseph is the fact that he was also a schoolteacher, and that his pupils frequently left

school early because of the need to help spread manure on family farms, among other tasks. His invention was motivated by his desire to see his students stay until the end of the school day each day.

### Conclusion

Although much could be added to the history of the manure spreader in the following century, the main features of this humble but practical farm implement took shape in the half century starting with Joseph Kemp's invention of the first manure spreader in 1875. Why wasn't this practical implement invented much earlier? Apparently, there wasn't a perceived need. As the popular saying goes: "Necessity is the mother of innovation." In this case, it was the necessity of cleaning manure from urban streets, of reducing the amount of labor required to spread manure in fields, and finding a way to minimize the fieldwork that was keeping pupils from attending class until the end of each school day. That's not the entire story of the manure spreader. But it opens up the complex interaction between God's creation, human innovation, personal and social understandings of "needs" and "wants," urbanization, and industrialization. These topics are as relevant today as they were in 1875.



A refurbished New Idea manure spreader.  
Image Source: Roger Cordes

END

# LEGACY<sup>®</sup> Lubricants



**Pre-Season STOCK UP SALE!**  
Order what you want, when you want  
Color coded product lines for assistance with inventory.  
Order in Multiples - 12 quarts,  
4-1 gallon jugs,  
2-2.5 gallon jugs.  
**No Pallet Quantity Restrictions!**

**MADE IN USA** **LEGACY<sup>®</sup> 330 Gallon Totes** **FREE Shipping on \$500 orders**

Available in 55 Gallon and 330 Gallon Containers  
AW ISO 46 Hydraulic Oil  
Ask about pricing on quarts gallons, 2.5 gallons and 5 gallons.  
10W 30 and SAE 30 also available

15W40 Heavy Duty Diesel Engine Oil  
Meets CK-4 specification  
ISO 68 Tractor Transmission & Hydraulic Fluid  
Original Legacy with Wet Brake Additive & Rust Corrosion Protection

Totes are 330 gallon Intermediate Bulk Solutions for dealer service shops or larger farm operations.

**Twin Pine Equipment**  
"Quality Used Equipment"

1511 Produce Rd., Port Trevorton, PA 17864  
Phone: 570-600-8014 • Fax: 570-374-0206

## Smokey's Pre-Orbital Deer Lure

The only Pure Patented PRE-ORBITAL GLAND LURES in the World (Patent # US 9,980,492 82)

# Smokey's Deer Lures

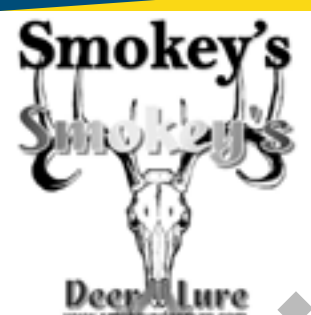

**Come see us at the MT. HOPE SHOW**

Wicked Wick Compound For Hanging Ropes or Licking Branches Trapping Lures and Bait

Deer Lure  
www.smokeysdeerlure.com  
It's the only one that really works!  
"From the Hills of West Virginia"

Write Smokey for a free brochure at:  
**Smokey's Deer Lures**  
Turkey, Deer, and Coyote Calls  
Call: 304-564-4087

242 Webster Lane  
New Cumberland, WV 26047

## Atlases • Maps • Globes

**Delorme Atlas and Gazetteers** Available for all 50 states.  
Detailed, large-format maps containing topographic and street map atlases with unbeatable detail, for the utmost in trip planning and back country roads.  
Please note what state(s) you would like.

AL, GA, HI, IL, LA, NE, NJ.....	\$19.95
AR, AZ, CA, CO, FL, IA, ID, IN, KS, KY, MA, MD/DE, ME, MI, MN, MO, MS, MT, NC, ND, NH/VT, NM, NV, NY, OH, OK, OR, PA, SC, SD, TN, TX, UT, CT/RI, VA, WA, WI, WV, WY.....	\$24.95
AK.....	\$26.95

**Miscellaneous Atlases**

North American Road Atlas, all US states - Canada - Mexico.....	\$15.99
Compact World Atlas, shows major highways, elevation & provinces.....	\$15.00
Childrens World Atlas, maps with 100's of photos & descriptions.....	\$17.99

**Classroom Spring Roller Wall Maps**

Large scale laminated state wall map 70"W x 42"H.....	\$185.00
U.S. Political wall map on spring roller 64"W x 54"H.....	\$169.00
World Political wall map on spring roller 64"W x 54"H.....	\$169.00
Above U.S. and World maps mounted together on one roller.....	\$249.00

**Rolled Wall Maps** Without spring roller (make your own or mount flat)

U.S. Political laminated rolled wall map 48"W x 36"H.....	\$16.99
World Political laminated rolled wall map 48"W x 36"H.....	\$16.99

**Globes** Blue ocean - raised relief.

Explorer 12" Globe, most popular, gold colored metal base.....	\$56.20
Traveler 12" Globe, lightweight, plastic base.....	\$50.20

Prices subject to change without notice.  
Flat shipping Rate! \$3.95 per order any quantity  
To place an order please send a check for the amount shown, NY residents add 8% sales tax.  
Cleon M. Martin | 2095 Ellis Rd, Dundee NY 14837 | 607-243-7466

## Jr's Clock Shop

**Your #1 Clock Supply House**  
**Specializing in Windup Clocks**

Jr's Clock Shop is dedicated to producing the *Finest Quality, Handcrafted Clocks* That can stay in your family for generations.  
Your Clock Comes with a 3 YEAR Warranty & 100% SATISFACTION GUARANTEED

- Grandfather Clocks
- Wall Clocks
- Shelf Clocks
- Mantle Clocks
- Clock Shelves
- Custom Clocks
- Clock Kits
- Clock Parts

GRF-09

PW-38

MC-05

**5% Discount from Now Until Dec 15th**  
if you mention this ad when ordering.  
Discounts do not include economy clocks.

Call for a FREE Catalog!  
1381 Mt. Vernon Church Rd.  
Hopkinsville, KY 42240  
270-475-4222 (8-10AM CT)

It's true, Christmas can feel like a lot of work, particularly for mothers. But when you look back on all the Christmases in your life, you'll find you've created family traditions and lasting memories. Those memories, good and bad, are really what help to keep a family together over the long haul.

~Caroline Kennedy

## CEDAR RIDGE LOG HOME SUPPLY

**More than 10 profiles in Log Siding!**

Plus Rustic Channel and Cedar Bevel Siding.

15 choices in Tongue and Groove Interior Knotty Pine and Cedar.  
NEW - Rustic Barn Wood Interior.

Ask about our Prefinished Options!

**DEALERS WANTED**

Joseph Miller  
14467 Beechnut Street, Ethel, MO 63539

phone: 660-486-3216  
fax: 660-486-3219







# The Better Choice

efficient batteries • dependable charge

## Batteries



### ECONOMY

No volt meter • Quick connect cable



### PREMIUM

USB • Digital Meters • Quick Connect Cable



### SOLAR BATTERY PACK 12V • 24V • 48V

Quick Connect Cables • Digital Meter

## Accessories



### DC CHARGER

5 amp • 10 amp • 20 amp

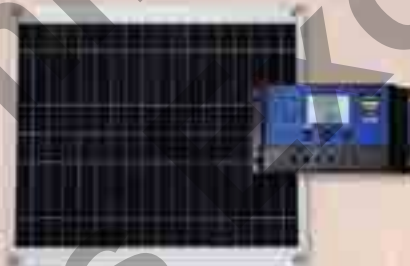

### BUGGY SOLAR KITS



### REPLACEMENT TOOL BATTERIES

6 AH • 9 AH



### SOLAR CONTROLLER



### INVERTER

12V • 24V • 48V

Call 1-800-315-2296 for your closest dealer, pricing or brochures.

## SUPPLIERS

- Mountain View Craft – La Jara, CO
- Kings Tool – Dover, DE
- Byler Cabinet Shop – Marion, KY
- Midwest Power Tool – Oak Grove, KY
- Byler Tool – Stanford, KY
- Cub Run Engine & Solar – Mumfordsville, KY
- Byler Country Store – Seymour, IA
- G-C Buggy Shop – Bloomfield, IA
- Stringtown Buggy – Kalona, IA
- DA Footwear – Berne, IN
- Martin's Buggy Shop – Nappanee, IN
- Wayne County Sales – Greens Fork, IN
- Turkey Run – Goshen, IN
- Rising Sun Supply – Rising Sun, MD
- Levi A. Graber – Candem, MI
- Courty Line Hardware – Holton, MI
- Walnut Acres Buggy Shop – Homer, MI

- Green Valley Harness – Centerville, MI
- Borntrager Shop – Jamesport, MO
- Mass Discount Grocery – Harwood, MO
- Hillside Supply – Jamesport, MO
- D & E Repair – Princeton, MO 64573
- Antelope Coach – Orchard, NE
- Bylers Solar – Clymer, NY
- Yoder's Farm & General – Burke, NY
- Brubaker General Repair – Brainbridge, OH
- Bylers Feed and Hardware – Middlefield, OH
- Keim Machine – Hillsboro, OH
- Hershberger Horseshoeing Supplies – Burton, OH
- Troyers – Albany, OH
- HL Sales – Fredricksburg, OH
- Premier Lawn – Millersburg, OH
- Countryside Farm & Home – Chouteau, OK
- Blue Mountain Small Engine Repair – Newburg, PA
- Hidden View Enterprises – Port Trevorton, PA

- Alco Metals – Spartanburg, PA
- Oregon Water – Leola, PA
- JK Solar – Watsonstown, PA
- Sand Ridge Carriage – Mill Hall, PA
- Mowersville Coach – Shippensburg, PA
- Nickel Mine Coach – Paradise, PA
- Shady Lane Hardware – Spring Glen, PA
- Riehl Outdoor Furnace – Honey Brook, PA
- Sweetwater Coach – Honey Brook, PA
- Schauback Carriage – Pottsville, PA
- Bird in Hand Farm Supply – Bird in Hand, PA
- Willow Valley Hardware – New Holland, PA
- AR Coach Works – Witham, WI
- Borntrager Construction – Manswa, WI
- Coloma Lumber & Hardware – Coloma, WI
- Pug Haven Farms LLC – Spring Mills, PA

## DISTRIBUTORS

- Seymour Solar – Southern Iowa
- Rise & Shine Bakery – Arcola, IL
- MW Repair – Northern Indiana
- Knepp Battery – Southern Indiana
- Pleasant Valley Battery – Northern Ohio
- Scenic View Engine LLC – Holmes County, OH



RhinoVoltz.com  
 sales@rhinovoltz.com  
 1559 Georgetown Road,  
 Christiansburg, PA 17509



# ADC

Arthur Distributor Co. LLC  
 PREMIER WOODWORKING SUPPLIES  
 283 E SR 133 - ARTHUR, IL 61911  
 Ph: 217-543-2166 Fax: 217-543-2167  
 Email: arthurdesignco@gmail.com

- Patented rail system mounts on wall before the vanity. Vanity brackets hook onto the rail for a simple, sturdy install. Vanity weight is supported by rail while it is pushed against the wall and secured.
- Available in kits for vanities 15-84" wide. Kits include all the components necessary to hang a floating vanity.
- 500lb weight rating for smaller systems. 1000lb weight rating for larger systems.

SKU	Min Vanity Overall Width	Max Vanity Overall Width
FW-100	15"	27"
FW-110	20"	32"
FW-140	28"	40"
FW-170	42"	50"
FW-200	56"	64"

## DG Electra Cell LLC

### 180° SILVER SHINE LANTERNS

**\$124**

**50% More Runtime!**

Wow! This light speaks for itself. If you want serious lighting, look no further. Silver Shine Lanterns are capable of handling bulbs up to 30 Watts with no shadow on the bottom side!

*While supplies last  
Prices subject to change*

**Call Dennis**  
**260-761-1065**  
 3-5w Weekdays  
 8308 N 300 W | Ligonier, IN 46737

### Wireless Speed-O-Meter

- Rechargeable
- USB port / Cable
- Speed - mph
- Dist. (M, Max)
- Avg. 000

**\$65**

**100's in Stock Wholesale Retail**

### Safety Lights

- 1 Cord
- Rechargeable with Flash
- Follows
- Good For
- 180° view
- Wire
- Cord

**\$25**

**Light Weight**

**Rechargeable**

**Multi-Brightness**

**USB Port / Cable**

### Hawker Headlite

**\$28**

## RC GOLD 4X

**\*10% off during December**

**A concentrated supplement providing fat soluble vitamins, probiotics, enzymes and trace minerals that supports a healthy animal during times of stress and reproduction**

75th Anniversary

SINCE 1946

Better Naturally!

- Provides abundant fat-soluble vitamins which are particularly important during times of stress, including reproduction, when the body's demand is higher**
- Promotes better feed efficiency, improve milk production, and enhances daily gain by providing beneficial Direct-Fed Microbials (probiotics)**
- Allows farmers to feed a wider range of small grains efficiently by including special digestive enzymes**

**Contact your local Fertrell Representative or Fertrell's main office at 800-347-1566 \*restrictions apply**

# ASSISTING

with PRODUCT SHORTAGES

WHOLESALE | CUSTOM IMPORTING

*MayKo Products has connections with suppliers over seas. Let us assist you with **product shortages** you are dealing with currently.*

*Contact Mose for more details.*

**P. 866.432.2385**  
**F. 330.556.4542**  
 PO Box 584  
 Sugarcreek OH 44681  
 mose@maykoproducts.com

**MAYKO PRODUCTS LLC**  
 UNIQUE PRODUCTS. GREAT MARGINS.  
*Limitations apply. Contact us for details.*



For all your "COOL" needs

# MUSSER

## REFRIGERATION

East Earl, Pennsylvania  
717-445-6991

**WE SHIP**



12/24Vdc Freezer



12Vdc Control Panel



Milk Tank Parts



Bulk Milk Tank Agitators



Stainless Steel Icebox

Since 1997

**We handle many parts for Beltdrive/12Vdc Refrigeration Systems  
We have many used bulk milk tanks available!**

# 100% Acrylic Paint



**MADISON**  
PREMIUM PAINT

- Excellent Touch-Up Capability
- Early Water Resistance - No Bubbling
- Self-Priming Technology
- Guaranteed Color Consistency
- Custom Colors Made
- No Hassle Spraying
- 15 Year Warranty on New Surfaces

## S & M Enterprises

Distributor for A&L Paint  
4164 Long Road, Hartville, MO 65667  
Serving west of the Mississippi in addition to Wisconsin, Illinois, Kentucky, Tennessee, Mississippi & Alabama

Phone: 417.349.1386 / Fax: 417.349.2372

# YOUR PARTNER FOR YOUR SUCCESS

Insurance - Risk Management  
Safety - Legal  
Leadership Development

For over 30 years, our agency has served the needs of businesses and individuals by providing a unique set of services that goes beyond just insurance.

Call us today to see how our approach can positively affect your bottom line

**717-625-3770**

3399 Jetstar Drive  
Lititz, PA 17543

www.robertson.insure



## Are **YOUR** Tables Rotting? Sagging? Warping? Hard To Clean?

**OUR Tables have Durable UV Protected Tops and Strong Fiberglass Frames!**

**No Rotting!  
No Sagging!  
No Warping!  
Easy To Clean!**

4 ft. x 12 ft. Table with 24" - 30" Legs

6 ft. x 3 Tier Display Rack with Hanging Basket Rail

Custom Sizes Available

**Durable Design**





**SUPERIOR GREENHOUSE TABLES**

451 Street Road • Oxford, PA 19363  
**(610) 998-1686**





**A Time to EAT...**  
 is the Garman Family's collection of over 850 recipes. We focused on simplifying and clarifying each recipe so that everyone can have a happy, successful cooking experience and an enjoyable *Time to Eat!*

7" x 8.5" • 438 pages  
 Full Color Divider Pages

\$21.98 each (PA residents add 6% tax)  
 shipping: \$5.00 for up to 2 cookbooks



*Welcome* to the  
 Flowers & Friends Series!

These 8x8 Hard Cover books each have 26 to 38 pages filled with beautiful Full Color Pictures. Read along as the children play and care for God's wonderful creation!

- #1 **Holly the Heifer**  
Calf's Life on the Farm
- #2 **Daffodil the Dutch Rabbit's**  
Surprise
- #3 **Poppy the Paint Pony**  
and **Cody's Prayer**
- #4 **Pansy the Special Puppy**  
and **Her Playmates**

\$11.98 each (PA residents add 6% tax)  
 shipping: \$5.00 for up to 8 books  
 Call for wholesale pricing!



**Taste of JOY...**  
 is the Weaver Family's collection of over 570 recipes. A beautiful Hard-Cover cookbook!

**NEW Cookbook!**  
 Hard Cover  
 7" x 8.5" • 368 pages  
 Full Color Divider Pages

\$23.98 each (PA residents add 6% tax)  
 shipping: \$5.00 for up to 2 books  
 Call for wholesale pricing!

**Oak Lane Books LLC**

2146 Oak Lane  
 Manheim PA 17545  
**717-664-7551**

Note:  
 We do not  
 have catalogs.

## Foot Bath Body Cleanse

This is the time of the year to detox.



Massaging Insoles

Bemer

## Massage Chair



Air Purifier



Artery Care

**Pharm-Aloe**  
 • Liquid  
 • Tablets  
 • Shampoo



Decompression Table

Distributor: EC Health Services  
 Eli Weaver • 1333 CR 168 • Dundee, OH 44624  
**330.893.0017**

**Clear View Optics**  
 Quality Optics @ Competitive Pricing  
 Spotting Scopes-Range Finders-Rifle Scopes-Binoculars

Volume Discounts

Call for a FREE Catalog

FREE SHIPPING

Perry Beechy • 19418 220th Avenue, Tustin, MI 49688 | 231-829-3266

## OUR SERVICES

**Rebuilding**

- pumps
- injectors
- turbos
- electronic injectors

**We Ship UPS Daily**

### DIESEL PICKUP DRIVE IN SERVICE

**DIESEL SYSTEMS Sales & Service LLC**  
 9669 Mountain Brook Road • St. Thomas, PA 17252  
**717.369.4343**  
 Over 50 Years Experience



# Thinking of Building a New Broiler, Layer, Breeder, or Turkey Barn?



**SKIOLDLANDMECO**

Complete Nest Systems  
Colonial Nest Systems • Feed Lines  
Fill Systems • Waterlines  
And So Much More!



Complete Ventilation Systems  
Fans • Coolcell Systems  
And So Much More!



**Big Dutchman.**

Complete Colonial Nest Systems  
Chain Feed Lines • Fill Systems • Feed Bins  
And So Much More!



ALL WORK IS  
COMPLETED BY  
OUR EMPLOYEES.  
NO SUB-  
CONTRACTORS.



**Advanced  
POULTRY SYSTEMS<sup>LLC</sup>**  
Innovative Poultry House Solutions

Quality Buildings & General Construction  
Designing • Excavation • Concrete Work  
Framing • Equipment Installation



**Advanced  
POULTRY SYSTEMS<sup>LLC</sup>**  
Innovative Poultry House Solutions

PHONE 717-474-2100  
E-MAIL [sales@advancedpoultry.net](mailto:sales@advancedpoultry.net)  
WEBSITE [skconstructiononline.com](http://skconstructiononline.com)

AUTHORIZED DEALER FOR  
Landmeco • J&D Manufacturing • Big Dutchman



Special  
Application  
Woodworking  
Machinery

**Associated Machinery Sales, LLC**  
2403 Industrial Drive Madison, WI 53713  
Phone: 608-221-2543 Fax: 608-221-2541

Ron's Cell: 608-575-7667  
Ron's Email: ronm@amstool.com • www.amstool.com



**SPECIAL APPLICATION WOODWORKING MACHINERY**

**AMS PRODUCT LIST**

**WHAT IS SECTION 179?**

Section 179 encourages business owners to invest in equipment or technology by allowing them to deduct a substantial amount of the asset's value the first year.

<b>Air Compressors - Sale</b>	Dust Collection	Panel Saws
Band Saws	Dust Pipe	Planers
Briquet Equipment	Edgebanders	Pocket Hole Machines
<b>Clamp Carriers - Sale</b>	<b>Edgesanders - Sale</b>	<b>Power Feeders - Sale</b>
CNC Routers	End Matchers	Radial Arm Saws
Conveyors	Felt	Ripsaws
Distressing Wheels	<b>Financing - Sale</b>	Sanding Sponges
Door Equipment	Gang Ripsaws	<b>Sandpaper - Sale</b>
Down Draft Tables	Glue Line Ripsaws	Saw Blades
Dovetail Machines	Graphite	<b>Shapers - Sale</b>
<b>Drills (Line) - Sale</b>	Jointers	<b>Table Saws - Sale</b>
<b>Drill Bits - Sale</b>	<b>Measuring Systems - Sale</b>	Tenoners
<b>Drill Presses - Sale</b>	Moulders	Tooling
Dust Bags	Overarm Routers	Wide Belt Sanders

**— HAVE A MACHINE NEED? CALL ME. —**  
**SELLING WOODWORKING MACHINERY FOR 36 YEARS**



**Cycle Works**  
*of Kentucky*



3572 Whitehall Rd, Mackville, KY 40040 · Phone and Fax 859.375.5003

**LUMINA OLED  
1200 BOOST**

- 1200 Lumens
- 4 Light Levels Plus 6 Flash Modes
- 1 Year Warranty on Light
- Lifetime Warranty on Housing and Mounts
- The Lumina OLED removes the guess work related to battery life, allowing you to plan your next ride safely with complete confidence, day or night.



**NiteRider**

*Regular Price \$149.99*

**Metal Roofing Transport**

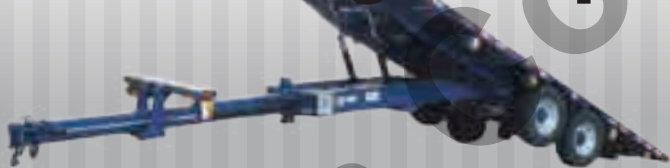

**STANDARD FEATURES:**

- 42" Wide Pop-up Rollers On Each Side
- Dexter Axles
- Monarch HD 12 Volt Pump
- Full LED Lights
- Safety Locks On Dump Cylinders
- Sand Blasted And Painted
- Starting Price \$24,550



**OPTIONS:**

- Trailer Remote Control
- Strobe Lights
- Front Tongue Extension (Up To 6ft.)
- Hydraulic Brakes
- Alcoa Aluminum Wheels
- Leasing Available



**Royal Metal Works 931.739.7777**

**1954 Hickory Valley Rd. Sparta, TN 38583**

**IDEAL**  
**Electronics**

**Low Bay LED Lighting**

*Whether freshening up lights or installing new, get enhanced light, durability and energy savings!*

Low Bay lights are ideal for under 14ft high ceiling applications...

- LED T8 Bulbs
- Open T8 Strip Fixtures
- Vaportight T8 Fixtures
- LED Dusk-to-Dawn Lights
- LED Outdoor Wall Lights
- LED Parking Lot Lights
- LED Highbay Lights
- LED Screw-In Bulbs
- LED Residential Lights
- Electrical Supplies



**Vaportight  
Fixture**

**4FT** Uses (2) Bulbs ~~\$72.50~~ \$65.25  
**8FT** Uses (4) Bulbs ~~\$104.95~~ \$94.46

We have replacement LED T8 Bulbs



**Open Strip  
Fixture**

**4FT** Uses (2) Bulbs ~~\$22.80~~ \$20.52  
**8FT** Uses (4) Bulbs ~~\$37.80~~ \$34.02

'Vaportight' and 'Open Strip' fixtures use (LED T8 bulbs).  
4ft - 18W - 2,340 Lumens ~~\$8.50~~ \$7.65 a bulb (Bulbs sold separately).

**Canopy Lights** **40W** 5,255 Lumens ~~\$59.95~~ \$53.96  
**70W** 8,744 Lumens ~~\$79.95~~ \$71.96



**Work Light**  
**100W** 15,000 Lumens  
~~\$124.95~~ \$112.46



Have questions on which light is best for your application?  
**717-354-9109**

Great for the shop, outdoor work, and camping.

P: 717-354-9109  
F: 717-354-9108

**10% Off Low Bay Lights - Ordered by 12/31/21**

95 N. Farmersville Rd. ■ Ephrata, PA 17522



1-800-638-4410



Grapek Bates.com

# GRAPEK BATES

## Most Trusted Name In The Industry



SurfPrep Sanding Equipment & Abrasives



RPB Z-Link Respirator Helmet & Welding Visor



Sames Kremlin Pump Systems



Binks Trophy Spray Guns



Paint Pocket Booth Filters



Sames Kremlin Cyclomix 2K

## CALL US FOR A FREE CATALOG

**YODERS True NATURE**  **MADE IN THE USA**

**CBD HEALTHY Coffee**  
Give It A Try!

**YODERS Nutrition**  **MADE IN THE USA**

**RICH IN OMEGA 3-6-9**

**Repro-Life**  
New Product

**HEMP PELLETS**  
for Equine Health Support  
MAY BENEFIT JOINTS, ANXIETY, OVERALL DIGESTION AND GUT HEALTH

**Horses Eat Hay, BUT Champions Eat Hemp**

**TO ENSURE QUALITY AND PURITY, WE GROW OUR OWN HEMP.**

RAYMOND YODER | 641-664-1391 | 21444 ICE AVE., BLOOMFIELD, IA 52537



How would you like to have a clothesline that allows you to stand in one spot to hang all your clothes, be able to adjust the height exactly where you want it, and never have to worry about loose lines again?

**Spinning Clothes Line**

*The Original*  
DEALER INQUIRES WELCOME



**10 YEAR WARRANTY**

**UP TO 2500 UNITS SOLD**

All in a great looking unit packed with powerful features, such as a ground socket, brakes system, line tighteners, durable powder coated finish and sealed bearing pivot.

We can now ship via UPS right to your door.



**We're changing the game . . .**

. . . with our new floating mower design that *pushes* the mower rather than pulling them like conventional gang mowers do. The end result gives you much more traction for better cutting through thick grass and less "hobbling" or uncut grass.

This unit also comes packed with other handy features. Such as, precise steering control, easy hitch shafts, jack with dolly wheel, adjustable seat and precise shaft height adjustment.



**EASY TURN LAWMOWER**

Call us for your closest dealer.

**6586 DECKERVILLE ROAD • DECKER, MI 48426**

**989.872.2391 between 8 AM-1 PM Mon.-Fri. or leave message after 1:00 @ 517.852.2115**

**DID YOU HAVE ENOUGH CHARGING POWER LAST WINTER?**

**Efficient Charging Station**

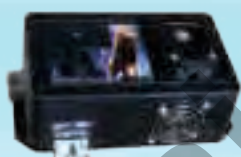

**LION**

+



**CUB**

=



**DEWALT Milwaukee**

**PRE-WIRED SOLAR KITS AVAILABLE**



Approximate Charging Time	½ hr	1hr	1½ hrs
# of 5 Amp Batteries	1	2	3

**FEATURES:**

- Use the LION for FAST charging off of any 12 volt DC power source
- Charge multiple batteries at once by connecting more CUBS to the LION
- Eliminates the inverter
- Can power as many CUBS as you need.
- Protects your 12 Volt Battery by Shutting down at 11.7 Volts
- 24 Volt and Solar-Direct options available
- USB charging port built in

**Uses up to 20% Less Energy than an inverter with AC Chargers**



**Circuits Alive!**

**Call John at 270-465-0821**

**fax: 270-465-0154**

**779 Rolling Acres, Campbellsville, KY 42718**



# Fully Pneumatic or Mechanical Pocket Hole Machine

**Foot Pedal  
Actuated!**

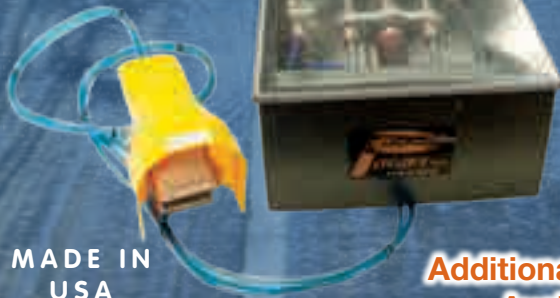

**Powerful  
Customized  
Motor**

**Fast  
Cycle  
Time**

**MADE IN  
USA**

**Additional Options  
Available**

**Dealer Inquires  
Welcome!**



**For Full  
Color  
Brochure**



10780 W 1100 N, Nappanee, IN 46550  
Ph.: (574) 646-2900 • Fax: (574) 646-2904



**Efficiently Power Your  
Washing Machine with  
a Flex-Shaft!**



**Motor Mounts  
Outside of a Wall  
to Drive Your  
Washing Machine!**

**No More Exhaust  
Fumes in the  
House!**



10780 W 1100 N, Nappanee, IN 46550  
Ph.: (574) 646-2900 • Fax: (574) 646-2904

**Viessmann,  
Sunrise &  
Navian Boilers**



Connect the indirect tank  
with the Boiler with just a  
temp sensor.



Shipping same  
or next-day!



**DOMESTIC WATER  
HEATING SYSTEMS & SUPPLIES**

DEALER INQUIRIES WELCOME!



11605 W 700 S  
Millersburg, IN 46543

Call Wayne Eash  
574.536.4447



**We have PEX  
Tubing & Fittings.**

# The Summit

## Mechanical Truss Press

No Electric | No Air | No Hydraulic  
2 Second Cycle Time  
Powered by  
13HP Gas Engine



### Optional

- Gas engine conversion to propane for cleaner exhaust for indoor use
- 10 times faster than Hydraulic Press

## "The Summit" Automatic Slab Wood Saw

### FEATURES:

- No Hydraulics
- No Air
- No Electric
- Keeps up with 10,000 plus feet a day sawmill
- Easily adjustable for the length of slab wood
- Saw arbor is below slab wood
- No more grabbing or kicking
- Torque limiter for safety
- Can be hooked up to line shaft or most any source of power
- Hold down arm to hold slab while being cut
- Clutch for in and out of gear.
- Standard in-feed conveyor is 18" w x 8' long



## Distributor for Brubacher Band Saw Filing Equipment

### WANT TO USE A CBN STONE?

Now offering Coolant Pump on New Band Saw equipment or add to your existing band saw sharpener

### BANDSAW BLADE SHARPENER

is very smooth running, powder coated and sealed bearings. All you need to do is hook up to your power source.



For more information or to place an order please write to:  
**Hershberger Manufacturing 7724 Banks Rd., Gainesville, NY 14066,**  
585-567-4341 Call 8:00 am to 8:30 am



## Ridge-L9

Easily mark angles on 9" o/c metal panels.

*Speed and Accuracy, one person can use.*

## Ridge-LSS

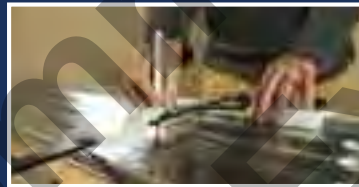

Easily marks angles on Standing Seam panels.

Adjustable to fit your panel.

Holds Carpenter pencil upright for accurate making.



## Ridge-R3:10



Accurately pre-punch holes in 9" o/c metal panels.

Safety and Speed-every time!

*Punches 6 panels at a time.*



TOUGH TRADE TOOLS  
info@countylineconcepts.com  
Call: 989-859-2168



Our hearts grow tender with childhood memories and love of kindred, and we are better throughout the year for having, in spirit, become a child again at Christmastime.

~Laura Ingalls Wilder

## Indoor Rebounders

Receive the benefits of rebounding exercise. 40 inch diameter frame with springs especially designed to produce a soft springy bounce to give the user the ultimate benefit. Has a very durable spring cover. Legs fold in for storage. All parts have a lifetime warranty. Stabilizing bar available. \$99.00

send check with order to  
**BUCKEYE BLANKET**

4285 TR 628, Millersburg, OH 44654

**\$340.00** each  
Includes Free Shipping

*Ohio residents add 7% Sales Tax.*



phone: 330-674-0879



# SOUTHERN KENTUCKY WOOD FURNACES

Eliminate the high heating costs!

- Sales
- Service



- Radiant Floor Heat
- Hitz-Halter Insulation



YOUR LOCAL BOILER DEALER  
**JASON SCHLABACH**  
**270.459.1840**

8263 Glasgow Rd Burkesville KY 42717

## B&W Bandaging Supplies At Discount Prices

Contact Us For A Free Catalog

Conforming Gauze, Tubular Bandages, Chair Pads, 4 X 4 Pads, Tape & More.



**Swiss Perfection LLC** Conforming Gauze  
100 S Huntington St. PH: 574-457-4457  
Syracuse, IN 46567

## Riverbend Fabrics & Variety

- Fabrics
- Sewing Notions
- Classic Comforts
- Clara Bedspreads
- Kitchenware
- Boxed Cards
- Burn Supplies
- Wedding Invitations
- Books
- Bibles
- Bible Covers
- Herbs
- Electric Bosch Mixers
- Steel Glo



Catalogs available for promotional (imprinted) products for your business or wedding event. (Must specify which catalog you are requesting, Business or Wedding.)

No retail catalogs available at this time  
**SPECIAL DEAL: FREE Shipping on personal and business checks, sales books, stampers, envelopes, note pads and much more! Napkins: printed or blank, also tableware available.**

Call to make special appointments:  
**231-832-1935** | fax: 231-832-1099  
758 170th Ave., Hersey, MI 49639  
Lavern and Rebecca Wickey

**Store Hours:**  
MONDAY.....8:30am - 5:00pm WEDNESDAY.....Closed FRIDAY.....8:30am - 5:00pm  
TUESDAY.....8:30am - 5:00pm THURSDAY.....8:30am - 5:00pm SATURDAY.....8:30am - 3:00pm

**SHIPPING AVAILABLE**

### CONTRACTOR:

Are you frustrated? Ready to GROW your business but not sure how? Ready to get ahead?

Or maybe you're thinking about STARTING your own business? Tired of working for a boss?

**There are 3 SIMPLE STEPS** you can take to eliminate the stress and frustration of starting or growing your business.

Listen to this recording and start getting clarity for YOUR business... dial **1-800-564-1996** recorded Contractor Information Line anytime.

© 2021



## FUSION BOLTS LLC

Crane Mat Bolts, Nuts & Washers

15801 Reifs Mills Rd Reedsville WI 54230  
(920) 455-9040  
sales@fusionus.net

- Made in USA!
- Forged Head
- 7/8" & 1" dia.
- Custom sizes available
- Full truck load discounts
- No order to large or to small



## Jeffrey Hunt, DC

### Highland Chiropractic

## LIGONIER, PA

724.238.2958  
www.sequencechiro.com

## GOT HORMONE PROBLEMS?

- Miscarriages
- Ovarian Cysts
- Hot Flashes
- Mood Swings
- Uterine Fibroids
- Infertility
- PMS
- Endometriosis
- Osteoporosis
- Cold Hands & Feet



**CALL FOR FREE INFORMATION**

Aim has been providing quality whole food nutritional products for over 38 years

- Constipation
- Poor Digestion
- Allergies
- Low Immune System
- Pain & Inflammation
- Low Energy

**ELDON & RACHEL KAUFMAN - 920-629-7852**  
5227 Maple Rock Rd, Reedsville, WI 54230

Aim Member

## A better and safer way to HEAT YOUR BUGGY!

Hard to keep your buggy warm? Burning holes in your pants or getting drowsy on fumes?

No more worries, get up to 6850 BTUs at the push of a button. "Magma Heat" will keep the air circulated and warm, with forced heat, from a directional vent on the floor. Heater bolts to the floor of your buggy and with a few simple hook-ups it is ready to use. Runs on mineral spirits or non gelling lamp oil and a 12 volt power supply.

- 6.4 watts on low
- 40 watts on high
- No open flame
- No fumes - vents to the outside
- Safer around kids
- Easy adjustable heat with the simple turn of a knob



**Blue Sky Components, LLC**  
260-768-8148 • 1555 South 700W • Topeka, IN 46571  
Call to place an order or for more information.



## CONSISTENT PERFORMANCE

### THAT SAVES YOU MONEY

With the **SNAPTABLE PRO® Hyper-lite**, you can count on delivering uniformly cut standing seam metal panels on all of your metal roof projects. Gain a competitive edge by reducing your metal preparation time by half and by reducing your overhead costs by **35%**.

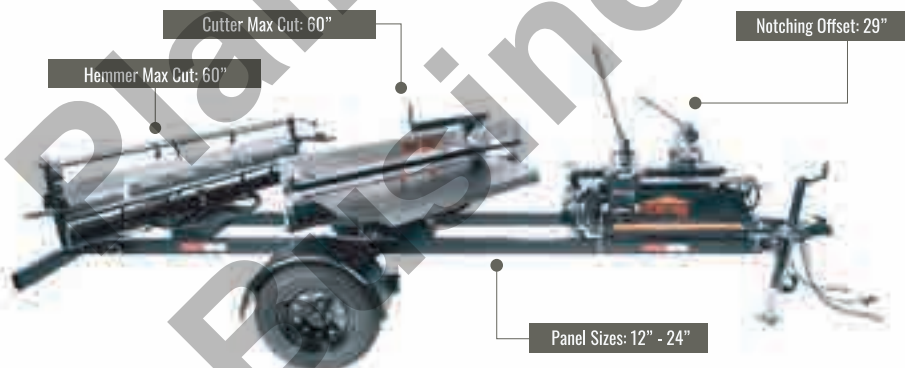

- ◇ Consistently notches, cuts and hems at your eaves, hips and valleys
- ◇ Create a tab to box off female leg of a SnapLock panel
- ◇ NO electricity needed
- ◇ Torsion bar single axel trailer with 2" ball



**CONTACT US TODAY TO ORDER YOUR SNAPTABLE PRO *Hyper-lite*!**



[sales@swensonshear.com](mailto:sales@swensonshear.com)



(877) 588-8748



[www.swensonshear.com](http://www.swensonshear.com)





# CUSTOM COIL & SHEET METAL HANDLING EQUIPMENT



## COIL UPENDER | \$5975

- Manufactured with built-in safety features.
- Needs no electricity or hydraulic system to run. Simply functions with a built-in hydraulic cylinder and needle valve.
- Easily controllable tilting to help minimize damaged coils.
- Smooth and easy operation.
- Easily movable with forklift or pallet jack.
- Built to last with industrial grade components.
- Compact design (4' x 6' floor space).

*"We would highly recommend the Four Star Upender. It's very affordable and takes all stress away when tipping coils. An amazing piece of equipment!"*  
- Clark Fork Metal

## SHEET RACKS WITH REMOVABLE TRAYS

- Remove individual trays with forklift for quick and easy mobility around the shop.



## COIL RACKS



## ROLLER TABLES



WE OFFER COMPETITIVE  
NATIONWIDE SHIPPING RATES

We manufacture the listed equipment as well as custom equipment built for your specific needs. Call for a FREE brochure.

151 W. Fork Combest Creek  
Plains, MT 59859

VM: (406) 880-0323

# FOUR STAR



# WELDING



## SHOWCASE EQUIPMENT LLC

# Own a Sawmill?

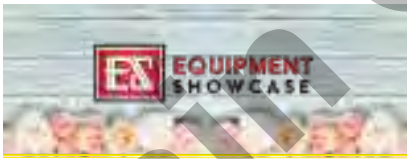

Call, write, or email  
John to receive our  
free equipment  
catalog

- Band Mills
- Circle Mills
- Band Resaws
- Edgers
- Debarkers
- Chippers/ Grinders
- Transfer decks/ Conveyors
- Blowers
- Power units
- Loaders/ Forklifts

**John Yoder (Sales):**  
260-250-3713  
Email: [jj@showcaseequipment.us](mailto:jj@showcaseequipment.us)

Address:  
11751 CR 12  
Middlebury, IN 46540



# HOW TO BUILD YOUR ANNUAL MARKETING BUDGET

“How much should we budget for marketing?” That’s a question that dozens of business owners have asked me. Your accountant may have told you 3% of revenue is a good number (or maybe he said 5% or 1.5% or some other number he thinks would work well. Or, he may use an average for your industry he found in a report).

I like my accountant, but I don’t depend on him for setting my marketing budget, and you don’t need to either. Accountants are often detailed-oriented, conservative thinkers with low-risk tolerance. Those characteristics make them good accountants but poor entrepreneurs.

Now you accountants, before you close your ears, please hear me out. We need you and your perspective. You may disagree with me, but that’s ok. You have a right to your viewpoint.

### **Cut costs or increase revenue?**

Business owners need to understand the role accountants should fill and not fill in servicing the business. Accounting, by nature, is historical. The numbers tell us what happened. They also tell us where we are today. The numbers show trends, but they don’t tell us what will happen tomorrow. Just because numbers are trending up or down doesn’t mean they will continue that way because business, like life, is dynamic.

When cash gets tight, most accountants and business owners look for cost-cutting measures. After all, Ben Franklin warned, “Beware of little expenses; a small leak will sink a great ship.” This is an essential step when money or resources are being wasted.

However, cost-cutting has its limits. I clearly remember the paradigm shift I experienced when my business partner and mentor, Clair High told me

for the first time, “You can’t save your way to success.”

Why do we focus on cutting costs when there is infinitely more potential to solve cash and profit problems by increasing revenue? Cost-cutting is appealing because the results are usually quick, quantifiable, and tangible. Plugging leaking holes can indeed result in long-term savings, accruing substantial amounts over time.

But when cash is tight (and when it’s not), you should look for ways to increase your revenue. Like cost-cutting, this also can produce substantial amounts of profit in the long term. However, increasing revenue has the potential for more profit than the cost-cutting method. A lot more.

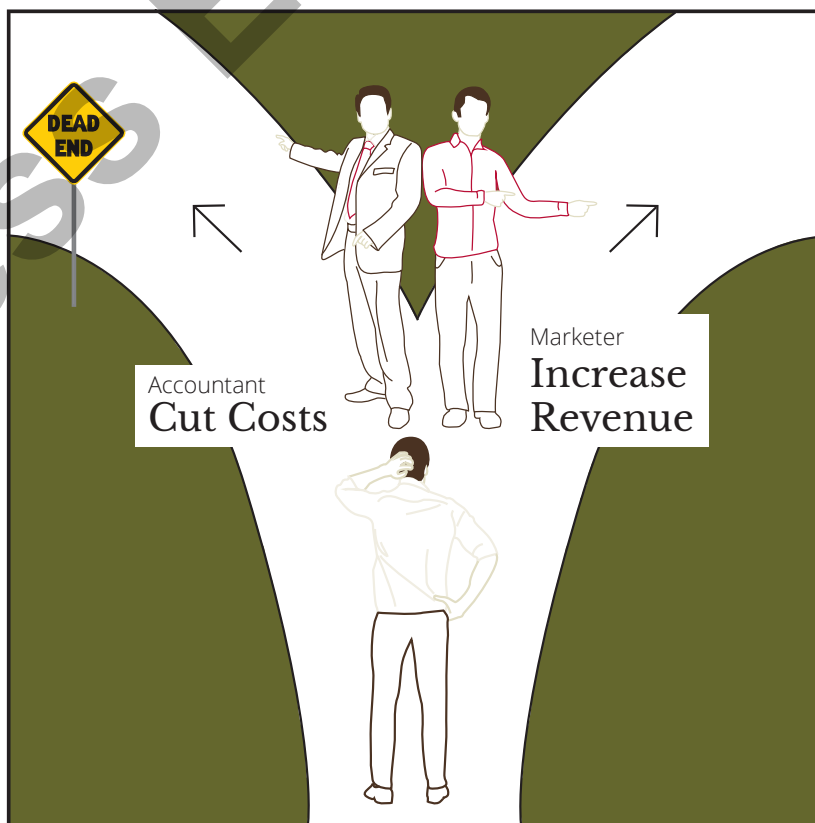



### **How much should I spend on marketing?**

Marketing is the way to find those new revenue dollars. You may or may not need to invest a lot of money. When cash is tight, it is critically important to look for ways to increase sales without investing many dollars.

There are four ways to increase revenue:

- 1) Increase the number of customers.
- 2) Increase the average amount of each sale.
- 3) Increase the frequency of sales per customer.
- 4) Increase prices.

In any case, you will need to invest time (and very likely dollars) to accomplish your goals. Using a percentage of sales to set your marketing budget has several problems:

- It is an irrelevant benchmark for what is too little or too much.
- It doesn't take into account your marketing goals or production capacity.
- It doesn't account for earlier marketing investments that continue to yield results.
- It doesn't reflect industry changes that you need to respond to.
- It doesn't consider the amount of risk appropriate for your current position.

What do you want to accomplish? This is the key question as you consider how much money to allocate for marketing activities. Will you be launching a new product line or continuing with your current offerings? How much growth do you want? Are there major issues to fix? What would be lost if enough sales were not generated? How much unused capacity do you have to fill?

Spending money on marketing can feel risky if you feel uncertain it will pay off. Like many aspects of running a business, we are never guaranteed our efforts will be successful in the way we envision. The answers to the following questions can help you determine the amount of risk to take on:

1. What is our net monthly cash flow?
2. Based on our experience, how confident are we that the initiative will succeed?
3. How much cash reserve do we have to fall back on?
4. What is the worst-case scenario if we do this? If we don't do this?
5. How stable is our business plan and historical performance?

Another aspect of managing risk is to take baby steps before attempting a giant leap. In their book *Great by Choice*, Jim Collins and Morten Hansen call this strategy “fire bullets, then cannonballs.” The analogy comes from the concept of a military saving its heavy artillery until the target position is calibrated using smaller weapons. The point regarding business is to test your plan in a small way to elicit real-life feedback before going all-in on a risky, expensive bet.

You can limit risk by budgeting money for experimenting with a new marketing initiative. If the results are positive, you can invest more resources with higher confidence and more experience.

### **How do I set priorities?**

You usually have more projects to complete than you have budget for. How do you choose which ones to keep and which ones to put on a waitlist? Your SMART Goals and KPIs determine these decisions (see the previous article in this series). The projects reflected in those goals get top priority in your budget. Fill in your most important tasks first.

*Your Annual Marketing Budget - Continued on Page 264*



**We're hiring!**

## Copywriter

- Write Advertising Copy
- Write Articles & Case Studies
- Gather & Organize Content
- Edit Client Supplied Content
- Client Communication

Full time or part time position. Remote work will be considered.



ROSEWOOD  
Marketing  
Myerstown, PA

*Learn more and download an application at [rosewood.us.com/careers](https://rosewood.us.com/careers) or email [roy@rosewood.us.com](mailto:roy@rosewood.us.com)*

### *Your Annual Marketing Budget - Continued from Page 263*

Next, consider if any projects will give you long-term benefits, such as building an e-commerce website, refreshing your brand, or erecting a digital sign where you can display messages. The reason to prioritize these projects is that choosing to do these projects now allows you to benefit sooner and longer.

Be willing to drop your pet project if it simply doesn't fit in your budget this year. Maybe you don't care for the look of your current sign, but if updating the sign doesn't help accomplish your SMART goals or KPIs, then you should back burner it for now.

You can also ask these questions to help you set your priorities:

- Where is our greatest weakness?
- Where is the low-hanging fruit?
- What will bring the quickest improvement?
- What will have yielded the most results one year from today?

#### **What categories should my budget include?**

Don't get hung up on the format of your annual marketing budget. Getting the content in place is more important than how you format the information.

To help you plan accurately, include costs for each of these categories in your budget, or you can adapt these to your liking:

- Market research
- Messaging development
- Lead generation
- Lead conversion
- Branding
- Testing & measuring
- Other

Completing projects to achieve your goals requires not just dollars but also time. Marketing projects don't get done by themselves. Someone needs to think about them, plan them, and execute them. Most marketing plan failure results from failing to schedule the necessary time for you or your employees to do the marketing tasks. Therefore, you need to not only budget dollars but also time. Ideally, your marketing budget will include the following elements:

- Dollars budget
- Time budget
- Calendar of events/deadlines
- Review and update cycle

Estimate how much time is involved with each project or each step in a project. This will help you be realistic about achieving it. When a subcontractor or marketing agency is involved, that expense goes into the dollars budget while your and your employee's time goes into the time budget. Assign responsibility to yourself or someone else for each project and set a start date and completion date.

For projects with phases, set a start and completion date for each phase. For example, think of what goes into a catalog project: Writing copy, photography, layout, and design, incorporating pricing updates, proofreading, and printing/mailing. Who will do each phase by when? Schedule these details into your calendar.

On your marketing calendar, schedule the events for the coming year: shows and expos, open house, sale dates, etc. Then schedule the start dates for the work that is done to prepare for those events: planning meetings, preparing new marketing collateral, placing advertisements. The people involved with or responsible for various aspects of the work should put those start dates and deadlines on their calendars.

Schedule time each month to review progress. Are projects moving forward? Are expenses in line with your projections? What should be re-calibrated? Of course, when another year rolls around, it will be time to start over and adapt your marketing budget for the coming year.

#### **Conclusion**

How much should you budget for marketing? I can't answer that question for you, but I also know you don't need to pluck a random number out of thin air. I hope this article has shown you a thoughtful path to finding a reasonable number for your business.

---

**About the Author:** Roy Herr is the senior marketing consultant at Rosewood Marketing. The Rosewood team guides business owners through marketing challenges into sustainable growth. You can reach the Rosewood Team at [grow@rosewood.us.com](mailto:grow@rosewood.us.com) or 717-866-5000.





\$675



\$550

All Products for Belt Drive Systems

We also sell Chop-Rite Meat Grinder & Frames

Seasonal Sale on Meat Grinders

UNTIL THE END OF DECEMBER

New All Stainless Steel Meat Grinders

Butchering Season is here. Process your own meat and save money!!!

High Quality Grinder. This Grinder is made from a high quality "stainless steel" material. Very easy to clean and keep sanitary. Includes 2 plates, with 3/16 and 1/4 holes and also handle and sausage stuffer attachment.



w/ motor \$850 or w/out motor \$650

15736 Burton Windsor Rd. • Middlefield, OH 44062

1-440-632-3427



# MIGHTY PROFITABLE SPLITTERS

IDEAL FOR LANDSCAPE MAINTENANCE AND RENTAL

## Made for the Kind of Wood Other Splitters Can't Touch

Loggers take everything 14" and larger up North where most splitters are made. Most wood splitters you can get are made in the North where trees tend to grow tall and straight, ideal for lumber, pulp and paper. So loggers take everything 14" diameter and larger. Only the smaller pieces are cut for firewood. That's why most log splitters are made to handle the smaller stuff, under 14" diameter.

Trees removed in suburbs and cities are overgrown and tough to split. But city and residential trees are different. By the time they need to be taken down they've grown irregularly and downright gnarly. There's a lot of firewood in those large trunks. But you need a splitter like Mighty Ox™ to do the job. Go ahead and look around. We did. That's why we don't think you'll find another readily available splitter designed and made like a Mighty Ox™. It's the compact and powerful splitter with profit built in.



Lighter Duty With Maximum Flexibility

Vertical or horizontal operation

### MIGHTY OX UP 'N DOWN™ MODEL V-20

Don't be fooled. When we say "Lighter Duty," we're comparing the versatile Up 'n Down with the other Mighty Ox splitters, not other commercially available splitters. What we call "light" is massive compared to any other splitter you can get. The Mighty Ox Up 'n Down is a great entry level splitter for handling a wide range of pieces, from 30" diameter to less than 14" diameter. Large pieces never leave the ground. Instead, the splitter is raised to the vertical position, and drives the wedge from the top down. Split pieces simply fall at your feet. For smaller pieces that are more easily handled, the horizontal position works at waist level. The Mighty Ox Up 'n Down is easy to transport and store.

### MIGHTY OX HIGH-PRO™ MODEL LS-30

High production splitting with less labor

Works best with wood 30" diameter and smaller.



Tension Wings won't let pieces fall to the ground.

Lifts up to 1,200 pounds!

### MIGHTY OX CHUNK BUSTER™ MODEL L-30

Splits the big stuff like it's eating a snack

For Landscape Crews and Rental. Engineered and built to handle logs up to 48" in diameter, making it perfect for breaking up "city trees" into saleable firewood. Other splitters aren't built for wood over 14" diameter. But that's where the Mighty Ox Chunk Buster really shines. It even lifts those big pieces hydraulically. The Mighty Ox Chunk Buster is compact, powerful, durable and easy to maneuver in tight spaces.



1/2" Steel Plate Log Cradle

Incredibly splitting power.

1/2" Steel Plate Log Cradle

Lifts up to 1,200 pounds



Professional Grade Wood Splitters

Contact: 717-455-9007  
Mighty Ox Equipment  
684 Paris Road  
Fort Plain, NY 13339

Made in the USA

DEALERS WANTED

# Mid Ohio Sliding Door Components

## Delrin Wheels with Ball Bearings

## Manufacturing Round Keyhole Track

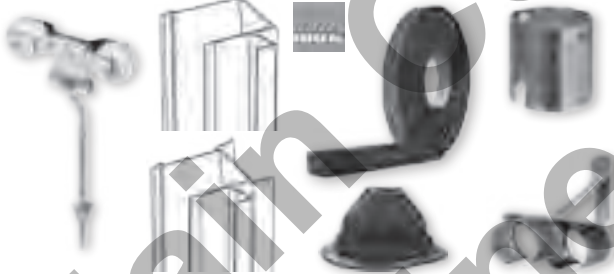

Palram Duraclad PVC Interlocking Liner Panel

Plyco Insulated Door



Sunsky 9" Clear



4 1/2"

— WHOLESALE ONLY —

FOR PRICING, WRITE TO: 7055 Twp. Rd. 82, Bellville, Ohio 44813

# Coffy Brake answer

October Winner 2021

Coffy Brake is sponsored by



PO Box 127, Millersburg, PA 17061  
(877) 278-1090



How many eggs?

If a hen and a half would lay an egg and a half in a day and a half; how many eggs would 12 hens lay in 12 days?

How many eggs would 12 hens lay in 12 days?

Answer:  
96 eggs

RANDOMLY SELECTED FROM THE CORRECT ENTRIES: Winner: Carl Stauffer, Lyndonville, NY | Wins a \$50 Gift Certificate from Sunrise Naturals.

To submit Coffy Brake Riddles, Send To: PCBE / Coffy Brake Riddles • P.O. Box 520, Millersburg, PA 17061



3216 CR 160  
 Millersburg, OH 44654  
 Ph: 330-359-5936  
 Fax: 330-359-0411

- Collar Pads
- Deep Curved Breast Pads
- Spine Relief Gig Pads

Full line of pads:

- Draft
- Standardbred
- Pony



We reinforce clips on collar pads to prevent tear out!



All pads are available with neoprene bottoms.

**WE ALSO SELL CARPET PAD & MARINE GRADE VINYL**

Wholesale & Retail  
 Call for a price list • We ship UPS or USPS

# HEALTHY, HAPPY HORMONES?

**POSSIBLE INDICATIONS OF BALANCED HORMONES:**  
 Full-term pregnancies | Pain-free cycles | Stable moods | Regular monthly cycles | Warm hands & feet | Ample milk supply  
 Healthy bones | Natural child spacing

We have been sharing these high-quality products since 2005.  
**CALL TODAY FOR YOUR FREE PACKAGE!**



## WHAT CUSTOMERS ARE SAYING\*

- "My husband can TELL if I'm using the products!"
- "My cycles are on time!"
- "We have a baby!"
- "My baby is 15 months old and my cycles still haven't come back!"
- "I'm pregnant after 11 years of marriage!"

## NUTRITION FOR NOW!

CONTACT: Emma Miller  
 9599 Senff RD Dundee, OH 44624  
**330.359.0243 | Best Hours:**  
 Mon - Thurs: 8:30am - 3:30pm

\*These testimonies cannot be construed as representative results everyone can achieve



**SERVING THE AGRICULTURAL AND SAWMILL INDUSTRY FOR OVER 21 YEARS**  
 CYLINDERS, PUMPS, MOTORS, VALVES - OVERHAUL OR REPLACEMENT



SAWMILL EQUIPMENT  
 DESIGN & ENGINEERING  
 POWERING & PLUNGING

**HOSES & FITTINGS**  
 MADE WHILE YOU WAIT!



**FASTPIPE**

COMPRESSED AIR PIPING & HYDRAULIC AIR SYSTEMS



**WE STOCK A LARGE SELECTION OF CHAR-LYNN/EATON MOTORS!**  
 WHOLESALE PRICES AVAILABLE

**Yoder Hydraulics LTD.**

12317 Dover Road  
 Apple Creek, OH 44606  
 Phone: 330.857.0001  
 Fax: 330.857.2446

## Financing Available **HORSE PREPPER TREADMILL**



- A great way to train young and problem horses.
- 51 pc. rollers between drums creates slight vibration to help loosen and build muscle.
- 7/16 thick rubber belt.
- NO engine to run to create dangerous fumes and sparks.
- Raise and lower incline with ease.
- Easily determine how hard your horse works with turn of knob.
- Keyed shaft on side to drive other components
- Heavy duty build.

For more information write:

**TROYER MACHINE - 6187 Woods Church Road, Walkhonding, OH 43843**

## CHICKEN NESTS

New galvanized 4 and 8 hole rollaway laying nests. They have a solid, removable floor under PVC coated 1/2x1/2 netting in nest part, wood slat and galvanized lid above egg tray. Assembles with 3/16" and 1/4" bolts. Proven performance.



8 Hole Unassembled \$ 260.00  
 4 Hole Unassembled \$ 150.00

Shipped with bolts and assembly sheet included. Write for shipping costs and brochure Please specify where you saw this ad.

**M&M Sheet Metal**  
 8825W 700S  
 Topeka, IN 46571

## COUNTRYSIDE FLOORS

Flooring Warehouse

STOCKING VINYL FLOORING, WATERPROOF VINYL PLANK, AND MORE

FREE SAMPLES  
 Shipped UPS

**Up to 40% Off on Select Items**

Installation Available

604 Schrey Hollow Road, Port Trevorton, PA 17864

570-374-5787

Monday, Wednesday, Thursday - 8:00am - 5:00pm  
 Tuesday, Friday - 8:00am - 7:00pm • Saturday - 8:00am - 1:00pm

Formerly known as DISCOUNT LINOLEUM







# Nickel Mine Coach Shop

New Carriages & Repairs



The England Cup Seal is a lot like the original USA cup seal use to be. The cross hatch in the brake wheel cylinder wall prolongs the cup seal's life. Brake wheel cylinder are also available with flange piston.

**Quality Stainless Steel Brake Wheel Cylinder**

**(610) 593-1375**

Leave a Message or Call between 8-8:15 am

# Custom Printed Carbonless Forms

Edge Bound				30 per Book			
2.25x 3.50x 2.5	4.25x 3.50x 2.5	4.25x 3.50x 2.5	4.25x 3.50x 2.5	2.25x 3.50x 2.5	2.25x 3.50x 2.5	2.25x 3.50x 2.5	2.25x 3.50x 2.5
100	200	300	400	100	200	300	400
940	1880	2820	3760	220	440	660	880
1000	2000	3000	4000	220	440	660	880
1000	2000	3000	4000	220	440	660	880
1000	2000	3000	4000	220	440	660	880

Business Cards \$40.00 / 500

#10 Peel and Seal Envelopes \$70.00 / 500

Personal Checks Duplicates \$65.76 / 600

White Ceramic Mugs 1 color \$2.64 ea.



1113 State Rd 5 and 24  
Gettysburg PA 17325  
Phone 717-427-0611  
Fax 717-427-1100  
james@mttech.com



## Office Technology and Data Services

Work on **Integrity**



Thinkpad T430  
Intel i5 processor  
and SSD drive  
**ONLY \$425**

Refurbished  
Laptops and Desktops-  
Locked down to your specs.  
A budget-friendly choice!

Email  
Spreadsheets,  
CAD drawing, and more.  
Quickbooks Setup

Ongoing **Bookkeeping Services**  
Including training, data entry,  
Monthly statement print and mail,



Easily manage income, expenses, and more.  
Organized and in one place

**Make your office a better place.**  
**Call for a free consultation.**

**StarLux Illumination Ph# 610-857-3630**

# A SONG AND STORY BOOK

of your favorite childhood songs!

A perfect gift for little ones in your life.



5 3/4 x 4 1/4  
Sturdy Board  
Books

**\$6.50** each  
Shipping Included

**WHOLESALE  
PRICING  
AVAILABLE**

## PRESCHOOL PRAISES

26448 Lippert Road, Cochranton, PA 16314



# HEALZALL, INC.

For Open Wounds on Animals  
**HEALZALL** will soften all skins  
and keep from cracking.

**Excellent for Pain from burns.**

**PATENT  
PRODUCT  
# 073-43E**

**Looking for dealers in select Areas**

For more info write to:

**Aaron Beechy**

2885 W. Wirtz Rd. Gladwin MI 48624

The only legal  
manufacture

# WORK HORSE

**HEAVY-DUTY  
FOLDING  
SAW HORSES**

- 1600 lb. weight capacity
- Compact, folding design
- Clamp on 2 x lumber, set up requires no screws or nails
- Powder-coated finish



**\$200.00 complete set**

**Ivan Reiff • 717-556-4161**

350 Peace Rd. Leola, PA 17540

# Speedi-Roll Gear Drive

DESIGNED FOR FAST  
BARN CURTAIN ROLL-UP



Curtain Closed



Curtain Open



Use anywhere  
you have a  
roll-up curtain

- Greenhouses
- Dairy Barn
- Horse Barn
- Hog Barn
- Poultry Barn
- Tobacco Shed
- Shop

RUST FREE ALUMINUM HOUSING  
AVAILABLE IN LEFT OR RIGHT

Handcrank Included

**INDIAN HILL**  
MANUFACTURING LLC

324 NORTH MT. HOPE SCHOOL ROAD  
WILLOW STREET, PA 17584  
717-464-6476



**CONNECT**  
WHOLESALE  
Supplier of Battery Connections



## Large Selection Of:

- Weld Cable
- Tray Cable
- Primary Wire
- Ring Terminals
- Fuses
- Heat Shrink Connectors
- Breakers and much more!

PLEASE CALL OR FAX FOR A FREE CATALOG AND PRICE LIST. WHOLESALE ONLY.

15680 Georgia Rd. Middlefield, OH 44062  
Phone 440-426-0048 • Fax 440-426-0035

## Who do you know that has a slow learner or angry, irritable Child?

Testimony: **The Kurtz Family, Ohio** - "We want to share how pleased we are with the Brain Vitality. Our 9 year old son has had many school related struggles. He redid 2nd grade, switched schools in November, this year in 3rd grade. He was evaluated by the Autism Center in December and they recommended prompt intervention from his school district for dyslexia and other issues. At our January conference his teacher agreed with us, showed us some writing samples, etc. Meanwhile, he started taking Brain Vitality in January. At the end of March I met with the school superintendent, principal, teacher, and reading specialist. Long story short, in those 2 months on Brain Vitality, he made such progress, they saw no need for intervention anymore! He has also quit wetting the bed, which has been another whole issue in itself. We even put him through an \$1800 program for bed wetters with no success! So, needless to say, we are huge fans of Brain Vitality!"



Send order with payment to:  
Reuben Fisher  
17741 S Rt 44 Allenwood, PA 17810  
Phone Orders: (570) 547-6343

**sisel**

## Dealers Wanted



Custom Hand Drawn  
Family Record Available

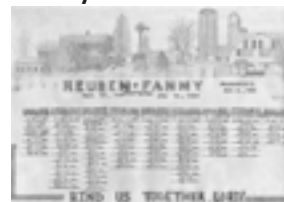

Calendar also  
includes two pages  
of funny stories.



**FREE SHIPPING**

Calendars also available at  
Yoders Blacksmith Supplies.....Fredericksburg, OH  
The Behalt.....Millersburg, OH  
Creative Crafts.....Myerstown, Pa

**To Order A Calendar  
Please Send Payment Of \$9.50 To  
Andrew King  
120 W. Reistville Rd.  
Myerstown, PA 17067  
Updates Call 717-454-9465**





**LIVING  
WATERS**  
BOOK & TOY STORE

3161 Fruit Ave  
Medina, NY 14103

P: 888.932.0209  
F: 877.595.7593

E: sales@lwcb.shop  
W: www.lwcb.shop

*Christmas Shopping Made Easy*  
with gifts from our line of quality kitchen and gift items!

**VALORE**



**Handy Slicer**

The serrated blades cut even slices quickly and efficiently.

**352-3919**

**\$9.99**



**Soft Grip Apple Slicer**

This soft grip apple slicer easily slices apples into 8 parts.

**352-3918**

**\$8.99**



**Salad Spinner 5.5L**

Features a smooth action ratchet handle that gives you more power with less effort!

**352-0801**

**\$29.99**

**Best Seller!**



**Food Chopper w Pull String**

Chopping and pureeing made easy!

**352-0798** 400 mL

**\$10.99**

**352-0799** 870 ml

**\$14.99**

**352-0800** 1.2 L

**\$16.99**



**Vegetable Chopper**

Prep, bake, & serve—all in the 11 cup glass dish! Includes 1/2" and 1/4" dicing grids. Dicing area measures 2 3/4" x 5 1/4"

**352-0802**

**\$34.99**



**Great Family Game!**

**Woods & Water Board Game**

Head for the wilderness and enjoy the thrill of the hunt! You'll need the right equipment and a little luck to outsmart your competition and tag trophy animals. 2-4 players, Age 10+

**650-0025**

**\$29.99**

**CONTACT INFO:**

Name: \_\_\_\_\_

Address: \_\_\_\_\_

Phone: \_\_\_\_\_

**MY ORDER:**

Yes! Send me a **FREE** catalog!

Item: \_\_\_\_\_ \$ \_\_\_\_\_

Item: \_\_\_\_\_ \$ \_\_\_\_\_

Item: \_\_\_\_\_ \$ \_\_\_\_\_

Mail in this slip or mention this ad to receive just **\$5 Shipping** on your order!  
Wholesale inquiries contact [wholesale@lwcb.shop](mailto:wholesale@lwcb.shop)

# FREE SHIPPING!

## Safe and Easy Trailer Mover Hitch

Move trailers efficiently with your forklift

**Act Now!**  
Offer ends  
December 24, 2021

No need to  
get off the  
forklift seat

Guaranteed Latch\*  
No Moving Parts

- Wide fork pockets to accommodate most fork positions
- Move multiple types of trailers and RVs with ONE attachment
- More stability and better control of the trailer



Tri-ball fits most trailers



Easy entry into hitch.  
Raise hitch to self-lock onto forklift

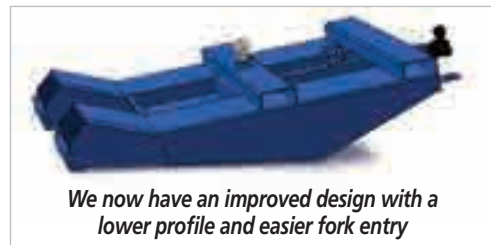

We now have an improved design with a lower profile and easier fork entry

### STANDARD FEATURES

- Gooseneck Trailer Hitch
- 3-way receiver to fit most trailers
- Storage Rack for Hitch Pins, etc.
- Wagon Pin Hitch

\*Applies only if forks are properly inserted and do not exceed 48"

This offer is for the SideKick™ Trailer Hitch only

### OPTIONS



5th Wheel Hitch

Lifting Hook

Side Kick™ is a new division of Iron Bull and is dedicated to manufacture and source products to increase forklift productivity and safety.



**Your forklift attachment experts**

A division of Iron Bull Mfg. LLC  
6064 N 350 E, Marshall, Indiana 47859

500 / 11-21

**Make your forklift more productive**  
**Call us today! 765-597-2489**



# CREATIVE PowerCell-utions

Woodgrain  
Aromatherapy  
**\$89.95**



# The perfect gift for anyone on your list!

Our battery-powered essential oil diffusers all feature portable, sleek designs to freshen up any room.

**Powered by the battery of your choice:**  
Makita • DeWalt • Milwaukee



White Ultrasonic  
**\$79.95**



Ultrasonic Woodgrain  
**\$89.95**



Jasmine Ceramic  
**\$89.95**

Keith Kaufman • 10695 W 700 S • Millersburg, IN 46543 • P: 260.350.4720 • F: 260.350.2683 • E: creativepower18@ibyfax.com

7880 Stony Point Rd. NW Sugarcreek, OH 44681  
**330-852-2600**



## Stony Point SUPPLY

*It is not what you got it's what you give that measures  
the worth of the life that you live.*



Hours: Mon.-Fri. 6:30 am to 5:00 pm  
Sat. 7:00 am to 11:30 am



**LL100N-2**  
Affordable,  
Easy to Use Laser Level  
Receiver- HR320  
Rod- GRI52 Metric,  
Tripod- Q104025  
Case- System Case

**LL300N-3**  
Medium-Range,  
Highly Accurate  
Leveling Solution  
Receiver- HL450,  
Power- 4-D Alkaline,  
Rod- GRI53 Metric, Tripod- Q104025, Case- System Case



**GL422N**  
Single and Dual Grade  
Lasers with Vertical  
Alignment  
Receiver- HL760,  
Clamp- C70 Adapter  
for receiver,  
Remote- RC402N



**LT56 Rugged  
Universal**  
Simple to use - Perfect  
for Interior  
Construction  
Receiver- HR220,  
Case- Hard Case

### HL450 Digital Readout Receiver

Ideal for use with any  
Rotating Transmitter  
Checking elevations, Basement  
excavation, Digging septic  
tanks, Checking foundations,  
Digging footings, Setting forms,  
Checking sub-base materials,  
Screeding concrete



### HL700 Digital Readout Receiver

Highly Versatile Receiver  
for Basic and Advanced  
Leveling and Aligning  
Checking elevations, Basement  
excavation, Digging septic  
tanks, Checking foundations,  
Digging footings, Setting forms,  
Checking sub-base materials,  
Screeding concrete

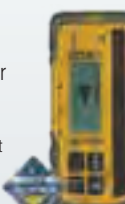

**HL760 / HL 760U  
Radio Digital  
Readout Receiver**  
Highly Versatile Receiver  
for Basic and Advanced  
Leveling and Aligning

Remote grade checking with  
cable free Remote Display,  
Wireless monitoring of  
foundations and steel erections,  
Risk free monitoring of tilt up  
wall position

**Setting and checking jobsite  
elevation and depth for:**  
Cut and fills and grading,  
Foundation, forms, and footings,  
Excavations

### MM-1 Magnetic Mount

Works with all LR receivers  
and quickly attaches to the  
dipper arms of excavators  
or backhoes, Strong dual  
magnet packs will not slip  
on the machine, Magnets are  
adjustable, can be positioned  
around hoses or piping,  
for quick installation and  
set-up, Release lever aid in  
detaching from machine

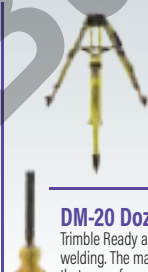

**Specialty  
Tripod-90550**  
Laser, Instrument,  
Machine control,  
Material- Fiberglass,  
Extension-Extends to  
5.9 ft (1.8 m)

**Heavy Duty  
Tripod-2161**  
Laser, Instrument,  
Material- Aluminum,  
Extension-Extends  
form 3ft 6in to 6ft 1in  
(105 cm to 185 cm)



### DM-20 Dozer Bolt-On Mast

Trimble Ready adjustable mount installs with no  
welding. The mast mount bolts instantly to machines  
that come from the factory

### Aluminum Grade Rods

Grading, Leveling, Sitework, Landscaping,  
Foundations Length- 15ft, Section- 5, Scale- Inches

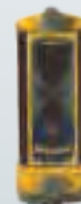

### LR60 Receiver Angle Compensation for Excavation

Machine mounted grade  
checking, Grading and  
leveling, Excavation and  
trenching  
Batteries- NIMH,  
Remote Display- RD20

**304 STAINLESS STEEL** NPT VALVES, FITTINGS & NIPPLES  
**WHOLESALE PRICES**

GATE VALVE    2 PC BALL VALVE    SWING CHECK VALVE    90° STREET ELBOW    UNION    COUPLING

Send your information NOW for our NEW 2020 Catalog & Contact Information

**Custom Cast**  
A FURNACE CITY COMPANY

Huge Inventory Blowout  
**WHOLESALE PRICES!**  
 Close through 6" pipe nipples in stock

Size
1/8"
1/4"
3/8"
1/2"
3/4"
1"
1 1/4"
1 1/2"
2"

Heavy wall thickness on 1000's of fittings IN STOCK 1/8 THROUGH 2"

WE SHIP USPS & UPS

4205 TOWNSHIP ROAD 629, MILLERSBURG, OH 44654

**HWC** THE HAMBURGER WOOLEN COMPANY SERVING THE AMISH-MENNONITE COMMUNITIES **FOR 80 YEARS**

Hamburger Woolen Company, Inc.  
 UNIFORM & CAREER APPAREL FABRICS  
 Certified as a Woman-Owned Business Enterprise  
 Family Owned and Operated Since 1940.

We stock all popular fabrics and want to be your fabric store and warehouse.

**We carry the following fabrics:**

- Baby Ottoman & Diagonal
- Twill Double Knits
- Pontil Double Knits
- Tri-Knits
- Garbardines
- Tropicals
- ...To name just a few

Please call for our free descriptive price list and free select samples. Wholesale inquiries and orders call toll free: 1-800-221-3464  
 Visit our website at [www.hamburgerwoolen.com](http://www.hamburgerwoolen.com)  
 Email inquiries to [irosen@hwcny.com](mailto:irosen@hwcny.com)

Hamburger Woolen Co., Inc.  
 PO BOX 796, 99 Second Avenue  
 Garden City Park, NY 11040  
 Phone: 516-352-7400  
 Fax: 516-352-7704

*"We have the lights for you!"*

When ordering an EZ-360, please indicate battery:  
 3110 = Dewalt  
 4110 = Milwaukee  
 5110 = Makita

Also, indicate the option you want:  
 0 = Button switch  
 1 = Pull chain  
 2 = Remote control  
 3 = Timer  
 4 = Motion sensor

Example: 31103 is an EZ-360 with a Timer for a Dewalt battery.

Battery & bulb for all EZ-360 lights sold separately.

**EZ-360 \$64.95**  
 (Shown right-side-up, at left, and up-side-down, at right)

Great for chicken houses!

**EZ-360 with Timer \$102.45**

**EZ-360 with Pull Chain \$71.45**

**1420 \$99.50**  
 Includes 10W bulb & shade. Battery not included.

**H.C. Lanterns**

**HC Lanterns 418 Furnace Rd, Quarryville, PA 17566 (717) 786-1049 (8-8:30 am)**  
 (Prices subject to change without notice. Prices in this ad do not include shipping.)

Wholesale inquiries welcome!

**Bringing Solutions to the Rollforming Industry** **STAR 1 PRODUCTS**

**Coil Rack**  
 Designed for 10,000 lb coils  
 12 Coil Capacity

**Adjustable Wide Forks**  
 A Solution to Handling Metal Packs from 13' to 40'

**Coil Tipper**

**Felt Applicator**  
 Easy Application  
 No Waste

CondensStop or DRIPSTOP

Ask for FREE Brochure.

**STAR 1 PRODUCTS**  
 2410 W Geers Rd, McBain, MI 49657  
 888-96-STAR1 • 231-825-0163  
 231-825-0164 (fax)



# WOODWORKING MACHINERY

Powermatic | Jet | Oliver | Laguna | Rikon | Shop Fox  
Safety Speed | JLT | SuperMAX | Kreg | Sand Pro and more...

We also sell **Jet** and **Edwards** Metalworking Machinery.  
Call for a **FREE** Machinery catalog!



**CONESTOGA**  
WOODWORKING SUPPLY

1564 Main St. (Rte 23) Suite 108  
East Earl, PA 17519

**800-445-4669**  
Fax: 717-445-5875  
conestoga@emypeople.net

**LAGUNA Jointer**



**POWERMATIC Shaper**

Our blankets are made with the lightest materials while still retaining the highest insulating properties.

# Esh Horse & Pony Blankets

817 Peach Lane • Nappanee, IN • 47778  
(717) 863-2200



**New Items**

Keep your newborns and puppies warm ...  
We now offer calf blankets and puppy blankets.  
To place an order, call us at (717) 687-7776.

**Buckle Snap**

**Wholesale or Retail**

## St. Croix Horseshoes with Drill Tec

	Regular Dress	Heavy Dress
000	\$4.45/shoe	\$5.45/shoe
00	\$4.70/shoe	\$5.70/shoe
0	\$5.20/shoe	\$6.20/shoe
1	\$5.70/shoe	\$6.80/shoe
2	\$6.20/shoe	\$7.20/shoe
3	\$6.70/shoe	\$7.70/shoe



**Mark Walling Mfg.**  
Manufacturing Steel Horseshoes  
P.O. Box 58, Bell Buckle, TN 37020  
**931-580-9073 • shoeman61@gmail.com**

## We rebuild Nicd Ni-Mh and Lithium batteries!

**Better Than New**

Please call for more details

### INNOVATIVE POWER LLC.

Battery Pack Rebuilding  
Lithium Sales & Accessories  
9515W 1350 N  
Nappanee, IN, 46550  
**574-354-8871**

Nicad Rebuilding	
1.2-12v	\$35
13-18v	\$45
19-23v	\$50
24-35v	\$85

Lithium Rebuilding	
1.5-2 Amp Hours	\$35
3-6 Amp Hours	\$60
7-9 Amp Hours	\$90
12 Amp Hours	\$130

Prices do not include shipping

## OAK LAWN BLADE

SALES AND SERVICE  
Ph: 270-465-0192 Fax: 270-465-0063

We have **GREAT PRICES** on 1" x 1 1/4" SWEEP MAX BLADES

- ▶ Great performance for all primary and secondary wood processing operations
- ▶ Expert sharpening service
- ▶ Includes gang, edger, scragg, trim, split and strobe saw blades

**Band Saw Blades Welded to the Length of your Choice**

**GUARANTEED WELDS**

**ASK ABOUT FREE SHIPPING ON BOX LOTS!**

**900 MERRIMAC RD, BRADFORDVILLE, KY 40009**  
**PHONE 270 465 0192 ▶ FAX 270 465 0063**

## ATTENTION STORE OWNERS!

USE AS ROOK CARDS OR TO PLAY ROOSTER OR ANY OTHER GAME THAT YOU PLAY WITH ROOK CARDS.



### THE ROOSTER DECK

**\$2.67 PER PACK**  
**\$32 PER DOZEN PLUS SHIPPING**  
**FREE SHIPPING ON 12 DOZEN OR MORE**

**WHOLESALE STORES ONLY!**  
**2 DOZEN MINIMUM ORDER**

5162 Parks West Road • Middlefield OH 44062 • (833) 693-4144

## NOW AVAILABLE



We now have copiers, cash registers, typewriters, and typewriters with memory.

Available in electric, 12 volt, and your choice of DeWalt, Makita, or Milwaukee cordless battery.

Contact us to order or with questions.

**VENTURE PRODUCTS**  
8228 E Moreland Road, Fredericksburg, OH 44627  
**330-698-1061**

**DeWalt**  
**Makita**  
**Milwaukee**

## SUNRISE LEATHER TOOL SYSTEMS



- **MAIN BAG:** Top corners and belt loop are riveted together for less sag. Crafted from 5-6 oz. chrome tanned leather for years of use.  
~ Left hand square slot ~ 1/4" Bit organizer in right bag ~ All stress points reinforced with stainless steel or copper rivets for durability ~ Nail puller loop on left bag ~ Plenty of room for pencils, small level, chisel, etc. ~ Options include tape measure holder and double small bag on right side
- **3" BELTS:** Crafted from 10-12 oz. veg tan leather with stainless steel buckles and rivets for years of comfort.

**WE ALSO MANUFACTURE RIDING TACK**

7629 N 150 W, Rochester, IN 46975  
phone: 574-223-4207  
fax: 574-223-3207

**Dealers Welcome**





# STOP! BEDWETTING

IT'S NOT THEIR FAULT!

Bedwetting is not the problem. At Dry Point Solutions, we work with the root cause, an improper deep sleep. They are just sleeping too soundly. With over 65-years experience, we guide each family naturally to the result it seeks...A Dry Bed.

**No Medications.**

WAKE UP TO A DRY BED!

Call Today! No More Hiding... We Can Help!  
**844 234-4050**

Dry Point Solutions 1250 S. Buckley Rd, Ste I-316 • Aurora, CO 80017

## QUALITY FARM MACHINERY

**GREAT FOR FOOD PLOTS**

**Precision Mowing**

- Non Plugging
- Low Torque
- Optional 3-point, trailing PTO, engine models, and even Ground drive models available.

**Cover Crop Roller**

- **Saves Time:** with the Cover Crop Roller, a farmer can roll and plant all in the same pass.
- **Improves Soil:** No-till cover crops supply nutrients, build organic matter, prevent soil erosion and reduce herbicide use.
- **Handles Tough Crops:** Cover-Crop Roller tests at 90% minimum crop knockdown and handles tough crops like hairy vetch and rye.



**I & J LLC**  
10 South New Holland Road, Suite 2  
Gordonville, PA 17529  
**(717) 442-9451**

**We also carry the following:**

- Garden Tools
- Ground Drive Forecarts
- Cultivators



*Bench Wagons & Benches Built to last!*

**Weaver Wagons & Custom Design LLC**  
5090 South Mt. Eaton Road • Dalton OH 44681 • 330.857.7811  
*Call for a Catalog!*



## SMUCKER WELDING SHOP LLC

- Custom Welding and Fabrication
- Shearing and CNC Press Forming
- Steel Retail, Bars and Plates Cut to Size
- Stainless Steel Water Troughs
- PTO Drive Lines, New and Repair
- Hydraulic Hoses While You Wait
- Power Transmission Products
- Hydraulic Oils



**SuperCrimp Conditioner**  
CRIMPING YOUR HAY EFFECTIVELY



**Discbine Roll Conversions**

2110 Rockvale Road, Lancaster, PA 17602 • phone: 717-687-0772



**SPECIALIZING IN GRANDFATHER CLOCKS**

- Grandfather Clock Sales and Service
- 2-4 dozen grandfather clocks in stock
- Over 100 New Models Available
- 40 page catalog with all our different styles available
- **FREE SHIPPING AND DELIVERY**

*Our catalog is not a parts catalog.*



**HICKS' CLOCK SHOPPE**  
215 E. Main Street,  
New Holland, PA 17557

CELEBRATING **25 YEARS** IN BUSINESS

CALL FOR A FREE 40 PAGE GRANDFATHER CLOCK CATALOG - 717-354-5108 EXT. 2



**AirPro Spray** SPECIALTY PAINTS & COATINGS, INC. **Air-Assist Cart**

**FULL LINE DISTRIBUTOR OF GRACO SPRAY EQUIPMENT**

**WE SELL & SERVICE MOST MANUFACTURERS!**

- Full Line Supplier of Spray Equipment
- Pneumatic Piston Pumps
- Diaphragm Pumps
- Spray Booths

**MAX CRIDER**  
Sales Representative

608 Alexander Spring Road  
Carlisle, PA 17015

Ph: (717) 249-5523  
Fax: (717) 249-5445





Many Kits in Stock  
and Ready to Ship!

VERY COMPETITIVE PRICES



Some of Our Most Popular Kits:

<b>Caterpillar<sup>®</sup></b>	3013 / 3014 / 3024 / 3034 / 3044 / 3046 / 3054 / 3056 / 3064 / 3066 / C2.2 / C2.2 CRDI / C3.3 / C4.4 / C6.6
<b>Cummins<sup>®</sup></b>	B & C Series 3.9 Liters / 4.5 Liters / 5.9 Liters / 6.7 Liters / 8.3 Liters
<b>John Deere<sup>®</sup></b>	300 / 400 / 500 / Power Tech / 3029 / 4045 / 6068 / 6081 / 6090 / Yanmar <sup>®</sup> Series
<b>Perkins<sup>®</sup></b>	3.152 / 4.108 / 4.203 / 4.212 / 4.236 / 4.248 / 4.318 / 6.354 / 104-22 / 403C-15 / 403D-15 / 403D-15 / 404C-22 / 404D-22 / 404F-22 / 704-30 / 804C-33 / 804D-33 / 1004.40 / 1004.42 / 1006.60 / 1103 / 1104 / 1106
<b>Yanmar<sup>®</sup></b>	3 & 4TNE84 / 3 & 4TNE84T / 3 & 4TNE88 / 4TNE94 / 4TNE98 / 4TNE106D & T / 3 & 4TNV84 / 4TNV84T / TK486 / TK486V / Marine / 3JH3 / 3JH3E / 3JH3CE / 4JH3 / 3JH4 / 3JH5 / 4JH4-TE / 4JH4-HTE / 4JH5E
<b>Mitsubishi<sup>®</sup></b>	S4S / S4S DT / S4K / S6S / S6S D / S6S DT / S6K
<b>Shibaura<sup>®</sup></b>	N4LDI / N843 / N843L / N844 / N844T / N844L / N844LT / N844L-D / N844LT-D / N844LTA-D / N844L-F / N844LT-F
<b>Kubota<sup>®</sup></b>	V1702 / V2003 / V2203 / V2403 / V3300 / V3800
<b>H</b>	DT360 / DT414 / DT436 / DT466

JANUARY  
SPECIALS!



On ALL  
MaxiForce Parts  
ordered between January 1 & 20

+PLUS+

5%

DISCOUNT

On Jobs Scheduled  
in January!

Valid on accounts  
in good standing

We Also Carry the  
Following Brands:



FULL ENGINE MACHINE SHOP!

Competitive  
Truck Freight  
Available



## SPRING GARDEN REPAIR

Specializing in Engine Machine Work



Call for Shipping Quote or  
FREE Wholesale Catalog

P 717.768.3860

F 717.768.3865

145 Spring Garden Rd.  
Kinzers, PA 17535

From the creators of Lancaster & Buckeye Puppies - We are happy to announce:

# PLAIN DIRECT

## A Product and Animal Online Advertising Service!

Plain Direct is an online advertising platform launched by Online Advertising LLC. It was created to offer a place where people can advertise anything from farm animals, home & garden supplies, and clothing to industrial farm and forestry equipment, metal & woodworking tools, and office goods. Plain Direct will also offer photography service in certain areas to make the advertising process easier!

Current Listings on Plain Direct.com:



For Questions or to  
Advertise, Contact:

Phone | 717.484.9581

Email | [info@plaindirect.com](mailto:info@plaindirect.com)

Website | [www.plaindirect.com](http://www.plaindirect.com)

Hours | Mon - Fri, 8 AM to 4 PM

Plain Direct is Hiring!  
We offer a \$500  
sign on bonus!





BUILT IN 2011  
**\$1,350,000**

# 81 ACRE FARM FOR SALE

SELLERS  
HENRY &  
EDNA MILLER

*This is a rare  
opportunity!*

1850 Co Hwy 1, Cisne, IL 62823 • Wayne County

**3504 SQUARE FEET • 6 BEDS • 2 KITCHENS • 2 FULL BATHS**



*A beautiful country homestead on 81+/- Acres*



## **81+/- Acre Farm with Homestead & Large Chicken Layer Barn**

81+/- acres with 6 bedrooms, 2 baths, 2 kitchens and a walkout basement. 36' x 64' with 9' fore chute detached, insulated garage. 34' x 60' x 8 horse stall horse barn with 36' x 40' attached hay/cattle shed. Large fenced in pastures for livestock. 40' x 80' partially insulated shop with 18' x 80' lean to. These buildings were built new in 2011. Also included is a 51' x 520' 20,000 bird commercial chicken layer barn that was built new in 2016. You will want to check out this excellent opportunity to purchase newer homestead on 81 acres with an existing organic chicken layer barn operation that allows chickens to roam in the fenced in pastures. There is plenty of wildlife in the timber on this property as well.

**For more information on this opportunity contact John Miller: 217-543-2883**

**INCOME  
PRODUCING  
OPPORTUNITY**

**WESTFORK**  
AUCTION & REAL ESTATE, LLC  
Your Auction & Real Estate Specialist



**John Miller**  
**Ph. 217-543-2883**  
Auctioneer & Mng. Broker License  
#471.018531-441.001855



**Laser plate cutting up to 3/4" Steel  
Custom fabricating and prototype  
building.**

**Short notice production runs.  
Solidworks CAD design.**



**B & M**  
Welding Inc.

*Add some spark to your imaginations!*  
(810) 837-0742



**BIOMASS ENERGY**  
TECHNIQUES INC

*The New Dimension In Renewable Energy*

**BIOMASS BURNER SYSTEMS**  
FUELED WITH GREEN SAWDUST, WOODCHIPS, HOG FUEL, ETC.

**Interested in producing biochar?**

Contact us today for information on

**BET 24-S**  
Pyrolysis Rotary  
Drum System



**BET 111**  
Burner  
270,000 BTUs



**BET 24-S**  
with BioChar System  
1.4 mil BTUs.

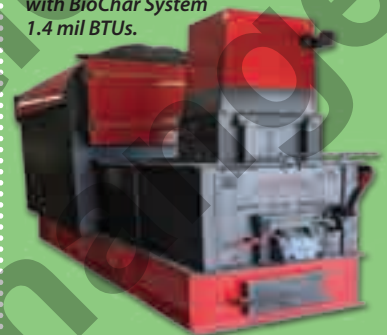

**We service all models of Conifer Burners**

12969 Rockafeller Road, Versailles, MO 65084

Office: 573-378-2228 • Fax 573-539-2548

Email: [info@biomassenergytechniques.com](mailto:info@biomassenergytechniques.com) • Web: [biomassenergytechniques.com](http://biomassenergytechniques.com)

**WE HAVE YOUR TRACK**

and undercarriage parts for **OVER 6,000** Models of Equipment

KUBOTA



CAT



JOHN DEERE



BOB CAT



**MOST BRANDS  
IN STOCK  
GUARANTEED  
TO FIT**

**ROLLERS • SPROCKETS • IDLERS**  
Steel & rubber over the tire tracks also available.



**DJ'S GENERAL REPAIR LLC**  
2407 Pearsons Corner Road, Dover, DE 19904

**302.423.5690**  
Leave message if no answer

ONLY 70 MILES FROM  
LANCASTER COUNTY  
DELIVERY AVAILABLE

**Steinsammer**



**Trucking  
available**

**Grapple's for all size machines — Walk-behind Skid Steer's, Compact Tractors, Skid Steers, Telehandler's, Large Wheel Loaders**

**BURKHOLDER** **Need it Customized! Just Call**  
**EQUIPMENT LLC** **717-532-7337**

107 Hammond Rd. Shippensburg, PA 17257 | Fax: 717-477-9010  
[BurkholderEquipment@ibifax.com](mailto:BurkholderEquipment@ibifax.com)

**DEALERSHIP'S AVAILABLE IN SELECT AREAS**



# Confidence in Every Cut

Universally mounted on any sawmill equipment, shear, table saw, or anywhere you need confidence!

**Ultimate**  
Cutting Soon!  
Durable/Affordable

**ELITE**

The **PREDATOR** Hunting Light series  
"A laser light for a hunter then."  
250 yards to 600 yard shooting options  
Affordable to High end models  
Interchangeable Bells include:  
Green, Red, Blue, Infrared

In any cut, on any machine, the Elite Line laser is the most adaptable and high quality laser module that comes at an affordable price. With a laser line on your cut you will gain that full confidence in every move...

- Shock Resistant
- Vibration Resistant
- Seals, Saws protected
- Reverse polarity protection

Specifications: 2000-2200 nm, 200-6000 mW  
Power: 12V, 300, 1000-6000 mW  
Current: 77-2000 mA/10A  
Output: 300000, 900000  
Laser束直径: 2-20mm (0.078-0.787")  
Body Diameter: 1.5 (39.14 mm)  
Made in USA  
Laser Angle: 90 Degree

Ridalgo Lasers and Lights  
**606-278-2014**  
151 Sage Valley Rd  
Monticello KY 42633

Laser Pointers

# CUSTOM BUILT POWER UNITS

Deutz	F3L912	45 HP	Rebuilt
Deutz	F4L912	65 HP	Rebuilt
Deutz	F3L1011F	32 Hp	Rebuilt
Deutz	F4L1011F	42 Hp	Rebuilt
Deutz	BF4L1011F	72 Hp	Rebuilt
Deutz	BF4M2012C	125 Hp	Good Used
John Deere	4045HF285	115 Hp	Good Used
John Deere	6068T	170 Hp	Rebuilt
Cummins	4BTA3.9	110 Hp	Good Used
Yanmar	4TNV84t	36 Hp	Like New
Deutz	TCD914L6	164 Hp	Rebuilt
Deutz	F2L511	20 Hp	Good Used
Mitsubishi	6d14T	145 Hp	Good Used
Hatz	2G40	12 Hp	New Surplus
Cummins	855	400 Hp	Rebuilt

570.539.4804 Many More Available

**SENENIG DIESEL SERVICE LLC**  
Delivery Available On All Diesels Also Ship Motor Freight

1806 Troup Valley Road, Mt. Pleasant Mills, PA 17853 Since 1982

# No. 96T Heavy Pulling Collar



— The Original —  
**Loogootee Pulling Collar**  
Our superior pattern & heavy, tough leather makes this collar the choice of most pullers and loggers.

- Also manufacturing:
- ◆ Field Collars
  - ◆ Buggy Collars
  - ◆ All-purpose Collars
  - ◆ Adjustable Collars
  - ◆ Synthetic Collars

Ask your local harness shop about our collars.  
If there isn't a dealer in your area call or write for our color catalog.  
Harness and tack shops, ask for wholesale price sheet (include tax number).

**SUGAR VALLEY COLLAR SHOP**  
18 Wagon Wheel Lane  
Loganton, PA 17747  
(570) 725-3499 ext. 0

**Trail Battery and Solar**  
Redefining energy at home and work

**FREE SHIPPING**

## Do-It-Yourself Solar Kits Urban Power Packages

Everything you need for Solar Power in one economical package!

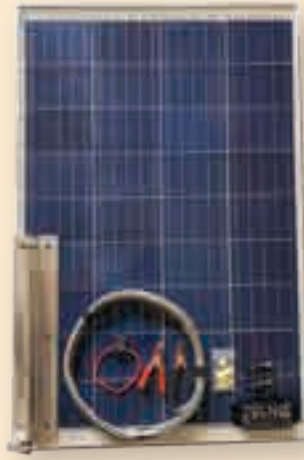

- The Shack** – 50 Watt Panel
- The Chicken Coop** – 100 Watt Panel
- The Camper** – 150 Watt Panel
- The Lodge** – 280 Now 330 Watt Panel  
Get 50 Extra Watts for Free!

**Residential, Farm and Business**  
Our team can install either off-grid systems or grid tie systems on your property!

5977 State Route 515, Millersburg, OH 44654  
330-893-7033 • Fax 330-893-1070 • trailbatterysolar.com

# Machinery Trader

ITEM	AD DETAILS	CONDITION	PRICE	NAME	CONTACT INFORMATION
Moulder	6 head ultra, model 623	Excellent	\$18,000		
Gang Rip Saw	SCMI 14 inch model M3, extra blades	Good	\$6,000		
Planer	Northtec double sided Stratta plane	Good	\$15,000	235 Woodworking	9290 TR 235, Fredericksburg, OH 44627 Phone: 330-946-2230
Chop Saw	Hitachi compound miter with MVM stand	Like New	\$900		
Give Rack	30 section 12 foot quick with 12 foot give APP	Like New	\$50,000 OBO		
Sawmill	Meadows #1 circular sawmill, 32 foot track, all dismantled, delivery available	Good	\$20,000 OBO	AJ Wood Products Andrew J Hershberger	497 Trout Rd, Northern Cambria, PA 15714 Phone: 814-948-5438 or 814-421-6286
Sliding Table Saw	SCMI model SI 16W, new bearings, scoring blade, 10 foot travel, 3 phase electric	Decent	\$2,600		
Miter Saw	Omga model 1L300, 12 inch blade, 3 phase electric, brand new	New	\$1,150	Alvin Shirk	819 Lauschtown Rd, Denver, PA 17517 Phone: 717-336-9044 Fax: 717-335-3304
Hoffman Dovetail	Hoffman model PP2 dovetail key machine for mitered corners, 110 volt electric	Good	\$2,200		
Trim Wrapper	With two 2 foot x 10 foot live conveyers, motor or lineshaft ready	Like New	\$10,000		
Pallet Racking	4 8 foot sections with 4 shelves per section	Excellent	CALL	Amos Coblentz	27091 V Drive South, Homer, MI 49245 Phone: 517-542-2025 7:30 - 8:30 AM
Cantilever Racks	2 heavy duty sets, 3 lighter sets	Excellent	CALL		
Stroke Sander	40" x 80" surface 6" belt heavy machine. Located in Summertown, TN	Good	\$1,000 OBO		
Pandagraph	Routs name and address in wood. Located in Summertown, TN	Very Good	\$700	Amos J Hershberger	15565 Combs Road, Laurelville, OH 43135
Diesel	Used Kubota D905 W clutch & panel 20 hp	Nice Runner	\$2,700		
Diesel	Deutz 2011 series 64 HP W/ clutch & panel	Call	\$5,800		
Diesel	Deutz 1011F Turbo W clutch & panel , engine is as new - paint still on turbo 71 HP	Call	\$6,300	Anderson Diesel Barn	Anderson Diesel Barn Phone: 724 967 3612 Fax: 724-748-5580
Diesel	Used John Deere 4045 with clutch & panel	Call	\$4,800		
Diesels	Other engines from 7HP to 275 HP.	Call	call		
Band Saw Mill	Perkins Diesel, 1 1/2" bands, 26" wheels, Hostetler brand	New	\$24,900		
Offbearer	Mellott-belt & sidekick roll fits Frick meddows etc.	Excellent	\$2,900		
Slab Edger	Morgan, can be used to edge boards too	Good	\$3,900	Andrew Miller	11577 Armison Road, Fillmore, NY 14735 Phone: 585-567-8083 M-W-F 8:30 to 9:00 AM only
Band Sharpener/setter	Brubacher with stands and Honda motor	New	\$4,900		
Air Clutch	Nexen L-600 #805260	Excellent	\$400	Andrew Miller	128 Co Rte 58A, Mexico, NY 13114 No Phone
Electric Motor	Delta 5 hp, 1 phase, almost new out of Delta unisaw, switches included	Excellent	\$350		
Table Saw	Rikon 10 inch left tilt contractors table saw on castors with 30 inch rip fence	Good	\$700	Andrew Slabaugh	60 St Rt 95, Jeromesville, OH 44840 No Phone
Hydr Pump-Motor	Hybel SM1213 0.81 CID 3,300MAXrpm 4,350MAXpsi SAE12 2pc available	New Surplus	\$146		
Hydr Pump-Motor	Hybel SM1211 0.81 CID 3,600MAXrpm 4,350MAXpsi SAE12 3pc available	New Surplus	\$142		
Pipe Coupler	2" SS pipe couplers, Cast, Aprox 50pc	New Surplus	\$9	AZS Brusher Equipmen	821 Crooked Lane, Ephrata, PA 17522 Phone: 717-733-2584 Fax: 717-733-4567 Email: azsbrusher@ibyfax.com
Generator	Honda EU7000IS 7000Watt Honda Invertor Duty, Ultra Quiet, Electric Start never used 1pc	New Surplus	\$4,449		
Air Filter	2W239 24" x 24" x 4" Pleated air Filter Merv7 - fits any 24" x 24" x 4" + opening 20+	New Surplus	\$17		
CNC Plasma	2013 Baileigh Industrial PT5x10 downdraft, Hypertherme 3070 High Def plasma	Needs Work	\$12,000		
Log Deck	4 strand, 50 foot long log deck, electric motor and gear box	Like New	\$9,000		
Incline Deck	4 strand, 14 foot wide X 20 foot long, electric motor and gear box	Good	\$4,000 OBO	Benjamin Beiler	3905 Willow Rd, Spitzer, WI 53825 No Phone
Shavings Baler	All mechanical, automatic stroke with no air, electric, or hydraulics, free literature	Brand New	Ask	Bens Repair Shop Ben Brenneman	18401 Fillmore Rd, Stanwood, MI 49346 No Phone
Wind Turbine	Generator with prop and controller	Good	\$675	CDS LLC Elam S Stoltzfus	3236 Craig Drive, Hartville, MO 65667 Phone: 417-241-0394 Fax: 417-741-2754 Email: cdsllc@ibyfax.com
Shaper	Powermatic 2700, 3 hp single phase, includes PF-31 3 roll power feeder	Very Good	\$2,950	Choice Cabinetry Mervin Martin	346 Gosling Marsh Rd, Martinsburg, WV 25404 Phone: 304-267-1485 Fax: 304-267-1486
Ironworker	Uni Hydro Pro 80, 4 station single phase, in stock, new	New	\$19,500		
Ironworker	Uni-Hydro 30-150 ton, 3 or 4 station, 1 phase, 3 phase, or non-electric, free shipping,	New	Call for price		
Log Splitter	30 inch x 42 inch capacity, skidsteer mount,	Excellent	\$2,100	City Hill Fabricating LLC	1064 City Hill Rd, Penn Yan, NY 14527 Phone: 315-759-3049 Fax: 315-536-4576
Ironworker	Uni Hydro Pro 80, 4 station single phase, in stock, new	New	\$19,500	Marvin Nolt	
Ironworker	Uni-Hydro 30-150 ton, 3 or 4 station, 1 phase, 3 phase, or non-electric, free shipping,	New	Call for price		
Log Splitter	30 inch x 42 inch capacity, skidsteer mount,	Excellent	\$2,100		
Dust Collector	13 inch blower, baghouse, cyclone, airolock	Good	\$10,000 OBO	Clearspring Mfg Jr Beechy	4225 W 350 S, Topeka, IN 46571 Phone: 260-593-2086 x 2 Fax 260-918-9499 Email: jr@clearspringmfg.com
Software	Cabinet Vision software, Super Pro with key	Unused	\$2,500	Country Value Woodworks Jonas	2302 Beaver Valley Pike, New Providence, PA 17560 Phone: 717-786-7949 x 1 Fax: 717-786-3626
Clamp Carrier	12.5 foot James L Taylor automatic clamp carrier, 20 section	Used	\$25,000	Countryside Woodworking Omer Kuhns	550 N CR 240 E, Arthur, IL 61911 Phone: 217-543-4190 Fax: 217-543-4195 Email: countrysideww@yahoo.com
Clamp Carrier	Doucet clamp carrier, 20 section, 52 inch clamps, heavy duty	Good	Call	Custom Reproduction Furniture/Paul H Nolt	513 Old Rd, East Earl, PA 17519 Phone: 717-445-4703 Fax: 717-445-4998



ITEM	AD DETAILS	CONDITION	PRICE	NAME	CONTACT INFORMATION
Diesel	Cummins 750 hp, KTA 19-G4, 2000 hour, year 07	Runs Good	\$10,500	Dannie Miller	27372 430th St SE, Fosston, MN 56542 Phone: 218-435-2010
Diesel	Deutz 254 hp, BF6L513 in line, 6 cylinder, 600 hours since rebuild, MSDP	Runs Good	\$10,500		
Diesel	Cummins 280 hp, M-11 year 07, mechanical gover, power unit MSDP	Good	\$9,500		
Diesel	Perkins 15 hp mechanical 3 cylinder, # 5 Bell, 15 hp @ 1800 rpm	Brand New	\$1,250		
Diesel	John Deere 6619 TT-02, need rebuild, # 038120 RG	Don't Run	\$850		
Diesel	Perkins, 165 hp, 354-T, black oil after cooling, clutch, radiator, low hours, MSDP	Runs Good	\$6,500		
Mini Excavator	35D John Deere mini excavator, cab, 3059 hours, cab is bent and windows broke	In Use	\$18,000 OBO	Deerfield Concrete/ Joseph Oberholtzer	1425 Beaumont Ave, Charles City, IA 50616 Phone: 641-228-3899 Email: deerfieldconcrete@abcmailbox.net
Power Unit	60 Series, Detroit 12.7 L, 7300 hr. on factory reman, DDEL #	excellent	call	Definitive Millworks	207 Sawmill Road, Liverpool PA 17045 Phone: 1-570-837-9688
Oil Cooler	American Industrial oil cooler	good	call		
Pump Skid	7' X 10' pump skid with line shaft, pumps, pulleys, sideload block,	excellent	call		
Air Compressors	Quincy air compressor, model 370	good	call		
Oil Reservoir	6-2" suction parts, 360 gallon	good	call		
Skidloader	2009 Case series III, 74 hp, cab, 2 speed, hi-flow hydraulic, 2495 hours	Excellent	\$29,500	Duane Diener	586 N CR 325 E, Tuscola, IL 61953 Phone: 217-208-9595
Edge Sander	Crouch edge sander, with extra belts	nice	\$3,500	EH Woodworking Sidney Burkholder	1763 Weaverland Road, East Earl PA 17519 Phone: 717-445-6595 Fax: 717-445-9717
Drawer Sander	Drawer Box Sander, 18" belt, with extra belts	good	\$4,200		
Phase Converter	40 KW Digital rotary converter booster	good	\$5,000		
Green Giant Forklift	6000 LB Capacity, 120" Rise, 50" str, Honda or Brilliant Powered, Mech. Dr., w/ poly or steel wheels	New	\$9,100	Eli D Shrock	For brochures or to place an order write to: 4250 S. Funk Road, Wooster, OH 44691
Green Giant Forklift	10,000 LB Capacity, 120" Rise, 50" str, Honda or Brilliant Powered, Mech. Dr., w/ poly or steel wheels	New	\$11,600		
Green Giant Forklift	3000 LB Capacity, 120" Rise, 42" str, Honda or Brilliant Powered, Mech. Dr., w/ poly or steel wheels	New	\$6,500		
Green Giant Forklift	3000 LB Capacity, 60" Rise, 42" str, Honda or Brilliant Powered, Mech. Dr., w/ poly or steel wheels	New	\$5,900		
Shaper	Unique 330 with 3 sanding heads, hydraulics	very good	\$4,800	Elm Crest Furniture	322 west Newport Road, Lititz PA 17543 Phone: 717-625-3411
Clamp	Drawer box clamp	good	\$500		
Natural Gas Engine	Zenith, 12.9 L, natural gas engine, 2600 hours, for parts or fix up	Parts	\$600	Elroy Yoder	3828 72nd St, Newaygo, MI 49337 Phone: 231-924-6621
1" Cherry Wood	2400 bd. Ft. Cherry, KD, planed 7/8, straightlined one side, 2 1/2"-7" width	Call	1.50/bd. Ft. OBO	Enos King	3094 Sowers Road, Greensfork IN 47345 Phone: 765-886-5748
Edge Sander	Jet, model # HES-6108-1, 6 inch, 1.5 hp	Very Good	\$850	Ervin Martin	1246 Sheep Hill Rd, East Earl, PA 17519 Phone: 717-355-0596
Dovetail Jig	Omni Jig 16 inch, Porter Cable, 5 templates	Like New	\$450		
Table Saw	Powermatic 72A, 14 inch, 3 ph	Fair	\$1,175		
Shaper	Seco SK-26SP, tilting arbor, 4 spindles, 1 ph, 5 hp	Very Good	\$2,200		
Spindle Sander	Wonder Grinder Co, Erie, PA oscilating, 7 spindles	Good	\$400		
Dust Collector	UFO-102B, 4 bag, 3 hp, 1 ph	Good	\$390		
Sliding Table Saw	SCM minimax SC3W, year 2001, 4.8 hp, 230 v, 3 ph, overhead arm guard, scoring blade, riving knife, Italian made, 2 12 inch blades included	Near Perfect	\$4,950 OBO	Evan Blades	27898 110th Street, Unoinville, MO 63565 Phone: 660-216-8048 Fax: 660-947-3355 Email: woodenbladeworks@ibifax.com
Wheel Loader	JCB 409 ZX, cab, heat, air, 75 hp. 5000 hrs. bucket and forks	EXCELLENT	call	Fishers Fabricating Mervin Fisher	6756 Mcclays Mill Road, Newburg PA 17240 Phone: 717-360-7884
Hole Borer	Hole Boring machine, 240v, saves drill press fatigue on volume and repetitive jobs, has auto retract, keyless chuck. Pictures available.	very good	\$650 OBO	Frost Mountain Woodshop Marvin Zimmerman	211 Main Street, Brownfield, ME 04010 Phone: 207-256-0461
Exhaust Fan	Dayton 18 inch explosion proof tube axial fan with single phase electric motor	Very Good	\$900 OBO	Gary Hershberger	2930 S 625W, Topeka, IN 46571 Phone: 260-593-0888 Fax: 260-593-0868
Press Brake	14 foot, 225 ton Dreis Krump Mfg Co. serial # 6873, hydraulic two speed	Good	\$20,000	Greentree Machine Works	Quarryville, PA 17566, Phone: 717-725-8644 Email: greentreemw@ibifax.com
Wood Furnace	HeatMor model 800 outdoor wood furnace	Good	\$6,000	Happy Farm and Greenhouse John Daniel Zimmerman	3370 Monkey Norman Rd, Hopkinsville, KY 42240 Phone: 270-889-5339 Fax: 270-885-8310
Table Saw	Delta Unisaw, 10 inch, complete with fence system	Excellent	\$1,275	Harmony Custom Kitchens Leroy Gingerich	12990 Cty Rd 15, Harmony, MN 55939 No Phone
Band Saw	20 inch Seco	Excellent	\$975		
Drill Press	Wilton, adjustable speed on the go, no need for step pulley	Good	\$650		
Bench Drill Press	Dunlap, heavy old style	Fair	\$375		
Planer	36 inch Greenlee, 4 knife cutterhead with sharpener, model 110	Good	\$6,000 OBO	Henry L Zook	18916 Game Rd, Preston, MN 55965 No Phone
Diesel	Cummins HR1 with clutch-runs	used	\$2,495	Henry Yoder	3604 st. wwy. 11B, North Lawrence, NY 12967
Dovetailer	OMEC 650M manual single spindle hydraulic, ready to go	New	\$8,400 OBO	Herschberger Woodworking	151 E CR 300 N, Arthur, IL 61911 Phone: 217-543-4075 Fax: 217-543-4085

# Machinery Trader

ITEM	AD DETAILS	CONDITION	PRICE	NAME	CONTACT INFORMATION
Forklift	2007 Hyster ESSZ-33 5500 lb, 36 volt, electric	Good	\$9,500		
Forklift	Raymond C50 HM 5000 lb, 36 volt, side shift	Nice	\$9,500		
Forklift	2002 Mitsubishi, FB20KT 4000 lb, 36 volt, 3 wheel	Excellent	\$8,900		
Forklift	2008 Yale ERC040, 4000 lb, 36 volt, 3 stage, side shift	Good	\$6,900		
Forklift	2009 Hyster E30Z, 3000 lb, 36 volt, new battery, side shift	Excellent	\$12,900	Hoover Enterprises	Stevens, PA 17578 Phone: 717-335-0050 Fax: 717-335-0053
Forklift	2002 Hyster J30XMT2, 3000 lb, 36 volt, new battery	Excellent	\$10,500		
Forklift	2008 Cat ES3000, 36 volt, stand on, side shift	Excellent	\$8,900		
Forklift	2008 Yale 4500 lb, stand on, 36 volt, side shift	Excellent	\$6,900		
Pallet Jack	Many walkie and rider pallet jacks	Call	call		
Swenson Shear	Swenson Shear snap table on trailer, for standing seam	Good	\$7,500	Hostetler Metal Sales Daniel D Hostetler	58644 Red Arrow Hwy, Hartford, MI 49057 Phone: 269-999-6242
Planer	33 inch Northtec hydraulic with spiral head	Good	\$9,500		
Rip Saw	Diehl straight line, hydraulic with laser and 4 blades	fair	\$3,500	Jake Zook	4021A Old Philadelphia Pike, Gordonville, PA 17529 Phone: 717-768-8930
Table Saw	10 inch jet hydraulic with 52 inch fence and miter, tilt	Good	\$750		
Dust Collector	Grizzly, 4 bag with bags, hydraulic	Good	\$600		
Barfold	Pexto 30 inch barfold, 2 to choose from	Fair	\$600 OBO		
Shears	Pexto LVD 10 ga 10 foot 1974 hydraulic shear, power back gauge	Used	\$5,500 OBO		
Lock Former	Flagler 24 ga Junior Pittsburg SN J-4858 11-97	Excellent	\$900 OBO		
Spot Welders	Spotwelders, 440 volt, 50 KVA	Call	CALL	JA-Mar Metalcraft	3095 Morton Lane, Trenton, KY 42286 Phone: 270-466-0905
Elbows	We manufacture stainless steel elbows and stovepipe 304	Call	CALL		
Wanted	Square cupalo patterns wanted	Call	CALL		
Rollers	Ferguson double steel drum rollers, JD 219 Ford diesel, 17-20,000 lbs	Runs	CALL		
CNC Plasma	2005 AKS 6 foot x 10 foot downdraft, Hypertherm HPR 130 hi-def with Tru-Hole, 1 1/4 inch capacity	Good	\$40,000 OBO		
Hydraulic Tank	70 gal 18" x 24" x 48", 20 hp, 3 ph, 24 gpm, with solenoid valve and regulator, full	Good	\$450 OBO	JM Shirk Mfg, LLC	459 Peach Rd, Ephrata, PA 17522 Phone: 717-721-3383 Fax: 717-721-2559
JD Parts	7000 7200 planter wheels, lift axles, transmissions, 7200 6 row rigid frame, heavy	Used	Make Offer		
Subsoiler	R65P1 single shank pull type horse drawn, trip rolling basket, no till, rental unit	Good	Call		
Welders	Zena welders, 200 amp DC each, join for 400, use with tractor, pickup, etc, very little use	Little Use	\$800	Joel Horst	PO Box 244, Port Clements, BC, V0T-1R0 Phone: 250-557-4589 Fax: 250-557-8573
Wide Belt Sander	Sanding Master, model # CSB-2-900, 37 inch, 220 volt, 3 phase, 2 head	Good	\$5,000	Keith Sensenig	7635 Amstutz Rd, Shiloh, OH 44878 Phone: 419-896-3176
Planer	SCMI S520 20 inch, 9 hp, 3 sets blades, 3 phase, 1998 power table	Very Good	\$5,900		
Sawdust/Grain Bin	72 inch diameter, 13 foot tall, 125 cubic feet, metal, 12 inch slide gate	Very Good	\$2,000	KenKraft Co Inc. Ken Spitulski	821 N Westwood Ave, Toledo, OH 43607 Phone: 419-270-0403 Fax: 419-536-0944 Email: hardwoods@kencraftcompany.com
Pressure Feed Tank	Devilbiss QMS747 galvanized steel pressure pot feed tank, 15 inch high x 15 inch diameter, 24 foot hoses	Good	\$300		
Truck Tool Box	Aluminum truck crossbed toolbox, full size, 1 lift door 18" w x 70" long	New	\$200		
Pellet Stove	Burns corn, pellets, etc, Golden Grain model 1101, made in USA, 14,000 to 40,000 btu	New	\$1,995		
Kiln	CRESS ceramic kiln for pottery	Good	\$200		
Linseed	55 gallon pure linseed oil	Good	\$2,100	Kyle Palumbo	6654 Middlebury Rd, Keymar, MD 21757 Phone: 410-984-3540
Punch Press	Diacro hand turret punch, 12 station	Good	\$1,800		
Profile Grinder	Weinig model R950, 230 volt, 3 phase, 2003	Very Good	\$5,000	Lamar Martin	3298 Delooza Rd, Penn Yan, NY 14527 Phone: 315-536-0525
Profile Grinder	Weinig model R925, some parts missing, 1994	Good	Best Offer		
Line Boring	USA made Conquest, 23 drill bits, 30" drilling span, single phase, 220 volt	like new	\$2,400	Levi King	1447 May Post Office Road, Quarryville PA 17566 Phone: 717-806-2099
Wanted	Table blaster, 60 inch or 72 inch, prefer Pangborn brand, will consider other brands	Call	CALL		
Wanted	Broach cutters for Davis No 5 key senter machine, need sizes 1/2, 5/8, 3/4, 7/8, 1, 1-1/4 inch	Call	CALL	Machine Shop Services	17928 Abbey Drive, Wheeling, MO 64688 Phone: 660-659-2011
Wanted	Pickering 1-1/4 inch ball ranger steam governor	Call	CALL		
Press Brake	Mechanical, Wysong 2572, tooling, electric, could convert to air or hydraulic, pics available	Good	\$4,000		
Riveters	3 to choose from	Fair	\$395 OBO	Martin's Maintenance	745 Lack Rd, Elkton, KY 42220
Uncoilers	2 to choose from, 26 inch wide with arm	Good	\$1,100 OBO	Marvin Martin	Phone: 270-265-5040 Fax: 270-265-5044
Leveler/Feeder	2, Little, 12 inch wide, Rowe, 15 inch wide, .030 - .125 capacity	Call	Make Offer		
Phase Converters	Martins Electrical digital rotary phase converter, model F24-22, 24 kw, 30 hp	Good	\$5,500	Martin's MFG	8135 Malone Rd, Shiloh, OH 44878 Phone: 419-896-3143
Shear	10 foot x 3/8 inch HTC hydraulic shear 20 hp model 375-10, powered back guage with DRO	Good	\$16,900	Mast Farm Service Michael Yutzky	3585 OH 39, Millersburg, OH 44654 Phone: 330-893-2972 Fax: 330-893-3137 Email: mike@mastfarmservice.com



ITEM	AD DETAILS	CONDITION	PRICE	NAME	CONTACT INFORMATION
Uncoiler	12,000 lb Welty Way, hydraulic	Good	\$5,000	Metal Roofing Supply	6801 Sulphur Springs Rd, Montgomery, PA 17752 Phone: 570-547-6540
Metal Lathe	Colchester 17 x 60, taper attech, steady rest, 3" hole through spindle, tool post, coolant, new way wipers, owners manuel	good	\$8,500	Mill Creek Repair Andrew Peachey	12883 Dachenbach Lane, Mill Creek PA 17060
Planer	Newman 500 4 sided planer, 6 x 14 capacity	Good	\$13,000	Miller's Log Home Supply LLC Jonas Miller	2193 140th Ave, Murray, IA 50174 No Phone
Sander Diesel	Woodmaster 37 inch double drum, lineshaft ready 40 hp Lister HR3 with clutch, crank or battery start	Good Rebuilt	\$1,500 \$2,500	Millers Woodworking Daniel M Miller	W572 County Rd C, Stoddard, WI 54658 No Phone
Forklift	Thompson Crown SC4040 36 volt, 300 hours, 3700 lb	Like New	\$15,900	Nathan Weaver	10790 Pilot Rock Rd, Hopkinsville, KY 42240 Phone: 270-890-0171 Fax: 270-886-9448
Crawler	John Deere 350 B crawler loader	Good	\$12,000	Noah Peachey	3137 S Walker Ramp Rd, Rockville, IN 47872 Phone: 765-344-1585
Consignments Wanted	Woodworking, metalworking, sawmill consignments wanted for Northeast Tool Expo and Auction held on January 15th, 2022	New or Used	Auction	Northeast Auctions John David Shirk	2947 CR 18, Stanley, NY 14561 Phone: 585-526-5964 Fax: 585-526-5964
Power Unit	C13 Cat Power unit, 475 hp with radiator, air cleaner, muffler is optional	Rebuilt	\$27,500	O A Peachey and Sons Lumber Sylvan Peachey	30 E Strack Drive, Myerstown PA 17067 phone: 717-454-6735 phone: 717-926-2413
Finish Pump	Graco-Merkur ES	Excellent	\$750 PPD	Parkman Clock and Gift Eli Detweiler	17930 Madison Rd, Middlefield, OH 44062 Phone: 440-548-9831
Track Skidloader Mini Excavator	2020 Bobcat T590, joystick control, cab heat and air, keyless start, 1500 hours, 2018 Bobcat E35 open cab, long arm, auxillary hydraulic thumb, keyless start 2100 hours	Good Excellent	\$48,000 \$32,000	Paul Troyer	200 Dog Creek Road Cubrun KY 42729 Phone: 270-524-2211 Phone: 270-702-1465
Shaper Shaper	Rockwell 3/4 inch spindle, heavy duty, electric Boice & Crane, 1/2 inch light duty	Good fair	\$950 \$300	Pine Creek Woodworking	W719 Pine Creek Rd, Chili, WI 54420 No Phone
Generator Power Unit Hydraulic Tank Hydraulic Tank Hydraulic Tank Shaper/Sander Table Saw Band Saw Band Saw	Portable light unit with 3 cylinder Kubota diesel, 8020 hours, 6 kw GM671 Detroit with clutch, model 6045C, runs good, has small oil leak Hydraulic tank with pumps or motors, 18 x 48 x 39 2006 RHM fluid power, 100 gallon hydraulic tank with hoses, filters 16 x 24 x 20 hydraulic tank with pump Larick 410 shaper sander, hydraulic drive, 1 1/4 inch spindle 10 inch Delta unisaw model 36-869 with hydraulic motor and 52 inch uni fence 2008 Delta 18 inch bandsaw model 28-682, set up for metal cutting, 2 speed Jet 18 inch bandsaw, model JWBS-18, 1 1/2 hp, 1 phase For pictures see ad on page 331	Good Fair Good Good Excellent Good Good Like New Like New	\$2,500 \$4,500 \$350 \$750 \$450 \$4,000 \$1,000 \$1,800 \$1,750	Pine Valley Bolts	5195 Kinsman Rd, Middlefield, OH 44062 Phone: 440 693 4232 fax: 440 693 4316
Press Brake	Guifil HCS25-63, 69 ton hyd. 100" lng. Quiet running	very good	\$5,000	Praire State Machine Glen Herschberger	71 E CR 100 N, Arthur, IL 61911 Phone: 217-543-3768 Fax: 217-543-3764
Grain Blower Grain Blower Mixer Heat Exchanger Paint Sprayer Grain Leg Distributor Conveyer	Kongskilde TRL 500 grain blower, 460 volt, 50 hp Kongskilde TRL 40 r, 460 volt, 6 inch pipe and elbows, air operated diverted valves, y valves, for Kongskilde system 4 ton paddle feed mixer Exhaust heat exchanger, 12 foot long Hydrostatic painting system, 3 gallon pot 1 65 foot leg, 1500 btu per hour, new belt and buckets 6 inch 6 hole, 6 inch 8 hole, 6 inch 10 hole 9 inch wide chain paddle conveyer with motor	Like New Like New C Good New Fair Good Good New	\$10,000 \$5,000  \$4,000 \$7,000 \$1,500 \$5,000 Best Offer \$10,000 OBO	Quality Feeds LLC	15423 CR20, Middlebury, IN 46540 Phone: 574-238-5048 Fax: 574-825-9433
Shaving Baler Conveyer Diesel	Realtuff hydraulic/electronic compression baler, horizontal, 12 inch x 16 inch chamber 24 foot New Holland portable elevator with web belt, hydraulic 90 hp John Deere	Like New Good Rebuilt	\$22,000 \$1,800 Call	R Little Farm Supply	1144 Spencer Rd, Dillwyn, VA 23936 Phone: 434-390-8642
Track Skid Steer	2019 Kubota SVL 95-2, 95 HP, cab, standard flow, 2 speed, warranty, 530 hr.	Excellent	\$68,950	Raymond Wengerd Jr.	790 Brady Bay Lane, Glenco KY 41046 Phone: 859-613-1470
Diesel Unit Generator Air Compressor Air Tank	3 cylinder Perkins, 13 KW Marelli generator, 5 HP. Quincy air compressor 13 KW Marelli, 2 bearing, with slide mount 15 HP Quincy, model 350L, with slide belt tightner 500 Gallon air tank	Fair Excellent Excellent Excellent	\$1,900 \$950 \$3,500 \$350	Riehl Equipment	66 Walleit Road, Ickesburg, PA 17037 Phone: 717-438-3907
Table Saw Phase Converter	Powermatic 72, Biesemeyer 50 inch fence, hydraulic motor Witmer motor, model 10/30	Excellent Excellent	\$1,995 \$550	Rissler Tools	90 W Church Rd, Stevens, PA 17578 Phone: 717-371-5418
Wanted	Lineshaft drive HVLP turbine sprayer	Write	Write	Riverbend Buggy Parts	10488 Cerulean Rd, Cerulean, KY 42215
Gutter Machine Shear	6 inch New Tech gutter machine in 14 foot trailer, 2-yo Swenson Shear Snap Table Pro	Excellent Excellent	\$12,500 \$9,000 OBO	Southern MD Metal Roofing	12220 Plater Rd, Charlotte Hall, MD 20622 Phone: 301-247-2666
Parts Tumbler Dust Collector	19 inch diameter X 96 inch long parts tumbler with hydraulic motor Dust collector blower with 40 hp electric motor	Very Good Good	\$900 \$2,500	Spark Fabricators, LLC Benjamin	Christiana, PA 17509 Phone: 610-593-6707 x 4

# Machinery Trader

ITEM	AD DETAILS	CONDITION	PRICE	NAME	CONTACT INFORMATION
Forklift	Linde H30 ct showing 2992 hrs. showing rust on the inside	working	\$7,500	Stoney Creek Cabins	24913 Hennepin Place, Bevier, MO 63532 phone: 660-773-5550
Sander	Super Max 36" brush sander	Good	\$3,500		
Tiller	Wolverine 72" 1 hr. of use	Like New	\$2,500		
Welder	Shopmaster LA161553 CC/CV/AC/DC welding power source with 60 series feeder, 220 single phase	Good	\$2,300	Sunny Hollow Hay Equipment Elmer King	628 W Market Street, Gratz PA 17030 Phone: 717-365-3811 Fax: 717-365-3810
Welder	Miller CP300 CV/DC welding power source w/ 2 year old 20 series feeder, 220 3 phase	Good	\$2,600		
Welder	Lincoln CV300 welding power source w/LN10 feeder remote controlled, 220 3 phase	Good	\$2,600		
Welder	Lincoln CV300 welding power source w/LN742H feeder, 220 3 phase	Working	\$1,300		
Welder	Clarke roll-around Mig Welder, 225 amp, 220 single phase	Good	\$900		
Boring Machine	Ritter R46A line boring machine	good	\$1,650	Swartzentruber J	13386 county road 23, Canton MN 55922
Diesel	New Yanmar 2TNE68, 2 cylinder, 13 hp. @ 3600 RPM, with radiator, stub shaft, and panel	New	\$2,650	The Newswangers	1451 Union Grove Rd, East Earl, PA 17519 Phone: 717-445-4274
Diesel	20 hp. Kubota D905 power unit. 3 cylinder, with stub shaft and panel 700 hrs	Good	\$2,800		
Diesel	22 hp. Yanmar 3TNA72, power unit, with radiator, panel and stub shaft	Rebuilt	\$2,950		
Diesel	23 hp 2014 Kohler power unit, KDW1003, 3 cylinder, with panel and stub shaft	Good	\$2,300		
Diesel	28 hp. Yanmar power unit, 3TNE78, 3 cylinder, 1,167 hrs. with radiator, stub shaft and panel	Good	\$3,900		
Diesel	New 32 hp. Cummins A1700 3 cylinder, with radiator	New	\$4,800		
Diesel	New Caterpillar 1.6 liter, 4 cylinder, 33 hp. @ 2800 RPM, with radiator	New	\$4,900		
Diesel	33 hp. Yanmar 3TNE84 3 cylinder, with radiator & panel, Ready to ship	Good	\$3,900		
Diesel	New 36 hp. Yanmar 3TNV88, 3 cylinder, 22 hp. @ 1800 RPM, with radiator	New	\$5,500		
Diesel	47 hp. Yanmar 4TNV88, 4 cylinder, with radiator	Good	\$4,500		
GenSet	30 KW Onan genset. 120/240 volt, 3 phase, 690 hrs., with John Deere. 4 cylinder diesel	Good	\$7,500		
Diesel	55 hp John Deere 3179 power unit, 3 cylinder, with radiator, clutch, and panel	Good	\$5,200		
Diesel	55 hp Yanmar 4TNV84T power unit, 36 hp @ 1800 rpm, 1252 hours, with clutch and panel	Good	\$6,950		
Diesel	70 hp. John Deere 4039D power unit, 520 hrs with clutch and panel	Good	\$6,800		
Diesel	175 hp. Caterpillar 3126, 6 cylinder, bare engine, needs work	Needs Work	\$3,000		
Diesel	Cummins power unit, 6CTA 8.3liter, 237 hp. @ 2100 RPM, with clutch and panel	Good	\$13,900		
Diesel	Cummins QSM11, 6 cylinder, 375 hp. @ 2100 RPM, with frame and radiator, needs rebuilt	Needs Rebuilt	\$7,900		
Tractor	1959 John Deere 730 diesel 2 cylinder tractor, narrow front, new rims & tires, 3 point hitch	Good	\$9,200		
Stub Shafts	2 sizes of stub shafts in stock, quantity discounts	New	\$165		
Diesels	DON'T SEE WHAT YOU NEED, GIVE US A CALL	Call	Call		
Bridge Crane	30 foot X 60 foot X 12 foot, manual clutch, coil car included	good	\$7,500		
Wide Belt Sander	SCMI double head 37"	5 yrs. Old	\$20,000	Turkey Creek Woodworking	13311 N 200 W, Milford, IN 46542 Phone: 1-574-658-3228 Fax: 1-574-658-3140 email: turkeycreekwood@yahoo.com
Planer/sander	NorthTec 37" Planer/Sander	works	\$7,000		
Glue Spreader	Taylor glue spreader	works	\$600		
Moulder	Weinig Profimat 22 IV, 5 head, electric, no motors, ready to convert	Good	\$9,700	Vernon Mullet	11420 Brickyard Rd, Holton, MI 49425 Phone: 641-898-2255
Rollformer	Hercules 2000 rollformer with 2 manual decoilers	Good	\$25,000 OBO	Walter Percy	1451 Route 539, Little Egg Harbor, NJ 08087 Phone: 679-857-3695
Track Skid Steer	2016 Bobcat T590, 66 HP, Cab, Joysticks, Manual Coupler, ONLY 540 Hours.	Excellent	\$46,500	Wendell Shertzer	1082 Letort Road, Conestoga, PA 17516 Phone 717-341-9514
Track Skid Steer	2019 Bobcat T595, 74 HP, Cab, Joysticks, 2 Speed, Reg. Flow Hyd., 770 1-owner hours.	Excellent	\$51,500		
Track Skid Steer	2007 Bobcat T300, 81 HP Kubota, Cab, Foot Controls, Reg. Flow Hyd., 2,400 Hours.	Excellent	\$34,500		
Track Skid Steer	2018 CASE TV380, 90 HP, Cab, 2 Speed, Joysticks, Hi-Flow Hyd., 380 Hours.	Excellent	\$56,500		
Track Skid Steer	2016 CAT 259D, Cab, 74 HP, 2 Speed, Reg. Flow Hydraulics, 725 Hours.	Excellent	\$49,500		
Track Skid Steer	2006 CAT 257B, Cab, 62 HP, 1 Speed, Joysticks, Reg. Flow Hydraulics, Good ASV U/C, 2,600 Hours.	Excellent	\$27,500		
Track Skid Steer	2005 Gehl CTL70, 81 HP, Cab, 2 Speed, Joysticks, Reg. Flow Hydraulics, Good Tracks, 2,580 Hours.	Excellent	\$27,500		
Track Skid Steer	2018 Kubota SVL 75-2, 75 HP, Cab, Joysticks, 2 Speed, Reg. Flow Hyd., 1,360 Hours.	Excellent	\$46,500		
Track Skid Steer	2017 Kubota SVL75-2, 75 HP, Cab, Joysticks, 2 Speed, Reg. Flow Hyd., 1,130 Hours.	Excellent	\$49,500		
Track Skid Steer	2013 New Holland C227, 74 HP, Open ROPS Canopy, 2 Speed Travel, Foot Controls, 2,100 Hours.	Good	\$24,500		
Track Skid Steer	2006 New Holland C185, 78 HP, Cab(no door), 1 Speed, Hand Controls. 2,000 Hours.	Good	\$23,500		
Track Skid Steer	2015 Takeuchi TL12, 110 HP Pre-DEF engine, Cab, 2 Spd., Hi-Flow, 1,600 Hours.	Excellent	\$50,000		
Track Skid Steer	2015 Takeuchi TL12, 110 HP Pre-DEF engine, Cab, 2 Spd., Hi-Flow, Forestry Oil Cooler, 2,050 Hours.	Excellent	\$55,000		
Track Skid Steer	2018 Deere 333G, 100 HP, Cab, 2 Speed, Hyd. Coupler, Pilot Controls, 2,620 Hours.	Excellent	\$49,500		
Track Skid Steer	2012 Deere 323D, 74 HP, Cab, 2 Speed, Power Quick Attach, Hi-Flow, Foot Controls, 1,950 Hours.	Good	\$27,500		
Mini Excavator	2016 Kubota U55-4, 48 HP, Open ROPS Canopy, 860 Hours, Hyd. Thumb, Angle Blade, 12K LB.	Excellent	\$49,500		
Mini Excavator	2019 Deere 35G, 24 HP, Open ROPS Canopy, 1,800 Hours, Aux. Hydraulics.	Excellent	\$32,500		
Mini Excavator	2018 Deere 50G, 36 HP, Cab, 650 Hours, Hyd. Thumb, Straight Blade, 11K LB.	Excellent	\$59,500		
Mini Excavator	2015 JCB 8045 ZTS, 49 HP Pre-emissions Engine, Cab, Aux. Hydraulics, 10,500 LB, 230 Hours!!!	Excellent	\$54,500		
Mini Excavator	2019/2020 Yanmar VIO50-6, 39 HP Yanmar, Open ROPS Canopy, Aux. Hyd., 300 & 500 Hrs., 2 Available	Excellent	\$52,500		
All Wheel Skid Steers	2-Bobcat A300's, 1 w/cab & 2,200 Hours(\$32,500), 1 w/canopy & 4,300 Hours(\$22,500).	Excellent	CALL		
Delivery	Call for shipping quotes. We deliver nationwide!	Call	Call		



ITEM	AD DETAILS	CONDITION	PRICE	NAME	CONTACT INFORMATION
Bandsaw	Grizzly G1019 Wood Bandsaw, air motor and lubricants, ready to work	Good	\$500	Wesley Kauffman	97 Currie Road, Smyrna, ME 04780 Phone: 207-757-7122
VFD Motors	Variable Frequently Drive motors, 2 hp to 10 hp, used for woodworking tools	Great	Call	William Miller	2557 Harrison Rd, Fredericksburg, OH 44627 Phone: 330-600-9380 Email: wmiller081992@gmail.com
Coil Boiler	500,000 BTU Coalgun Stoker Boiler, hopper feed, model 500S, used one year	Excellent	\$9,500	Willis Leid	907 Smoketown Road, Denver, PA 17517 Phone: 717-413-4750
Panel Saw	Safety Speed Panel Saw, 110 volt motor	Good	\$800		
Dowel Machine	Bardolet SL model HA-40 with dowel sanding machine and dies up to 2 inches	Good	CALL	Wisner Woodworking Harvey Miller	5015 S Wisner Ave, Newaygo, MI 49337 Phone: 231-924-5711 Fax: 231-924-6562
Multi-Drill Machine	Model 545 made by Vintage Rd Crafts, all air operated, up to 5 drill setup	Good	CALL		
Profile Sander	Made by Derda Inc, lots of different profiles	Good	\$250		
Table Saw	Delta Rockwell 10 inch unisaw	Good	\$500		
Diesel	Kubota D662 pwr unit clutch & saftey panel 18 hp	Nice	\$2,600	Xcite Repair Co Amos	200 Shirktown Rd, Narvon, PA 17555 Phone: 484-256-9815_9357 Fax: 484-220-3833
Diesel	Kubota D905 pwrunit stubshaft safteypanel 20 hp	Nice	\$2,700		
Diesel	Kubota Z482 pwr unit stub saftey panel 8 hp	Good	\$2,500		
Diesel	Kubota V1305 engine only low hr has starter&alternater	Nice	\$2,100		
Diesel	Kubota V2203 engine only good runner	Good	\$2,050		
	GENSET KUBOTA 6KW 110/220 volt 1phase load tested good	Good	\$3,300		
	Genset perkins 8kw 110/220 volt 1phase load tested	New	\$5,900		
	Generator head belt drive 7.5 kw 1phase 110/220 volt 1800 rpm	New	\$1,650		
	Generator head belt drive 22kw 110/220 volt 1800rpm	New	\$1,750		
	Generator head #4-107 drive 22kw 110/220 volt 1phase	New	\$2,050		
	Generator head #5-106 drive 13kw 110/220 volt 1800 rpm	New	\$1,750		
	Generator head 30 kw 3phase #4-107 drive 110/220 volt	New	\$2,100		
	Murphy saftey control panels	New	Call		
	Parts Kubota engine parts & rebuildkits genuine	New	Call		
	Stubs, stub shafts all sizes	New	Call		
Diesel	Cummins 5.9 T.A. fresh rebuild has clutch-control panel 195 hp	Nice	\$8,800		
Diesel	Yanmar 3TNA72UJ engine only 1800 hrs runs good	Good	\$2,050		
Diesel	John Deere 5030 Turbo pwr unit clutch & panel 75hp low hr	Nice	\$7,300		
Diesel	Yanmar 4 TNV86 engine only good clean runner	Good	\$1,900		
Turret Lathe	Midland Universal 21 inch swing, lots of tooling, made in Chicago	Good	\$3,000	Yoder Machining and Repair/Floyd Yoder	2460E 500 S, Wolcotville, IN 46795 Phone: 260-854-2606 x 2
Unisaw	10" Delta Unisaws w/ unifence	Reconditioned	\$900	Yoder Sales	1805 270th Street, Redding IA 50860
Jointer	Jointers w/ Byrd Heads	Reconditioned	Write		
Shaper	Powermatic model 26 Shapers, 1 1/4" Spindles	Reconditioned	\$1,200		
Bandsaw	Delta 14"-20" Bandsaws	Reconditioned	Write		
Line Bore	13 Hole Line Bore, Delta	Like New	\$1,350		
Hinge Press	Grass - Hinge Press - Air operated	Reconditioned	\$375		
Heads	Byrd Heads for Planers, Jointers, Shapers	Reconditioned	Write		
Freight	Reasonable Freight Rates	Write	Write		
Resaw	2 head Kent, electric, no return	Good	\$12,500 OMO	Yoder Sawmill Toby Yoder	10564 Hwy Y, Madison, MO 65283 Phone: 660-291-5460 or 3014
Diesel	6068 John Deere Powertech, approx 500 hours on rebuilt, new injectors and turbo	Good	\$9,000 OMO		
Edger	4 X 36 inch Meadows Deluxe, 4 stationary blades	Good	\$4,000 OMO		
Clutches	3 = #3 double plated	Good	\$600 each		
Clamping Table	Ritter 3 x 6 door clamping table with 4 air clamps	Good	\$2,400 OBO	Yoder Woodworking	8105 W 450 N, Shipshewana, IN 46565
Generator	Lima Mac 40 KW belt drive generator with 4 almost new belts	Good	\$2,000 OBO	Freeman L Yoder	Phone: 260-768-7327 x 1 Fax: 260-768-4371
Logging Carts	Winch cart, 7 x 48 wheels, D ring harness, new carts available with winch, call or write for brochures	Used	\$4,750	Yoder's Repair/David Yoder	2414 St Hwy 18, Adamsville, PA 16110 Phone: 330-357-7388
Tractor	Ford 8N tractor for sale, great paint, left side brake is sticky	Great	\$3,200		Phone: 717-210-9943
Welder Wanted	Miller Trailblazer 325, mig and tig attachments				Phone: 260-692-9013 leave message
Air Compressors	Quincy, 1 thru 25 hp, we specialize in compressed air	New, Used, Rebuilt	CALL	Stoltzfus Compressor Service	10536 Pembroke Rd, Pembroke, KY 42266, Phone: 270 475 9635 7:00 - 7:15 PM CT

# Machinery Trader

ITEM	AD DETAILS	CONDITION	PRICE	NAME	CONTACT INFORMATION
Clamp Carrier	Taylor Panel flattener, 40 section, 120 clamps, 32"x100" clamping area, includes self contained hyd. pack	Excellent	\$17,500		
NorthField Planer	Model 7 HH with Northfields carbide tipped spiral head, 24"x9" segmented infeed rollers, bottom rollers are powered	Excellent	\$6,950		
Centauro Bandsaw	Classico 900, can rip up to 20" x 34" up to 1 1/2 inch bands	Good	\$3,950		
Clamping Table	Unique 4'x 8' with pneumatic clamps, very clean	Like New	\$4,950		
Sliding Table Saw	Casadei KS-3000 10' slider, complete with extra accessories	Good	\$4,950		
Shaper	double spindle Baxter Witney 1 1/4 spindles	Good	\$2,700		
Jointer	Jet 8"x 66" with new spiral head lineshaft	Good	\$1,450		
Tenoner	Rustic log Tenoner, has dust head and chip hopper, lineshaft	Like New	\$4,950		
Horizontal Borer	Doucet 8' table, multiple spindles, also 2 4' models available	Good	\$5,500		
Horizontal Borer	Grizzly G4185 year 2016 comes with 2 spindle head & 3 spindle head	Like New	\$2,500		
Line Borer	Ritte R-42-3 double row line borer, drills from the bottom	Excellent	\$4,000		
Over arm Router	Onsrud Model RO-117	Good	\$900		
Shaper	Grizzly G1035 3/4" spindle with small power feed	Good	\$550		
Dust Collector	Grizzly G0441 dust collector, lineshaft ready	Good	\$1,500		
Chopsaw	Dewalt 12" with 0x air motor	Like New	\$500		
Job site Table Saw	Dewalt 10" with air motor	Good	\$750		
Power Feed	4 roll staff power feed, 4 speed	Good	\$900		
Woodworking	I have access to a 15,000 square foot warehouse stocked with used machinery	Good	call		
Framing Table	Stonewood 4 foot x 8 foot, pneumatic hold downs	Brand New	\$3,400		
Band Saw	American, 30 inch band wheels very heavy cast iron	Very Good	\$1,800		
Stroke Sander	Grizzly model G5394, year 2008	Good	\$1,800		
Pocket Hole Machine	Ritter R200-T single spindle	Excellent	\$1,950		
Shaper	Invicta Delta TI 14, 1 1/4 spindle with good fence, broken petal, 43 x 35 table, 7.5 hp	Good	\$3,250		
Shaper	Chang Iron model CMP 2, 3/4 inch spindle with fence	Good	\$1,100		
Shaper	Double spindle shaper with fences, 1 1/4 spindles, heavy duty machine, 6.6 hp motors	Good	\$2,800		
Table Saw	Delta Rockwell, 12 - 14 inch, heavy duty, very clean, older style fence	Call	\$1,200		
Dust Collector	Coral, 2 hp, portable, 2 bag	Good	\$500	Menno Hostetler	3155 Davis Rd, Seymour, IA 52590 Phone: 641-898-2248
Edge Sander	Rodgers 6 inch x 166 inch, single sided, 49 inch Platen, heavy duty	Good	\$1,800		
Jointer	6 inch x 41 inch Cal Hawk, 1 hp, 110/220 volt, 1 phase	Good	\$400		
Narrow Belt Sander	4 head 9 inch wide sander, made to sand flooring as it exits the moulder, air tracking	Like New	\$10,000 OBO		
Dust Collector	Coral 3 bag portable, 220/440 volt, 3 phase, 3 hp	Good	\$750		
Inverted Router	Delta/Onsrud, 20 inch throat, table size, 24 inch x 35 inch, Porter Cable router	Good	\$1,500		
Chair Leveler	Chair leveler with several size stands for a variety of chairs, electric	Good	\$500		
Spindle Sander	Max vertical oscillating sander, tilting table, 115 volt, 1 phase	Very Nice	\$1,200		
Table Saw	Powermatic 66 10 inch cabinet saw, 5 hp, 230/460 volt, 3 phase, Accu fence, 53 inch rail	Like New	\$2,500		
Upcut Saw	Whirlwind 212L 18 inch blade, 10 hp, 230/460 volt, 3 phase	Good	\$1,800		
Jointer	Grizzly, 8 inch x 75 inch, model G 0593, spiral cutter head, 2 hp, 110/220 volt, 1 phase	Like New	\$1,800		
Scroll Saw	Delta scroll saw with stand, model 40-601, 115 volt, 1 phase	Very Good	\$400		
Pocket Hole Machine	Castle model TSM-20, has 2 Porter Cable routers, 115 volt, 1 phase	Call	\$1,800		
Dust Collector	Powermatic model 075, 2 bag portable, 3 hp, 230/460 volt, 3 phase, 3 available	Call	\$750		
Wide Belt Sander	36 inch AEM with finishing platen head, infeed and outfeed rollers, light duty	Fair	\$2,000		
Wide Belt Sander	AEM/SCMI 43 inch double head, model CL-110 floating bed	Good	\$10,000		
Line Borer	Castle 30 spindle line boring machine, model LB-30, 230 volt, 1 phase, drills from the bottom	Good	\$2,000		
Dust Blower	Seco dust blower, 5 inch inlet, 5 inch outlet, 18 inch diameter, 2 hp, 110/220 volt, 1 phase,	Good	\$250		
Mortiser	Delta Hollow chisel mortizer, model 14-650, no bits, 120 volt, 1 phase	Good	\$400		
Power Feed	Two 4 roll and one 3 roll power feeds in good condition	Good	\$800 - \$1,000		
Blush Eliminator	Gemini blush eliminator aerosol cans, 23 cans LA 100, price includes shipping	New	\$150		
Hydraulic Unit	15 hp 230/460 volt, 3 phase, 1750 rpm, Thermal 350 degree heat exchanger	Good	\$1,000		
Hydraulic Unit	10 hp hydraulic unit, 230/460 volt, 3 phase, looks to be alright	Good	\$400		
Blower	Dayton 8 inch x 22 inch diameter, 13 1/2 inch bottom flange inlet and outlet, looks brand new	Very Good	\$700		
Shaper	North-Tec NT 525-73, 1 1/4 spindle, 3 phase, 230/460 volt, no fence, 4 speed, 5 hp	Good	\$1,900		
Shaper	North-Tec NT 101-53, 1 1/4 spindle, 5 hp, 230/460 volt, 3 phase with fence, 2 speed	Good	\$2,000		
Shaper	Invicta Delta RS 15, 1 1/4 spindle, 7.5 hp, 230/460 volt, 3 phase, heavy duty, cast iron base, no fence, 5 speed	Good	\$2,200		



# Machinery Trader

ITEM	AD DETAILS	CONDITION	PRICE	NAME	CONTACT INFORMATION
Shaper	Walker Turner 3/4 inch spindle, 230 volt, 3 phase, micro adjustment fence, 2 speed	Good	\$1,000		
Shaper	Delta, heavy duty model 43-791 5 speed, 7.5 hp, 220/440 volt, 3 phase, 3/4 inch spindle	Very Nice	\$2,000		
Table Saw	Master Machinery, 10 inch Biesemeyer, 53 inch rail, 2 hp, 110/220 volt, 1 phase, good	Good	\$1,300		
Table Saw	Delta Rockwell Biesemeyer 53 inch rail, 3 hp, 230/460 volt, 3 phase	Good	\$1,200		
Profile Sander	Larick tilting arbor brush sander, model 360V, works good for cabinet doors	Good	\$1,000		
Planer	Sears Craftsman 12 inch wide planer, 2 hp, 115/230 volt, 1 phase	Like New	\$700		
Planer	Geeteck 15 inch planer, 3 hp, 230 volt, 1 phase, identical to Grizzly	Very Good	\$1,100		
Band Saw	Powermatic 36 inch model BUU900, 7.5 hp, 230/460 volt, 3 phase, heavy duty machine	Good	\$3,950		
Shape and Sand	SCMI center machine, looks good but I don't know a lot about it, 9 hp, 220/440 volt, 3 phase	Call	\$2,500 OBO		
Straight Line Rip	Diehl 18 inch model 75, chain and race look good, hold down rollers need new bearings	Fair	\$1,200		
Clamp Rack	Taylor 12 foot model 79A, 29 clamps, 16 are 32 inch and 13 are 40 inch	Very Good	\$3,600	Menno Hostetler	3155 Davis Rd, Seymour, IA 52590 Phone: 641-898-2248
Band Saw	American Sawmill Machinery Co, 28 inch band saw, 3 hp, 220/440 volt, 3 phase	Good	\$1,500		
Horizontal Borer	Newton 2 spindle dowel boring machine, perfect for lineshaft shops	Good	\$500		
Table Saw	Delta 10 inch unisaw model 36-953, Biesemeyer T-square fence and 51 inch rail, 3 hp, 230 volt, 1 phase	Like New	\$2,000		
Scroll Saw	Rockwell/Delta 24 inch with stand, 3/4 hp, 115 volt, 1 phase	Good	\$500		
Jointer	12 inch Oliver model 116-B, 5 hp, 3 phase, bed is 99 inches long	Very Clean	\$3,600		
Roller Conveyer	2 12 inch x 96 inch roller conveyers with legs on one end	Very Good	\$150 each		
Line Borer	Ayen 21 spindle line boring machine, model LRB-3221, drills from the top, 3 phase	Good	\$2,000		
Line Borer	Macron 46 spindle line boring machine, model M6000C, drills from the bottom, 2 available	Good	\$2,000		
Line Borer	Ritter, 19 spindle line boring machine, model R-19F, 2 hp, 230/460 volt, 3 phase	Good	\$2,000		

PLEASE FILL OUT THIS FORM (PRINT CLEARLY) INCLUDE PAYMENT AND SUBMIT TO  
**MACHINERY TRADER**  
 Please send completed submission form with payment to — PCBE, P.O. Box 520, Millersburg, PA 17061  
 Fax to: 717-427-1602 or Call: 717-362-1118 ext 2 or Email to: MT@plaincommunities.com

ITEM	DESCRIPTION	CONDITION	PRICE
	<b>13 WORDS MAXIMUM IN THIS AREA</b>		

✓ Check the boxes below to indicate contact information you DO NOT want printed in Machinery Trader

HAVE ALL MACHINERY TRADER ADS SUBMITTED BY THE 14TH

THIS INFORMATION WILL BE PRINTED FOR CONTACT		\$18.00 PER LINE UP TO THREE LINES, FOUR OR MORE LINES \$15.00 EACH	
<input type="checkbox"/> Business Name (optional)	Number of Lines _____ x \$ _____ =		
<input type="checkbox"/> Name	Number of Months x _____		
<input type="checkbox"/> Address	TOTAL DUE		
<b>CREDIT CARD INFORMATION</b>			
<input type="checkbox"/> City State Zip	Account No. _____		
<input type="checkbox"/> Phone	Expiration Date: ____/____/____	3 Digit Security No. _____	
<input type="checkbox"/> Fax	Card Holder: _____		
<input type="checkbox"/> Email	Signature: _____	Zip: _____	

<b>05 DOOSAN G30P-3</b> <b>\$14,500<sup>00</sup></b>  <ul style="list-style-type: none"> <li>• 6,000 lb. Capacity</li> <li>• 3,924 hrs</li> <li>• 3 Stage</li> <li>• Sideshift</li> <li>• Traction Tires</li> <li>• Propane Eng.</li> </ul>	<b>05 YALE GLP110</b> <b>\$15,000<sup>00</sup></b>  <ul style="list-style-type: none"> <li>• 11,000 lb. capacity</li> <li>• 10,032 hrs</li> <li>• 3 stage</li> <li>• 8' sideshift</li> <li>• dual tires</li> <li>• propane eng.</li> </ul>	<b>2000 HYSTER H110XM</b> <b>\$10,500<sup>00</sup></b>  <ul style="list-style-type: none"> <li>• 11,000 lb. capacity</li> <li>• 13,167 hrs</li> <li>• 2 stage</li> <li>• sideshift</li> <li>• dual tires</li> <li>• diesel eng</li> </ul>	<b>HYSTER H40XL</b> <b>\$7,500<sup>00</sup></b>  <ul style="list-style-type: none"> <li>• 4,000 lb. capacity</li> <li>• 4,685 hrs</li> <li>• 3 stage</li> <li>• no sideshift</li> <li>• air tires</li> <li>• diesel eng.</li> </ul>
<b>05 TOYOTA 7FGAU50</b> <b>\$26,000<sup>00</sup></b> <ul style="list-style-type: none"> <li>• 11,000 lb. capacity</li> <li>• 4,039 hrs</li> <li>• 3 stage</li> <li>• Sideshift</li> <li>• new dual tires</li> <li>• propane eng.</li> </ul> 	<b>TOYOTA 7FGAU55</b> <b>\$18,750<sup>00</sup></b> <ul style="list-style-type: none"> <li>• 12,000 lb. capacity</li> <li>• 6,894 hrs</li> <li>• 3 stage</li> <li>• sideshift</li> <li>• forkpositioner</li> <li>• traction tires</li> <li>• propane eng</li> </ul> 	<b>TOYOTA 42-6FGCU15</b> <b>\$8,200<sup>00</sup></b> <ul style="list-style-type: none"> <li>• 3,000 lb. capacity</li> <li>• 11,672 hrs</li> <li>• 3 stage</li> <li>• sideshift</li> <li>• cushion tires</li> <li>• propane eng.</li> </ul> 	<b>PETTIBONE 104-C</b> <b>\$8,000<sup>00</sup></b> <ul style="list-style-type: none"> <li>• 10,000 lb. capacity</li> <li>• 3,714 hrs</li> <li>• 4 wheel drive</li> <li>• 4 wheel steer</li> <li>• 4' 6" forks</li> <li>• detroit diesel</li> </ul> 
<b>FORKLIFTS ARE FULLY SERVICED!</b>			<b>WE CAN DELIVER!</b>

Coming in:  
02 Hyster S65XM 7,000 hrs.  
05 Toyota FGU25 5,676 hrs.

Financing Available

Lester Burkholder • 297 Hurst Road, Ephrata, PA 17522

phone: 717-445-4890 fax: 717-445-7690



**DON'T SEE WHAT YOU NEED?**

**GIVE US A CALL**

**717-656-4853**

540 S. Fairmount Rd.  
Ephrata, PA 17522

**2019 DOOSAN GENSET**



Open Skid 4045, JohnDeere  
POWERTECH Diesel, New Unused  
75kw Prime

PRICE \$16,500<sup>00</sup>

**NEW 2020 MODEL 28KW DELTA GENSET**

28kw 1 phase Continuous Duty. [24hr. a Day]  
Featuring a Heavy Duty Perkins Diesel; paired  
with a Leroy-Somers GenHead 250Gal. Base  
Diesel Fuel Tank;  
sound attenuated  
enclosure.



PRICE \$14,500<sup>00</sup>

**D200P3 OLYMPIAN**

200kw, Year 2006, 11,500hrs



PRICE \$10,900<sup>00</sup>

**2005 100KW KOHLER**

100kw 3 phase; 80kw 1 phase 6.8L  
John Deere Power Tech Diesel 400hrs



PRICE \$14,500<sup>00</sup>

**2021 16kw YANMAR GENSET**

**NEW** 1 phase or 3 phase, Automatic Start Yanmar Diesel with No  
emission! Perfect to run your fans and charge your battery  
pack. Rugged enough to run your shop every day. Efficient  
enough to run your Coffee Perker!

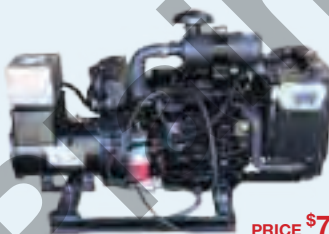

PRICE \$7,950<sup>00</sup>

**600KW CUMMINS ONAN**

765hrs



PRICE \$29,500<sup>00</sup>

**2014 G180 WACKER NEUSEN**

143kw Super Quite 2200 hours Qsb7  
Cummins Diesel Like New!

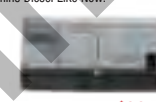

PRICE \$29,500<sup>00</sup>

**2001 Detroit Genset**

220 kw Series 50 Detroit Genset Enclosed  
Diesel



PRICE \$16,500<sup>00</sup>

**1999 ONAN 300kw**

Onan, 300kw, used, 602hrs. Excellent  
condition. Hospital take out



PRICE \$35,000<sup>00</sup>

**20KW KOHLER PROPANE/NAT. GAS**

2.3L Ford Engine, 20kw 1 phase or 3 phase,  
3100hrs



PRICE \$4,500<sup>00</sup>

**Stationary Enclosed Diesel Genersets**

- 30kw Onan 1140hrs Base fuel tank Cummins A-series Diesel.....\$4,500
- 34kw Kohler Enclosed John Deere Diesel 188hrs.....\$8,200
- 1994 40kw Kohler JD Diesel 940hrs.....\$7,500
- 75kw Olympian Perkins Diesel Base Fuel Tank 6000hrs.....\$8,900
- 75kw 2007 Katolight 4045PT JohnDeere Diesel.....\$12,500
- 80kw Cummins Onan 750 Hours 6BT5.9L Cummins Diesel.....\$11,500
- 1998 100kw Cummins 67 1 phase 5.9L Cummins Diesel Super quite! 5000hrs.....\$12,000
- 100kw 2005 Kohler 407hrs Enclosed Super Quite Nice!.....\$12,500
- 100kw 3116 Caterpillar Genset with base Fuel Tank 900hrs.....\$12,500
- 2000 125kw Cummins 6CT8.3-G2 Cummins Diesel Super Quite! 2500hrs.....\$14,500
- 2003 125kw Kohler 6.81 JD Power/Tech.....\$14,500
- 1999 300kw Cummins Onan 855 Big Cam Cummins Diesel Sound attenuated walk-in Enclosure, Super Quite!!! 600hrs Very Nice!.....\$35,000
- 220kw Series 50 Detroit Enclosed NoTank.....\$16,500
- 2014 G180 Wacker Neusen 2200 hours Super Quite, 143kw Base Fuel tank Cummins Diesel.....\$29,500
- 2010 600kw Hi-Power Low Hours Super Quite Volvo Diesel.....\$69,500

**Stationary Open Skid Diesel Genersets**

- 2021 16kw Yanmar-Stamford Genset Quality! Long Life! Fuel Efficient! NEW!.....\$7,950
- (2)2019 75kw Continuous DOOSAN 4045 JD PowerTech NEW! UNUSED No emissions.....\$16,500
- 80kw Kohler JohnDeere Diesel 3,000hrs Nice original.....\$8,900
- 125kw Generac Marathon Head Nice straight Machine.....\$7,500
- 180kw Cat 3306T Caterpillar Diesel 7000hrs.....\$9,500
- 200kw Cummins genset 1600hrs Cummins 855 Diesel.....\$12,500
- 2006 200kw Olympian D200P3 11500hrs 1300 Series Perkins Diesel.....\$10,900
- 300kw Kohler Detroit diesel needs work.....\$6,500
- 600kw Cummins Onan VTA28 Cummins Diesel 765hrs good machine.....\$29,000
- 670kw Marathon/16V92 Detroit Diesel 400hrs Clean Original Machine.....\$26,000
- 2011 60 kw Cummins Onan 215 hours Like New.....\$10,500
- 85 kw Cat GenSet 3304 Cat Diesel Shows 858 Hours Right out of service.....\$8,900
- 80 kw Perkins GenSet 1004Turbo charged Perkins Diesel 3800 Hours.....\$9,500
- 2005 500kw Cat 3456 GenSet.....\$35,900

**Stationary Enclosed LP/Nat Gas Genersets**

- 2000 19kw Spectrum 630hrs Original take-out unit 2.31 Ford, Autostart.....\$5,200
- 2007 Generac 120/208.....\$5,200
- 60kw Generac.....\$5,200
- 200kw Kohler series 60 Detroit, 166hrs.....\$21,500
- 60kw Cummins Onan 670 Hours 5. 71 Ford 40kw lphase.....\$7,500
- 2006 60kw Cummins Unit 40kw 1 Phase PC2100 Controls.6.81 Ford.....\$8,900

**Stationary Open Skid LP/Nat Gas**

- 20kw Cummins Onan 430 hours Clean Original Unit 2.31 Ford, Autostart.....\$4,500
- 20kw Cummins Onan 430 hours Clean Original Unit 2.31 Ford, Autostart.....\$4,500
- 75kw Cummins Onan 800 hours.....\$8,500
- 85kw Katolight 418hrs, 65kw 1phase 7.5L Ford Engine Electronic Governor.....\$8,500
- 125kw Industrial Cummins Eng. 706hrs.....\$10,500

**Towable Diesel Generators**

- 1994 40kw Kohler 935hrs JD Diesel 37kw 1 phase.....\$7,500
- 56kw 2005 MQ Power, 9550hrs JD diesel.....\$9,500
- 56kw 2017 QAS70 Atlas Copco Tier4 Flex JohnDeere Diesel 4075hrs.....\$29,000
- 143 Kw Wacker Neusen 2200 hours.....\$29,500

**Miscellaneous**

- D38 Cat Dozer 6 wat blade.....\$25,000
- Radiator for series 60 Detroit side by side.....\$3,000
- 250cfm IngersollRand Air 500 hours Towbehind Isuzu Diesel.....\$9,900

**Engines**

- 280hp 8.3 Cummins 5000hrs Nice clean engine.....\$7,500
- 215hp 8.31 Cummins 5200hrs Nice Clean Engine.....\$6,800
- 5.91 Cummins Various options.....\$6,000-\$6,500
- Perkins 403F New 13hp @1800 6 available.....\$1,800
- 4TNV106 Yanmar New 90hp.....\$6,900
- Cat 3412, 1100hrs, 800hp.....Call
- 7.4 GM LP/Nat electronic gov.....\$2,900
- 11040 Perkins 2007 tier 3 125hp, 11000hrs rod to flywheel.....\$4,800
- 11040 Perkins 2011 tier 3 125hp, 7000hrs rod to flywheel.....\$5,800
- 3126 Cat 2004 tier 3 300hp rod to flywheel 11000hrs.....\$5,500
- C10 Cat 2001 305hp, runs good.....\$6,700
- Series 40 Detroit 300hp, shows 4800hrs, 2004.....\$4,300
- NEW 190HP IVECO FPT EnginesAvailable Now! Mechanical Tier 3 NO EMISSIONS 6.7LTurbochargedand aftercooled with radiator and aircleaner.....Call For Special Pricing

**New Transfer Switches In-Stock**

- 200 AMP 1 PHASE 120/240vac Outdoor.....\$495
- 200 AMP IPHASE 120/240VAC Automatic Outdoor.....\$3,095
- 400 AMP IPHASE 120/240VAC Automatic Outdoor.....\$2,995

**Generator Heads**

- 600kw Stamford Good used.....\$4,900
- 500kw Marathon 277/480 Vac 3 phase.....\$3,500
- 300kw Stamford 400hrs #1/14 drive.....\$2,900
- 180kw Lima 800 hrs.....\$1,800
- 175kw Marathon 1300hrs #3/11.5 Drive.....\$2,500
- 115kw Marathon #3/11.5 Drive NEW!.....\$2,500
- 105kw LeroySomers NEW! 12 lead.....\$3,200
- 97kw LeroySomers NEW! 12 lead.....\$2,900
- 71kw LeroySomers NEW! 12 lead.....\$2,500
- 60K Lima Generator 700hrs.....\$1,000
- 50kw Stamford 2 Bearing Belt drive NEW!.....\$2,900
- 2021 27kw Stamford belt drive generator NEW!.....\$2,400

**Power Units**

- New 83hp @2200rpm Yanmar Power Unit 4TNV106 Complete Power unit.....\$9,800
- 2007 125hp Perkins Common Rail 11000hrs Complete Power unit.....\$5,800
- 215-HP C6TA8.3 CUMMINS Mechanical Complete Power unit 5000hrs.....\$10,500
- 200hp 6BTA5.9 Cummins Complete Power Unit 4500hrs.....\$8,500
- 280+hp C6TAA8.3 CUMMINS Mechanical Complete Power Unit 5000hrs.....\$12,500
- DETROIT POWER!! 353 Detroit Diesel 65HP Good Runner!!! Radiator, Aircleaner, and Controls!.....\$5,500
- 2011 300HP 6068T JohnDeere Diesel Common Rail 11,800hrs Radiator, Air Cleaner, And controls!.....\$7,500
- 75 HP 4039D JohnDeere Diesel 1579hrs Radiator, Muffler, Aircleaner and Controls.....\$5,500
- 150 HP JohnDeere PowerUnit 1400hrs Radiator, Muffler, Aircleaner, and Controls.....\$7,500

**SPECIALIZING IN  
QUALITY, LOW HOUR  
GENERATORS**

Sales • Service • Rentals We Ship Nationwide

**717-656-4853 | Fax: 717-654-8131**



# SKIDLOADER SALES

OPEN 8AM TO 5PM MON THRU FRI  
- SAT 8AM TO 12PM EST

WE DELIVER NATION WIDE | CALL FOR INVENTORY UPDATE

• **2014 Bobcat T770**, Cab, 2 spd, Joysticks, 1,324 Hrs, High Flow, Forestry Package, Power Detach Pre - Def, 92 hp, Load Rating 3,100 lbs. ....  
**\$56,000.00**



• **2018 Kubota, SVL 75-2**, 1 Owner, 1,330 hrs, 2 spd, 74 hp, Joysticks, Load Rating 2,300 lbs. ....  
**\$37,500.00**



• **2015 Kubota, SVL75-2** Cab, 2 spd, Hydraulic Detach, Joysticks, 74 hp, 3,438 hrs, Load Rating 2,300 lbs. ....  
**\$35,500.00**



• **2015 Bobcat T590**, ACS Controls, Selectable Hand or Foot Control, 2,466 hrs, 66 hp, Self Leveling, Load Rating 2,000 lbs. ....  
**\$27,500.00**



• **2015 Cat 259D**, 2 spd, Joysticks, 74 hp, 3,523 hrs, Load Rating 2,030 lbs. ....  
**\$30,900.00**



• **2017 JD 331G**, Cab, 2 spd, Joysticks, 2,727 hrs, 91 hp, Keyless Start, Power Detach, Rear Weights, Load Rating 3,100 lbs. ....  
**\$46,500.00**



• **2017 Takeuchi TL 12V2**, Cab, 2 spd, Joysticks, 638 hrs, High Flow Power Detach, 111 hp, Load Rating 4,105 lbs. ....  
**\$59,000.00**



• **2015 Cat 236D**, Cab, 2,802 hrs, Joysticks, 73 hp, Load Rating 2,150 lb. ....  
**\$28,500.00**



• **2016 Takeuchi TL 10V2**, Cab, 2 spd, Joysticks, 1,554 hrs, Power Detach, 74 hp, Load Rating 2,533 lbs. ....  
**\$43,500.00**



• **2004 ASVRC 60**, Cab, No Door, 730 hrs, Joysticks, 60 hp Perkins, Load Rating 1,330 lbs. ....  
**\$23,500.00**



## TIRES • BUCKETS • FORKS

Set of 4 Tires—12x16.5 6 rims .....\$975  
10x16.5 6 rims .....\$875  
Buckets—72" .....\$800  
78" .....\$825  
84" .....\$850  
Forks—48" 4,000 lbs. ....\$695  
48" 5,500 lbs. ....\$850



• **New Wildcat Brushcutters**, Triple Blades, Standard Flow Hydraulics, 78" .....  
**\$3,950.00**  
70" .....  
**\$3,700.00**



• **2004 NH LS170**, Cab, 2,850 hrs, Foot Controls, 52 hp, Power Detach, Load Rating 1,700 lbs. ....  
**\$17,800.00**



• **2009 NHL 170**, Foot Controls, 3,274 hrs, 52 hp, Load Rating 1,765 lbs. ....  
**\$16,800.00**



• **2005 Yanmar Vio 27 Excavator**, 4,098 hrs, 2 spd, Pattern Select, Hydraulic Thumb, Hydraulic Quicktach, 18" Bucket, 22 hp, Weight 6,400 lbs. ....  
**\$17,800.00**



APPROXIMATE MID-WEST FREIGHT COST \$550.00 TO \$850.00

CALL FOR FINANCING: 570-458-6785

Burkholder Skid Loader Sales LLC – 649 N. Railroad Avenue, New Holland, PA 17557 | phone: 717-354-5186 or 717-355-5186

# LARK

## CASTING, LLC

2959 TR 163 · Baltic OH 43804  
Ph: 330.600.7327 · Fax: 330.897.3153

Bar Stool Seat Ring



Bar Stool Seat



Spreader Bar 1"

Length 36" every 2" to 72"



# CUSTOM

Aluminum Parts & Castings

## ALUMINUM LEGS

#28p-19

28" Pedestal Base

Height 28"

Dia. Top 18 1/2"

Dia. Bottom 24"

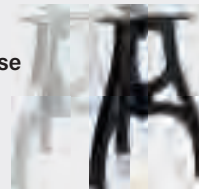

#16-19 16"

H Bench Leg

Height 16"

Width 13 1/2"



#16-18

16" Bench Leg

Height 16"

Top 12"

Bottom 15"



#28-18

Table Leg

Height 28"

Top 18"

Bottom 24"



#28-19

28" H Table Leg

Height 28"

Width 29"





***Lasting solutions for your... Soil. Plants. Livestock.***



For Soil and Plants, our most popular products  
**•Plant-Sure™ • Regenerex™ • Cal-Sentials™**

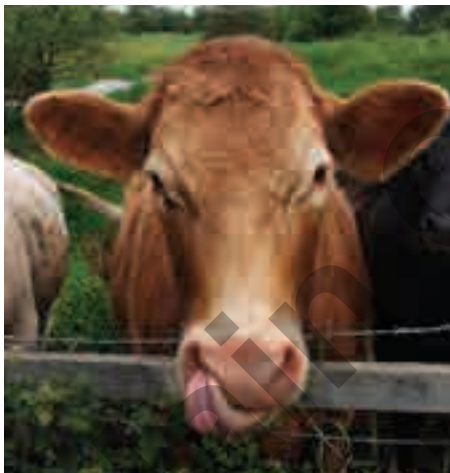

Moldy Feed?  
 Mineral Deficiencies?  
**Desert Dyna-Min™**  
 and a full line of free choice minerals  
 for healthier, more productive livestock



Stressed Animals?  
**Aqua-Nox™**  
 Water additive for all livestock



Lame Horses? You Need  
**Limber Res-Q™**  
 Supplement for healthy joints  
 and muscle

**Questions:**  
**Call 1.877.393.4484**  
**Explore all our products:**  
**[www.agri-dynamics.com](http://www.agri-dynamics.com)**

**Oregon Ag**  
 Lititz, PA  
 717-656-0067

**Zeiset Ag Consulting  
 & Sales**  
 Millersburg, PA  
 717-433-7702

**Green Heron Growers**  
 Panama, NY  
 716-720-3695

**Mark Burley**  
 Newark, NY  
 315-946-6061

**Martins Agri**  
 Service Moravia,  
 NY  
 315-730-6044

**Zach Gunnink**  
 Gibbon, MN  
 507-327-6920

**Hiland Supply**  
 Millersburg, OH  
 330-893-4724

**F.D. Miller Feed  
 & Supply**  
 Shipshewana, IN  
 260-768-4837



Pricing subject to change. Please call to check pricing during current market conditions

# Hamilton Tool and Supply Company

401 Seventh Avenue, Beaver Falls, PA 15010

phone: 1-800-783-4766 | fax: 724-847-1808 | email: hts401@yahoo.com

38 Years Service to the Plain Communities - 1983-2021

## Home of Accura Machinery

Importers, Pickers, Peddlers, Traders, Recyclers searching for problems to solve! We turn your knowledge into power with all the tools we have at our disposal! "Why do people drive for days to get here? It is not because we give bad directions!" Parts, Blades, Cutters! Free Catalog, Tours, Advice. Trade-Ins gladly accepted. Discounts without Electrics.

### Accura 24" Industrial Planers "A Proven Work Horse"

**With Carbide Spiral Heads**  
 01124 VHTS 10hp 3 Phase.....\$6,888.86  
 01124 VHBS w/o Electrics.....\$6,262.62  
 01124 VHS Shp 1 Phase.....\$6,888.86

**Straight Knife**  
 01124 VB w/o Electrics.....\$4,242.42



**20" Planers in Stock**  
**Straight Knife 4 Knife Shp**.....\$3,194.00

**Carbide Helical Head Shp**.....\$3,999.99

**ORDER NOW TO BEAT THE NEXT INCREASE SOLD OUT TAKING ORDERS FOR LATE DECEMBER**

### Super Duty Cabinet Table Saw

50" Fence Capacity with Riving Knife  
 10" Left Tilt or 12" Right Tilt

**12" Right Tilt Models**

- Model 02212 saw only no sliding table 5 HP 220 volt single phase.....\$2,188.12
- Model 02212B saw only without electrics for line shaft/hydraulic/air use.....\$1,999.99
- Model 02212R 5 hp with sliding table.....\$3,132.33
- Model 02212RB no electrics, with sliding table for line shaft/hydraulic/air.....\$2,777.72

**LEFT TILT 10" MODELS ALSO AVAILABLE WITH OR WITHOUT SLIDING TABLES**

- Model 02210L 10" 3 hp.....\$1,699.61
- Model 02210LB 10" without electric.....\$1,577.51
- Model 02210LR 10" 3 hp with 4 x 8 sliding table.....\$2,599.52
- Model 02210LRB 10" no electrics with 4 x 8 sliding table.....\$2,425.26



### Accura Super Duty 1 1/4 Spindle Wood Shapers

**SPECIFICATIONS:** Include 1 1/4" and 3/4" spindles, 35" x 28" table, 5 1/2" capacity under the nut on the 1 1/4" spindle, 4 speeds - 3600, 5100, 8000 and 10000 RPM, 5 7/8" MAX cutter size, spindle travel 3 1/4", 4" dust chute, adjustable fence. 1 1/4" Spindles - Less Run-outs and Sanding, Higher Production

**SLIDING TABLE GREAT FOR COPING AND TENONING**

13 1/4" x 35 1/2" Sliding Table Travels 217/8"

**Straight Table Models**  
 02344 - 5HP, single phase.....\$3,644.63  
 02344T - 7 1/2HP, 3 phase.....\$3,644.63  
 02344B - without electric.....\$2,929.29

**Sliding Table Models**  
 02344S - 5HP, single phase.....\$3,555.00  
 02344BS - without electric.....\$3,333.33

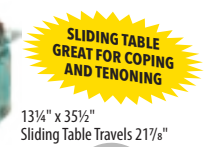

**Heavy Duty Glue Line 12" Straight Line**  
 Rip Saw Accura 03212VB  
 12" Blade 3-3/8" Thickness Capacity  
 50-100 FPM Manual Oiling  
 18 1/2" Throat Capacity

03212V 15 hp.....\$11,999.11  
 03212VB Without Electric.....\$11,888.11

**Dovetail Machine 11" cap.**  
 01045 Manual damping.....\$3,544.53

**Dovetail Machine 16 1/2" cap.**  
 01065 Air damping.....\$4,555.54

**Accura 02218 18" Upcut Saw**  
 10 hp with 84" in-feed and out-feed tables.....\$6,566.67  
 24" Special Order.....\$7,879.80

**ShopFox Hybrid Table Saw W1837**.....\$1,299.21

**ShopFox 19" Bandsaw W1729**.....\$2,188.02

**Accura 02020**  
 20" Bandsaw Without electric.....\$1,917.15  
 3 hp.....\$1,977.91

**ShopFox W1702 Shaper**  
 1/2 inch three-quarter inch and 1 inch spindles included.....\$1,744.71

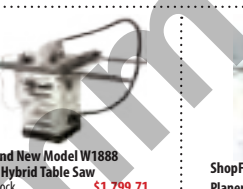
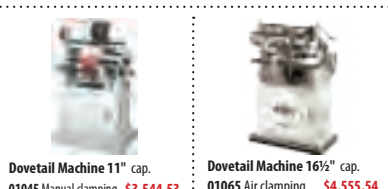

**Accura 6" x 108" Oscillating Edge Sander 3hp, 1ph**  
 03108 with spindle sanding attachment.....\$2,949.69

**Accura Oscillating Combination Stroke Sander Edge Sander 01560** 6" x 186" belt, 3hp, 3ph.....\$4,888.84

**Brand New Model W1888**  
 2hp Hybrid Table Saw in stock.....\$1,799.71

**ShopFox W1812 - 7" Molder Planer** Variable Speed.....\$1,999.91

**ShopFox W1852 - 22" x 48"**  
 Variable Speed Wood Lathe.....\$2,744.77

**ShopFox 10HP 37" Dual Drum Sander W1772**.....Sale \$6,162.63

**Accura Power Feeder**  
 03302 1/8hp "Baby".....\$433.34

**Accura Power Feeder**  
 03301 1/4hp.....\$645.46

**Accura Power Feeders**  
 03303 1/2hp 3 wheel.....\$955.59  
 03304 track feeder.....\$1888.01  
 03321 1hp 3 wheel.....\$1155.00  
 03341 1hp 4 wheel, 8 speed.....\$1388.31

**NEW ACCURA DC VARIABLE SPEED EASY POWER FEEDERS**

03330 1/2hp 3 roll 5-72 FPM.....\$1,288.21  
 03340 1/2hp 4 roll 7-72 FPM.....\$1,355.31  
 03370 2/3hp 7 roll 7-86 FPM.....\$1,788.71

**NEW JOBSITE MACHINES**  
 W1877 13" Planer with Carbide Spiral head.....\$888.88  
 W1876 6" Jointer with carbide spiral head.....\$588.88

**Dust Collector**  
 3hp, 4 bag W1687.....\$747.47

**Dust Collectors**  
 1hp W1727.....\$333.33  
 1 1/2hp W1685.....\$524.25  
 2hp W1666.....\$555.55

**Shop Fox Portable Cyclone Dust Collector**

**NEW ITEM**

- Motor: 3 HP, 220V, 3450 RPM, 18A
- Air suction capacity: 1841 CFM
- Static pressure: 11.0"
- Collection drum size: 35 gallon
- Approximate shipping weight: 419 lbs.

W1869.....\$2,100.00

**METAL WORKING**

**OUR BEST SELLING METAL BANDSAW!**

**Accura 01079VS** - 9" x 7" Capacity Swivel Head 60° maximum Hydraulic down feed, 1" wide band 1.5hp, 220V - 1ph, 85-295 fpm v-speed.....\$2,223.24  
 Without electric use a Flex Shaft.....\$2,120.19

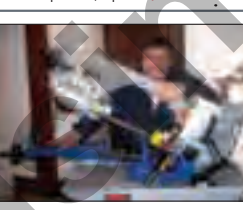

**ShopFox W1811 10" 5HP**  
 Sliding Table Saw with Scoring Blade.....\$4,688.64

**ShopFox W1668 13" Bench**  
 oscillating.....\$577.75

**ShopFox W1848 13" Floor**  
 oscillating.....\$595.95

**ShopFox W1670**  
 34" Radial arm floor.....\$555.55

**ShopFox W171680**  
 floor.....\$818.18

**Accura Vertical**  
 Variable Speed Metal Bandsaw with Blade Welders

01149 14" throat, 9" thickness cap.....\$3,188.13  
 01810 18" throat, 10" thickness cap.....\$3,636.36

**00125 - Metal Bandsaw**  
 5" capacity swivel head, portable.....\$494.94

**ShopFox W1715 Metal Bandsaw**  
 4" x 6" horizontal or vertical.....\$595.95

**Accura 01712 - Metal Bandsaw**  
 7" x 12" horizontal or vertical.....\$1,288.21

**Accura 01916 - Metal Bandsaw**  
 9" x 16" capacity.....\$3,536.37

**Accura 01016 - Metal Bandsaw**  
 10" x 16" capacity, swivel head.....\$5,555.55



**00315 - Circular Cold Saw**  
 12", 1ph, 2.5hp, Coolant.....\$2,222.22

**ShopFox W1843 Knife Belt**  
 2" x 72", Grinder.....\$688.86

**Accura Power Slip Roll 04616**  
 50" x 16 gauge.....\$2,999.92

**WIDE BELT SANDERS**  
 W1738 37" 3 PHASE.....\$14,000.14  
 W1737 37" SINGLE PHASE.....\$13,494.31

**ShopFox Box & Brake**  
 M1043 48" x 16 gauge.....\$900.00  
 M1012 48" x 12 gauge.....\$2595.00



# HEARTLAND

SALES AND MACHINE

Your #1 Roll Forming Support Equipment Source



## FEATURES

- 5 HP Electric Over Hydraulic
- Non-electric Model Available
- 12,000 Pound, 60" Coil Capacity
- Remote Control and Buttons
- 64" x 100" Foot Print
- 72" Coil Capacity Available

## HYDRAULIC COIL TIPPER

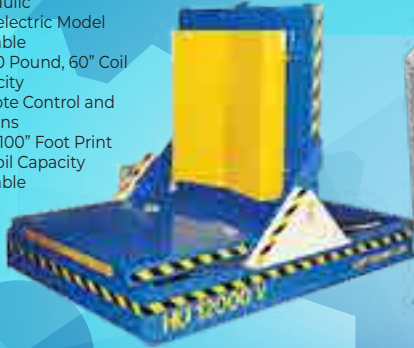

## TRIM WRAPPER



## FEATURES

- 20" Wide Capacity
- 10" Wrap Width
- 1 Hp. Variable Speed
- 120 PSI Air for Clamps
- Non-Electric Model Available
- Optional 10' In-feed/Out-feed Conveyor
- Fast Wrap Speed's
- Optional Automatic Air Clamp



- POWER PANEL WRAPPERS
- POWER TRIM WRAPPERS
- AG PANEL POWER SHEARS
- COIL TIPPERS
- CUSTOM PRODUCTS

Heartland Sales & Machine, LLC  
5176 E. State Road 110  
Rochester, IN 46975  
574.223.6931

## Ee-Zee WRAPPER

Quality control put your product through an EeZee Wrapper



**NEW IMPROVED**  
Now available with 4 Rolls of Film for fast and smooth wrapping

Specializing in  
Orbital Packaging Equipment

Wrap pallets with Model 8420  
Cap. 55" x 55" more sizes available.



Limited in space? Try a Portable Unit.  
Wrap trims with Model 3612, Capacity 14x28. More sizes available.

Better Packaging  
Less Returns  
No Banding Needed

Power Options • Electric • Hydraulic • Air • Honda Engine    Features • Foot Pedal Controls • Variable Speed Ring • Film Changing Without Removing Parts

## Reiff Metal Fabrication

8642 Schwallie Rd Sardinia, OH 45171  
937-446-2767 | Fax 937-446-2727

Call for a  
FREE BROCHURE

## LR Metal Fab

451 Weaverland Valley Rd., East Earl PA 17519  
717-445-7050 | Fax 717-445-7049

Wise men still seek Jesus.

**Plain Tech**  
Simple Solutions For Simple People

- Offering methods to lock down phones and computers
- Copying hard drives
- Recovering accidentally deleted files
- Installing software and more

Call: 918-800-8557 or Fax 417-242-4644 and provide a fax number for more detailed information.

## QUALITY COLOR & GRAIN MATCHED TABLE TOPS & FURNITURE PANELS

Squares - Butcher Blocks  
Stair Treads & Risers  
Custom glued to your sizes & specs

We stock Red Oak, Quarter Sawn White Oak, Cherry, & many other species.

Other Services: Planing, Sanding, Trimming, & Shaping.

**FERN CREST GLUEING**  
99 Fern Crest Road - Quarryville, PA 17566  
717-529-6421 - Isaac K. Beiler

## Now available 5 gallon and 30 gallon Basic H C&A DESIGNS, LLC

**Metal Bed Brackets**  
INTRODUCING THE NEW EZ BRACKETS  
— Easy to Install —

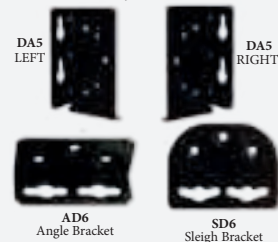

**Cephas Miller**  
5488 TR 401 | Millersburg, OH 44654  
Phone: 330.893.7515 · Fax: 330.893.7012





# We Can Handle It!

**BDH BELTS**

6975A River Rd., Conestoga, PA 17516

**DuroDrive**  
 **LINK V-BELT**

Ph: 717-871-0994 Fax: 717-871-0995 Email: [sales@bdhbelts.com](mailto:sales@bdhbelts.com) Web: [bdhbelts.com](http://bdhbelts.com)

**The Industrial Grade V-Belt Replacement**

*The only totally U.S. owned manufacturer of Link-V-Belting • A Family Company*





Breaks down large square bales to re-bale as small bales

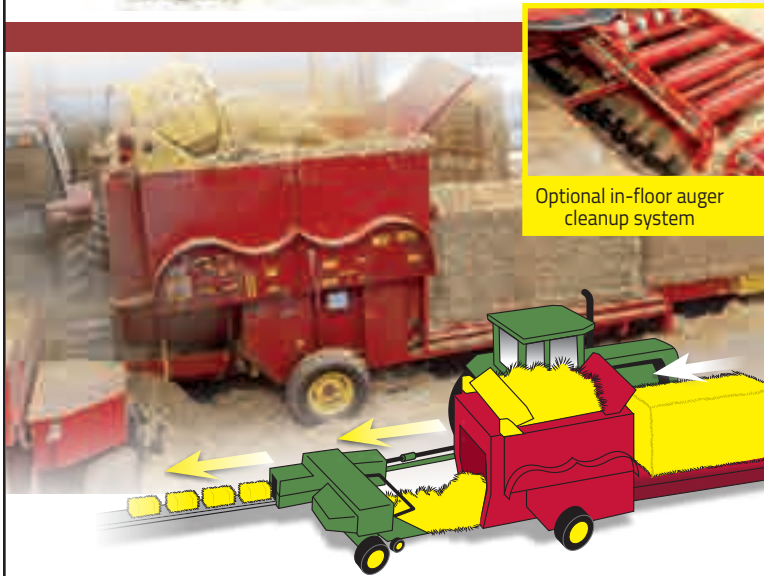

Optional in-floor auger cleanup system

**BLACK ROCK REPAIR**

858 Pumping Station Road ■ Kirkwood, PA 17536  
717-500-6553

**GREAT CHRISTMAS GIFT IDEA!**

**THE LIVING OF THESE DAYS**



In this 252-page book, forty-three Analogist writers share stories and essays about the first five months of the COVID-19 pandemic. Here are some of the stories you will find in *The Living of These Days*:

- COVID-19: (Part 1) April
- Day One from Jacob Munn
- Catching the Virus from Matt
- Does God Care? James Combs
- News Out of Stock: James Munn
- Through the Storm: James Munn
- And They Did Eat: James Munn
- Just Jo's Mask: James Munn
- Christmas: James Munn
- Our Night: James Munn
- From a Series: James Munn
- A Father's Love: James Munn
- The Mystery of COVID: James Munn
- A Promise Only He Can Keep: James Munn

Inspirational reading! Order your copy today. USA retail \$16.00 (Shipping \$4.00) Add \$1.00 shipping for each additional book ordered. Wholesale inquiries welcome.

Please send your orders to:  
High Desert Press  
26 Arad SQ#1  
Farmington, NM 87401  
HighDesertPress@gmail.com  
505-847-7625

**THE LIVING OF THESE DAYS**

**CONTRACTORS, SHED BUILDERS, LUMBER YARDS, AND MORE...**

**PROVIDE YOUR CUSTOMERS WITH MORE OPTIONS!**

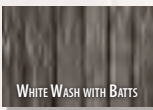

WHITE WASH WITH BATTS

• **Reproduction Barn Wood**  
*Variety of profiles and colors*

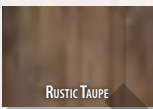

RUSTIC TAUPE

• **Timbers – Milled to Profile or rough sawn**  
*Variety of sizes*

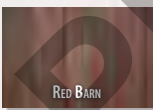

RED BARN

• **Log Siding – Pine and Cedar**  
*Different profiles and width*

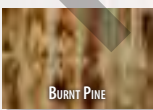

BURNT PINE

• **Car Siding – Pine and Cedar**  
*Various options available*

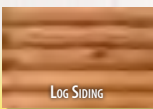

LOG SIDING

• **Many more products available**

**Call NOW to locate your local dealer or to inquire about becoming a dealer yourself.**

**Cedar Ridge Log Home Supply LLC**  
14467 Beechnut Street, Ethel, MO 63539

Phone: 660-486-3216  
Fax: 660-486-3219

**Custom Wood Products**

**SALES & SERVICE**

**CENTAURO COPY LATHES**



Available in 6 Models!

**UNITS AVAILABLE WITH COMPLETE AIR AND HYDRAULIC CONTROLS! NO ELECTRIC NEEDED!**

• **New and Used Lathes in stock at most times!**  
• **Call or write for further information and brochures!**

**VEGA LATHE DUPLICATOR**



Available in 4 Models!

**DUST-PRO DOWNDRAFTS**



Available in Lineshaft

• **1 HP 1725 RPM Motor** • **Double Locking Casters**  
• **110V Plug In** • **36x48 or 36x72 Sizes Available**  
• **Durable Coated Tops** • **Rubber Bumpers**  
• **Reduce Vibrations** • **1 Year Warranty**

**EZ-Gluer**



Harvey Nolt • 250 Peters Road, New Holland, PA 17557  
**717-354-7578 • Toll Free: 888-354-7578 • Fax: 717-354-0242**





# **Power Dog™**

**Hydraulic Powered Equipment**

The "Ambush" mower will out mow & cut cleaner than any other mower in its class! With its proven enclosed deck & full rear discharge it will never clog up. It has a hydrostatic transaxle with ETC, which makes it great on hills & slopes. It also comes with twist grips for instant forward & reverse.



**Available At:**

**Kuhns Power Equipment**

10101 Shively Rd., Nappanee, IN 46550

574-862-4592

**Call today for a dealer near you!**



**Stanley Jr. Toolbox set**  
 STANLEY (R) Jr. real tools offer inspiration, learning and fun for everyone. Tools ergonomically fitted for smaller hands. set includes Toolbox, hammer, Phillips screwdriver no.1 and 2, tape measure, and safety goggles. Ages 5+ Tool box set **\$29.25** Tools only **\$22.50**

**Children's Aprons** made in 3 sizes to give your growing farmers the protection they need to help dad shoe the horses! **Web belt, Leather Knee Patches, Knife Pocket:** Large-both legs, Medium/Small-one leg  
**Colors:** Burgandy, Green, Brown, Navy

Item#	Size	Belt Length	Leg Length	Leg Width	Price
#103	Large	24"-36"	23 3/4"	12 3/4"	\$45.75
#104	Medium	17"-28 1/4"	20"	10"	\$42.85
#105	Small	15"-26 1/4"	16 3/4"	9 1/4"	\$38.25

**Rechargeable 1Z LED Wireless Touch Light**  
 Simply touch the top of the light to select the dim or bright setting as well as to turn on/off powered by a #18650 battery. Includes the USB charging wire Available in white/Orange/Pink **\$22.95 ea**

Up to \$25.00 merchandise .....\$10.00 shipping  
 25.01 to 50.00 .....\$11.00 shipping  
 50.01 to 100.00 .....\$16.00 shipping  
 \$100.01 to \$200.00 .....\$20.00 shipping  
 \$200.00 plus is .....10% shipping  
 Indiana Residence add 7% to the total  
**All prices subject to change.**

**Bowmans Harness Shop LLC**  
 54271 CR 43, Middlebury, IN 46540  
 (574) 825-9569 ext 3

**Little Carpenter Nail Apron**  
 This apron features two double suede leather nail pouches, a leather tape rule holder (which also works great for a flashlight). Nylon belt has a convenient snap on buckle and adjustable size that fits 16"-30" waist.  
 Handmade in USA  
 Nail apron with tools **\$37.95**  
 Without tools **\$17.50**

**Rechargeable Headlights**  
 Lynx 1000 Lm VV7 settings .....\$27.50  
 LED Lenser MH10 600 LM .....\$64.25  
 HTRZ 300 LM .....\$62.00  
 SEO 7R 220 LM .....\$72.20  
 MillerTech #555 1800 LM .....\$55.95  
 #556 750LM .....\$49.95  
 Knight #500 500LM .....\$27.95  
 Knight Mini 200 LM .....\$19.95  
 Luxury LED 150 LM .....\$21.50  
 Princeton Tee Apex 350 LM .....\$110.00  
 We also have non rechargeable headlights. ask for info  
 Shipping : \$4.00 for the first headlight \$2.00 for any additional headlights.

**Softballs & Gloves**  
 14" All Leather Shell .....\$62.50  
 14" Leather Palm - Mesh back .....\$58.95  
 13" Leather Palm - Mesh back .....\$54.60  
 12 1/2" Leather Palm - Mesh back .....\$47.90  
 12 1/2" Leather Palm - Synthetic back .....\$38.50  
 11 1/2" All Leather shell .....\$38.50  
 10 1/2" All Leather shell .....\$31.90  
 Blue/Hot/Gold Dot Softballs .....\$6.10 ea

**No Assembly Required!  
 All Furniture Ships Fully Assembled!**

- 26 Colors to Choose From
- Large Selection of Poly Furniture.
- Contact Us for a Furniture Catalog and Price List
- 4 week lead time on most orders
- Contact Us Today To Place your wholesale order for spring

**Contact Us:**  
 51877 Daffodil Loop Edina MO 63537  
**Phone: 660-341-6462 • Email: dutchboypoly@gmail.com**

**Wholesale Inquiries Only!**

**COOLFOG™ Industrial Fog Systems for Humidification**

Minimize the effects of dry winter environment in your wood shop; control the air humidity with a high pressure fog humidification system

**Dry shop? Call today for more information**

**717-445-6061**  
**JRS AG ASSEMBLIES**  
 Fax: 717-445-9303 268 Pleasant Valley Rd, East Earl PA 17519

**THE GRAIN SAVER**  
 ROLLER MILL QUALITY YOU CAN TRUST

**Dealers Welcome!**

- Commercially case hardened knurled rolls
- Sealed roller bearings
- Heavy duty angle iron frame
- Adjustable rolls for oats or corn
- Rolls approximately 4 to 5 gallons oats per minute
- Rolls approximately 20 pounds of corn per minute
- Electric model available

**ONE YEAR WARRANTY**

**New Double Roll Drive**

**For more information write:**  
**TROYER MACHINE**  
 6187 Woods Church Road  
 Walhonding, OH 43843

Harvest more business by increasing your advertising coverage...

**PCB EXTRA**

**... ask about advertising in the PCBExtra.  
 Call 717-362-1118**



# PRODUCING QUALITY HOUSEWARE ITEMS



**DELUXE BASKET** .....\$13.87  
Strong, durable all around handy basket. Orange, tan and blue colors available. Unique easy to carry design. 1 bushel capacity. 19" L x 17" W x 15.5" H.



**NEW ITEM**  
**HANDY CADDY** .....\$5.50 ea.  
Use to organize cleaners, tools or gather veggies. Blue & tan colors available. 15" x 9 3/4" x 4 1/4" deep.



**NEW ITEM**  
**HANDY TUB** ..... \$5.75 ea.  
All around use as cleaning tub, or storage, potatoes etc. Blue & tan colors available. 12" Round x 6 1/4" deep.



**CHICKADEE BAKING PAN** ..... \$57.50  
Stainless steel pan. BPA free lid. Clear, blue and pink colors available. Provides a nice and even bake. Cleans without scratching. Will not emit toxins when heated. 10-1/2" W X 15" L X 1-3/8" D.



**CUTLERY TRAYS** .....\$4.03  
Slotted compartments for organized storage. Tan and blue colors available. 11-5/8" x 13-5/8 x 2" H.



**NEW ITEM**  
**SHOPPING TOTE** .....\$6.50 ea.  
Grab, go small grocery runs, personal laundry tote, Maganize storage etc. Blue & Pink colors available. 16" x 7" x 12" deep.



**ZOOM BROOM** ..... \$25.00  
Soft bristles with angled ends for easy household cleaning. 54 inch handle included. 18" W at bristle tips, 5.5" H x 2" thick.



**MOLDED POLY TOY FENCE** ..... \$16.65 per set  
Makes any size self-standing barnyard. Set clips together and folds neatly for storage. Each set is over 5' L x 2-1/2" H.

**CALL AND ASK ABOUT WHOLESALE PRICING ▲**

**We help you take the steps necessary to obtain success.**

**Custom designed and produced for Millertech.**



AVAILABLE FROM



**CUSTOM PLASTIC INJECTION MOLDING**

**ASK US ABOUT YOUR INJECTION MOLDING NEEDS**



QUALITY PLASTICS, LLC

9599 SOUTH APPLE CREEK ROAD, FREDERICKSBURG, OHIO 44627

PHONE 330.695.5900

# ***STEP BY STEP***



## ***SUNSET EQUIPMENT***

Producing an Affordable Horse Walker

LEROY MARTIN



Horses enjoy the Walker  
Image Credit: Sunset Equipment



A horse exercises in a Sunset Walker  
Image Credit: Sunset Equipment



The Sunset Horse Walker has been a benefit to many horse owners for some time now, thanks to the diligent designing of Norman and Mark Miller. The Millers are an uncle and nephew team who enjoy horses and were happy to create a reliable product that horse owners say has helped them more effectively train and exercise their horses on a consistent basis.

There was a lot to figure out during the initial designing process, but Mark and Norman were dedicated in staying on course. They had invested significant time and energy into their project, and step by step, the Sunset Horse Walker reached its completion phase and was ready to be marketed.

“After we were approached by Jerry Yoder, a local horseman, who informed us that there is a need for a reliable and affordable horse walker, we took upon ourselves the challenge of conducting some extensive designing and engineering. After many hours of work, we finally developed the Sunset Horse Walker,” Norman explained.

The need for a horse walker is perhaps most evident on properties with small lots where owners have several horses. Due to the cramped spaces on small lots, horses typically don’t have adequate room in which to be exercised other than the horse walking unit. Owners might hold jobs throughout the day and cannot drive the horses on the road on a regular basis. By installing a horse walking unit, horses can receive that beneficial exercise.

“Horses need to be exercised regularly,” Mark said. “Our walker helps prepare horses that are scheduled for the auction. Horse owners love these units because it helps them prep their horses in a more effective, time-saving manner. Prepping a horse for auction is just one of the many applications that our walker can be used for.”

Many horse enthusiasts have purchased the walking units as an aid in training their horses. The walkers can help with habit breaking techniques and behavior modification. “One of the primary ways in which these units are beneficial is it helps the horse’s brain to focus better. By increasing the focus, the horse is more concentrated on what is happening at that exact moment,” he added.

When the mind of a horse is focused, it brings good results, therefore effective handling can be done in a more effective manner, according to the Millers.

These units are powered by either hydraulic or electricity. There is also a belt-driven, gas-powered option in process. The Millers are unsure when that model will be available.

“The one that we are really focused on now is our free-flow version,” Mark explained. “The horses aren’t tied to anything. There are gates in front of them and behind that are moving and can be “hot.” The horses travel within that circle, in the direction that the gates are moving.”

Since the horses doesn’t want to get shocked, they walk

*Sunset Equipment - Continued on Page 300*

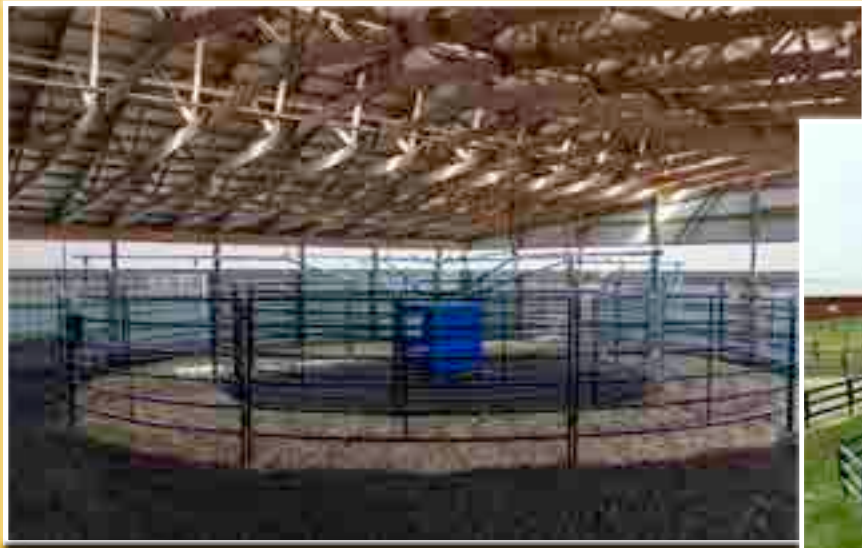

Walkers can be installed indoors and outdoors  
Image Credit: Sunset Equipment

#### *Sunset Equipment - Continued from Page 299*

consistently in the direction the gates are moving. There are variable speeds available per unit, allowing the horse to walk one to fifteen miles per hour. Each unit has adjustable speeds, timers, and can be set to automatically move in a backward or forward motion.

“The timer can be set to any desired time frame,” Mark explained. “For example, if you wanted the walker to change forward or backward motion every five minutes, it could easily be done. Many other settings are available, allowing you to choose the exact increments you want.”

This process isn’t abrupt, and the units will come to a complete stop before changing motions. Additionally, there is adequate room to allow the horse to change its position so the animal can match the directional motion in which it is moving.

Norman conducts all the programming and wiring for the control boxes. “There is quite a bit of programming involved in order to get the Soft-Start function to operate properly,” he said. “I wanted to perform the programming and wiring so I could better understand the product that we were selling. In doing so, it helps us provide better customer service whenever an issue arises with the control boxes. Most times, our customers want the issue resolved as soon as possible, because they want to get the unit up and running again, since many of them use the walkers six days a week.”

The Sunset Horse Walker is ideal for any horse requiring consistent or sporadic exercise. “These units are good for driving horses, saddle horses, as well as draft horses. The units also work well in exercising young stock,” Mark added.

In March of 2018, Sunset Equipment marketed their pilot version of the Sunset Horse Walker. That unit is still being used today on a property in Indiana. Mark explained that there have been changes conducted to their units since the pilot version was sold.

“We have made several improvements since that first model. Also, continuous improvements are being made to new models of the Sunset Horse Walker. Each upgrade and improvement are based on customer feedback and suggestions that they provided. We want our customers to get the maximum potential out of their units.”

Sunset Equipment is currently working on a new design, which would consist of a unit where the horse(s) are tied to the unit, therefore eliminating the surrounding gates. That newer unit would probably be more effective for saddle horses and young horses being taught to lead.

The units that are currently on the market can walk as many as four and six horses simultaneously. The four horse model measures fifty feet in diameter while the model that accommodates six horses measures sixty feet in diameter. (One horse can also walk solo in either model).

Remaining focused on producing products that are reliable



and affordable, the Millers chose to design their horse walking units from high-quality steel tubing. They have their own paint room, and the tubing is painted on-site.

“We use a two-component urethane,” Norman explained. “The horse walkers are stocked in our blue and black color profiles. Those colors are standard.”

Sold nationwide, the Sunset Horse Walker occupies small horse operations as well as large stallion farms. “Our walkers are used in many ways, all across the United States from New York to Montana, and Kentucky to Michigan. Operators at stallion farms find the Sunset Horse Walker beneficial in promoting exercise for their horses in a safe and productive manner,” Norman explained.

An interesting piece of interest: *Majestic Monarch*, a show horse that was sold for \$490,000.00 at Mount Hope Auction in 2020, was no stranger to exercising in a Sunset Horse Walker. There have been additional high-priced horses that owners trusted exercising in the Miller’s units.

Much has taken place since 1992, when Norman first dreamt of starting his own business. “We had a desire for a home-based business,” he explained. “We wanted to provide products that were useful to others within the community. We began working out of a forty-year-old barn. All our products were designed on site and were field tested before we marketed them.”

A bale conveyor was among the first items that Sunset Equipment produced. That first item came off the production floor during autumn of 1991. Since then, the company has manufactured various gates for hog and dairy farms, cattle handling equipment, corrals, pens, as well as a host of other farm-related equipment.

In 2015, Norman’s nephew Mark joined the company, and became co-owner and focuses on sales and shipping, relieving Norman of some of the workload. Three years later, in 2018, the company boosted their workforce as they stepped into the equestrian market, while producing their increasingly popular Sunset Horse Walker.

“We decided to manufacture the horse walker because we wanted to provide our customers with a cost-efficient model. The ones that were already on the market at that time were unaffordable to many people that we spoke to. We entered the market because we saw a need for a more cost-effective product for the everyday horse enthusiasts.”

Customers have responded favorably since the Miller’s initial unit stepped into the market. “Some say it is the best investment they have made, regarding their horses,” Mark said. “It saves them lots of time.”

Norman added the following comments. The fellows on Luckiana Farm are saying “It is an awesome asset in

*Sunset Equipment - Continued on Page 302*



The Horse Walker, designed by the fellows at Sunset Equipment  
Image Credit: Leroy Martin

*Sunset Equipment - Continued from Page 301*

conditioning our Standardbred yearlings.”

Harnesses can be placed on the horses prior to their entry of the units. “This helps them get familiarized with wearing a harness while they exercise in a safe manner inside the walker,” Mark added. “If they decide to kick inside the walker, it is much safer than throwing a harness on an unfamiliar horse and immediately hitching it to a buggy.”

Today, Sunset Equipment employs seven individuals, including Norman’s wife Susan who has helped him significantly. The workload was heavy during those initial years, with Norman being the primary designer of the company’s products.

“When the method of round-baling became popular, we began selling bale wrappers, hay tedders, and rakes. Those are items that we don’t manufacture on site. However, other than the previously mentioned items, we manufacture ninety percent of the products that we sell,” Norman explained.

“Without our customers and our employees, we wouldn’t be able to have this home-based business and provide an income for our families and employees. Without them, we simply wouldn’t be in business. I just want to acknowledge that,” Mark concluded.

Norman echoed similar comments. “We appreciate and



Various products are seen at Sunset Equipment headquarters

Image Credit: Leroy Martin

value both our customers and our employees.”

The Millers are also grateful for the good work of two subcontracting shops that perform a significant portion of the welding for their products.

*Sunset Equipment is owned and managed by Norman and Mark Miller. They are manufacturers of horse stalls, gates, bale elevators, and hay feeders. For additional information on the Sunset Horse Walker or any other products they manufacture, you may reach them at: 260.593.9158. The fax number is: 260.593.0257.*

Researched, written, and edited by Leroy Martin for the exclusive use of the Plain Communities Business Exchange, LLC.

## ARE YOU READY TO EXPAND YOUR CONTRACTING BUSINESS IN 2020?

• Call us **TODAY** to find out how **ONE** call can create opportunities you never knew existed and open up a whole new level of financial freedom.

• Join a **NETWORK** of contractors dedicated to your success. We help roofers increase their **PROFITS** dramatically over the season.

• We have a **SUCCESSFUL** business that does millions of **DOLLARS**, and we would love to share with you our know-how.

CALL TODAY

# 1-855-550-0009



# Parkview Shades



Skyline hwd. standard on all shades  
(upgraded from R.series)

**Call or Stop in**

and we will help you get your project started

- Free samples • Blockout • Light Filtering • Translucent • Solar
- Vision shades • Chain operated

**330-440-1970 or 330-473-5469**

7505 CR77 Mbg; Oh 1/2 mile S of Mt. Hope

## Mayhill Supply Maple Syrup Equipment

Proudly serving area producers for  
over 70 years from this location

Hundreds of  
rolls of tubing  
stock

Store opening  
December 13

Shipping  
Daily



10238 Dennison-Ashtabula Road, Orwell, OH

330-583-2892 or 330-442-7407

Fax 1-234-243-2634

## LAZY SUSAN CLOTHESLINES

**8 Models to Choose  
from, 5 arm or 8 arm  
Models Available**

Choose from 70 ft to 220 ft of line



Manufacturer:



16213 S. State Route 44  
Allenwood, PA 17810

**570.547.7229**

**WE SHIP ANYWHERE**



Ask for a brochure to see our  
**NEW OPTIONS!**

### DEALERS:

**TJ Coal,**  
45193 Fairington Road, Spartansburg, PA 16434  
Phone 814-827-9354

**Willow Creek Variety,**  
1745 E 1800 Ave, Oblong IL 62449  
Phone 618-569-4121

**Sunny Side Builders**  
325 Apple Grove School Road,  
Wyoming, DE 19934  
302-674-9667

**Kerry Knepp**  
9912 E. 600 N., Loogootee, IN 47553  
812-709-9883

**Lehman's Energy Source**  
7970 W. 400 S., Topeka, IN 45571  
260-593-0185

**Chester Miller**  
52 Briggs Webb Road, Cub Run, KY 42729  
270-524-5356

**Beachy's Variety**  
639 Smith Road, Seymour, MO 65746

**Byler's Country Store**  
53405 Calais Road, Quaker City, OH 43773

**Benny's Hardware**  
20098 HWY C, Barnett, MO, 65011  
573 378 5005

**Andy Troyer**  
3779 Four Mile Road, Jackson, OH 45640

**Malhon Raber**  
11833 Hudson Road, Greenfield, OH 45123

**Stony Point Supply**  
7880 Stony Point Road, Sugar Creek, OH 44681  
330-852-2600

**County Line Welding**  
7 State Route 655, Mill Creek, PA 17060

**Sunset View Sales**  
412 Griggs Road, Springfield Center, NY 13468  
607-264-3772

**L&S Lumber**  
7501 State Road, 38 Greensfort, IN 47345  
765-969-3175

**Twin Hickory Lawn Furniture**  
S. 6365 County Road G, Hillpoint, WI 53937

**Oak Ridge Sawmill**  
E. 20280 Oak Ridge Road, Augusta, WI 54722

**Church Street Supply**  
7736 Church Street, Panama, NY 14767  
716-355-8867

**Countryside Flowers & Mulch**  
3750 Buchman Trial East, Waynesboro, PA 17268  
717-729-5910

**Millers Hearth and Home**  
74 Maple Drive, Punxsutawney, PA 15767

*We make hydraulic mat drills.*

## Pond Aeration Windmill

Lake • Septic • Well  
5 Sizes • Ship Free

**440.236.3278**

Do it Yourself Kit

100% Wind Powered  
**PondAeration.com**



OUR UNIQUE DESIGN MAKES  
HANGING LAUNDRY A

*Breeze!*

### FEATURES INCLUDE:

- 8", 12", 16" poly or aluminum pulleys
- Powdercoat finish on metal components
- Spring lock mechanism to lock pulley
- Cable guides to prevent derailing
- Galvanized elevator pole



330.403.3010 | [skylineclotheslines.com](http://skylineclotheslines.com)

skylinenter@gmail.com | 5452 TR 377 Millersburg, OH 44654



### MASSAGE CHAIR

- Available with DeWalt, Milwaukee and Makita
- Runtime 2-20 min. Treatment
- Flat rate shipping fee of **\$300<sup>00</sup>**
- Batteries not included.

Price: **\$2899<sup>00</sup>**



### DEWALT FLEXVOLT STEAM IRON

- Requires 2 DeWalt Flex Volt Batteries.
- Runtime: 20-45 min.
- Only available with DeWalt Flex Volt
- Batteries not included.

Price: **\$599<sup>00</sup>**



### DEWALT FLEXVOLT 6 QT. KITCHEN AID MIXER

- Requires 1 DeWalt Flex Volt Battery.
- Only available with DeWalt Flex Volt.
- Batteries not included.

Price: **\$799<sup>00</sup>**

All orders must be prepaid.  
Call for shipping costs.  
**Kit Prices Available**

## SUNRISE SOLUTIONS

6131 CLIFT PIKE MAYS LICK KY 41055

606.206.0067

**DEALER INQUIRIES WELCOME**

  
**NATURAL HOPE**  
HERBALS®

# Resp - ASSURED!

With this salve in your cabinet.



All Natural Healthy ingredients; No petroleum products added. Resp-Eze Salve contains a refreshing blend of aromatic herbs and essential oils that help maintain feelings of clear, easy breathing while promoting calm senses and restful sleep. Can be applied to the chest, back, and bottoms of the feet.

Made with care in our FDA-inspected GMP facility  
Available in many health and bulk food stores.

670 PHILLIPS RD, MILLERSBURG, PA 17061 | 717.692.5100

Your Source for: **Millertech** • **LEDLENSER** • **EMERSON**



flashlights  
headlamps  
spot lights

- LED light bars
- work lights
- high bay lights
- dust-proof corn bulbs
- Millertech lithium batteries



**SUNRISE CIRCUITS**  
270-881-4177  
1673 VAUGHNS GROVE FAIRVIEW RD • PEMBROKE, KY 42266  
PH. 270-881-4177 • FAX 270-885-8374



**Trail Mix (wildlife feed) is available in bulk bins. Distributors needed!**

**Wildlife Treats • Discount Groceries • While Supplies Last!** **Sold Out!**

**Pine Bark/Fir Hunting Blind/Fence**  
Approx. 3'x15' \$49 4'x15' \$59 5'x15' \$69

(Wildlife Feed) **Raw Mixed Nuts etc.**  
(Wildlife Feed) **BBQ Seasoned/Spicy Peanuts**  
(Wildlife Feed) **Roasted Peanuts**  
(Wildlife Feed) **Raw Peanuts w/ redskins**  
5 lb...\$19 10 lb...\$29 20 lb...\$39 45 lb...\$65

**Honey Roast Peanuts**  
Trail Mix (Wildlife Feed)

**Hershey Chocolate Balls w/ Pretzel**  
5 lb...\$21 10 lb...\$42 20 lb...\$89 45 lb...\$169

**Chopped Nuts** (bird feeding) 20 lb...\$35 45 lb...\$55

**Coarse-chopped Roasted Peanuts w/ choc.**

**Real Fruit Filling** (pineapple, etc.) Wt. approx.  
**White Confectionery Drops**

**Dark Choc. Coconut Bars - Discolor M&M's**  
5 lb...\$19 10 lb...\$29 20 lb...\$39 45 lb...\$65

**Great Taste!** **Velveeta Cheese Blocks** Land-O-Lakes  
5 lb...\$24 10 lb...\$36 20 lb...\$55 45 lb...\$99

**Mozzarella Cheese Sticks**  
5 lb...\$25 10 lb...\$39 21 lb...\$59 42 lb...\$109

**Mixed Assorted High End/Gourmet Cheese**  
5 lb...\$22 10 lb...\$33 20 lb...\$49 40 lb...\$79

**White Vanilla Icing** 24 lb...\$45 50 lb...\$89

**Red or Teal Frosting** 14 lb...\$33 28 lb...\$45

**Chocolate Icing** 24 lb...\$47 40 lb...\$65

**Chocolate Frosting** 35 lb...\$65

**Malted Milk Eggs** 7.5 lb...\$21 22 lb...\$39 37 lb...\$59

Some items may be short-dated or outdated (Ad updated 11/11/21)

**\$5<sup>00</sup> Shipping** 4+ Items = **FREE SHIPPING** Per order: AR, DE, IL, IN, KY, MD, MI, MS, NC, NY, OH, PA, TN, VA, VT, WV Canada \$40/package  
Shipping \$10<sup>00</sup> up to 45 lb; \$5<sup>00</sup> per additional pkg; FL, IA, KS, ME, MO, MN, NE, OK, WI 4+ Items = **\$5 OFF SHIPPING** | Shipping \$15<sup>00</sup> 1st package, \$10<sup>00</sup> per additional package; AZ, CO, ID, MT, ND, NM, SD, TX, UT, WY 4+ Items = **\$5 OFF SHIPPING**

**5% OFF Orders of \$250**

**Competitive Commodities LLC** Mail order: If item is **SOLD OUT**, shall we substitute? Yes, unless otherwise specified  
22 Indian Mills Road | Ballard, WV 24918  
Recorded updates (304) 753-8228 ext 1  
Need a larger volume? Give us a call! Ext 7. 8:00 AM

Order through your local distributor, Or order today by mail or phone.

Approx 1 1/4 lb Sample \$9.00 each + S&H

<b>Ginger Snaps</b> 	<b>Fruit Slices</b> 	<b>OFFER YOUR COMMUNITY GREAT DEALS!</b> <b>Being a distributor is easy!</b> <input type="checkbox"/> Obtain a wholesale price list. <input type="checkbox"/> Take orders from your community. <input type="checkbox"/> Have it shipped to a business address. <input type="checkbox"/> Distribute! Restrictions apply (304)753-8228 Ext 7 8:30 AM ET	
<b>Tongue Teasers</b> 	<b>Lemon Drops</b> 	<b>Mixed Fruit Hard Candy</b> 	<b>Dark Choc. Coconut Bars</b> 
<b>Choc Balls w/ pretzels</b> 	<b>Oreo Cookie Tops</b> 	<b>Liquid Caramel</b> 	<b>Mini Marshmallows</b> 
<b>Hunting Blind</b> 	<b>Mozzarella Cheese Sticks</b> 	<b>Trail Mix</b> 	<b>Honey-Roasted Peanuts</b> 
<b>Cheese Block</b> 	<b>M&amp;M's</b> 	<b>Uncoated Peanut M&amp;M's</b> 	<b>Milk Choc. Wafers</b> 

**Was 2021 good? Buy equipment. Save taxes now. Make next year better**

Available for forks

**The post setter that works**

1. The "Telefold" truss boom. Handle metal, lumber and trusses. Handle metal in wind. Folds for transport to trailer width.

2. The "Heavy Set" post setter. Precisely plumb and position the biggest posts using your skid loader. Quick - Simple - Easy!

3. Hydraulic Tamper. Can be powered with skid loader or otherwise.

4. The Overdrive tool pouch. Not so big and heavy. Carry your hammer and screw gun at your side.

**TOOL**

**We ship nationwide!**

**Call us!**  
Ervin: **270-925-5952**  
Caleb: **618-571-3063**

**Tip: Inflation is happening. Raise your labor rates too.**

**The STRONGEST Option**

**Samson**

**Engineer stamped**  
Use single or multiple brackets per post.  
Hot dipped Galvanized or Stainless steel.  
Call for stamped info.

**Designed for Extremes**  
- High winds  
- Top only structures  
- Corrosive environments  
- Demanding Codes  
Material cost is High!  
Fasten that Building Right

**Need an "L Bracket"?**  
We have a better one!

**Dealers Wanted**

**Sell the Best**

**We ship**

**Call: 270-925-5952**

# ARE YOU READY TO FEEL BETTER?



Made in the USA

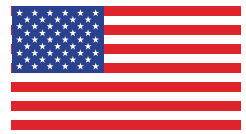

The Home of the All Natural Cleanse that WORKS!

- Aids normal bowel function
- Helps healing process
- Causes colon to move
- Strengthens small intestines
- Destroys candid overgrowth
- Destroys and expels parasites
- Relives gas and cramps



TO BE TAKEN TOGETHER

- Body Detox
- Draws out poison/toxins
- Removes heavy metals
- Removes pharmaceutical drug residual
- Removes radioactive materials
- Cleans walls of colon
- Cleans bowel pockets
- Parasite cleanse

## TESTIMONIALS

This stuff works great!  
PA

Power Cleanse and Power Out have been life changing for me. I believe anyone who has health issues or want to help prevent poor health, I would recommend this product. This is a product where results can be seen. Good luck, to everyone. *KY*

I was on enzymes for terrible constipation and gut disorder for 2 years. I took Power Out and Power Cleanse and problems disappeared. I am now off enzymes. I would recommend anyone with gut disorder to take the power. *KY*

After 9½ years with constipation, indigestion, 3-5 days without bowel movements, pressure headaches, bloating, heartburn, low energy, nausea, anxiety attacks, colon seeming dormant, weakness that kept me from doing even simple daily tasks, not sleeping well, feeling horrible as nothing worked. After taking Power Out & Power Cleanse, I'm back to a full days work. I feel like getting out of bed, best of all 1-3 bowel movements a day. The results have been truly amazing to me, who had very little hope. I don't know where I'd be without this, probably running to doctors with still no answers. *KY*

These statements have not been evaluated by the FDA. This product is not intended to diagnose, treat, cure, or prevent any disease.

### INVOICE/ ORDER FORM

Name \_\_\_\_\_  
Street \_\_\_\_\_  
City, State, Zip \_\_\_\_\_  
Phone \_\_\_\_\_

SHIPPING CHART	
\$0 - 74.99 . . . . .	\$10.00
\$75 - 149.99 . . . . .	\$13.00
\$150 - 299.99 . . . . .	\$16.00
\$300 - 399.99 . . . . .	\$20.00
\$400 - 499.99 . . . . .	\$24.00
Over \$500.00	Free Shipping

Quantity

\_\_\_\_\_ Power Out @ \$24.99 \_\_\_\_\_  
 \_\_\_\_\_ Power Cleanse @ \$44.99 \_\_\_\_\_  
 6% Sales Tax \_\_\_\_\_  
 Shipping \_\_\_\_\_  
 Total \_\_\_\_\_



P.O. Box 700 • Munfordville, Kentucky 42765 • Naturalpowersolutions@ibifax.com • 1-800-313-4712 • Fax: 270-853-2665

**DISTRIBUTORS WELCOME**



# Organizing, Streamlining, Improving? We can help!

**QuickBooks Accounting Software**  
Estimating, Invoicing, Checking, etc.



Bible Reading, Cad Drawing and many other programs

**Microsoft Office Pro**  
Spreadsheets, Word Documents  
Designing & Publishing, etc.

Connect Offices Wirelessly  
← from House to shop →  
across roads, etc



## DeskMate Word Processors



DESKTOP



LAPTOP



2 IN 1

No Internet, No Video, or Sound

We include one hour free support with each new Processor purchase. Our Processors come with a one year limited warranty.

## Protect Your Data

Fireproof  
Waterproof  
Safe



2 in 1 Model

## DATA FUSION Data Processors

Features all of the software capabilities of the DeskMate Word Processor in addition to an electronic email-only service provided by Verizon Wireless and Emypeople, LLC.

Note: The Data Fusion is available on all models shown  
**No Internet, No Video, or Sound**

Provides virtually instant sending and receiving of emails, including any attachments.

**CAN WE HELP WITH YOUR CREDIT CARD PROCESSING?**



No Contracts  
Free Estimates



Poynt

## Sun Lite Enterprise LLC

PO Box 441, 402 Spruce Street, Gratz, PA 17030

Sales Phone: 717-862-5959 ext. 1 | Email: sales@slc.email

Company Fax: 717-365-0911

Support Phone: 717-862-5959 ext. 2 | Email: support@slc.email

## DeskMate/Data Fusion Representatives

- Alamosa, CO - Jason Nissley: 719-589-9679
- Burkesville, KY - Jason R. Schlabach: 270-459-1840
- Crofton, KY - Cephas Beachy: 270-660-9484
- Loogootee, IN - Randall Stoll: 812-709-8480
- Lublin, WI - Ringler Accounting: 715-669-5345
- Mifflinburg, PA - Daniel Martin: 570-217-1146
- New Haven, IN - Schmucker Gifts: 260-385-4735
- Penn Yan, NY - Ivan Martin: 315-536-8705
- Shreve, OH - Arlyn Hershberger: 330-600-1367
- Stevensville, MT - Joseph Stutzman: 406-214-2803
- Versailles, MO - Lee Alan Zimmerman: 573-378-6679

# Weaver Metalworking Machinery

## Quality Used Metal Working Machines

### PRESS BRAKES

Pacific	14 ft.	400 ton hydraulic, 1984
Haco Atlantic	12 ft.	350 ton hydraulic, power back gauge, 2005
Accurpress	14 ft.	320 ton hydraulic, 2-axis cnc control, tooling
Accurpress	12 ft.	250 ton hydraulic, 2-axis cnc gauge, 2000
Adira	13 ft.	220 ton hydraulic, 2-axis cnc gauge
Cincinnati	10 ft.	225 ton mechanical, w. hydraulic motors
Cincinnati	12 ft.	225 ton mechanical, cnc back gauge, 2-speed clutch
Niagara	12 ft.	175 ton hydraulic
Chicago	12 ft.	175 ton mechanical, standard clutch, 18" throat
Diacro	14 ft.	150 ton hydra-mechanical, 2-speed, power back gauge
Verson	14 ft.	150 ton mechanical, flush mount, air clutch
Wysong	14 ft.	140 ton hydraulic, 2-axis cnc control
Cincinnati	12 ft.	135 ton mechanical, 2-speed air clutch
Cincinnati	12 ft.	135 ton mechanical, standard clutch
Cincinnati	10 ft.	135 ton mechanical, standard clutch
Tru-fab	12 ft.	110 ton hydraulic, back gauge
Chicago	12 ft.	90 ton mechanical, 2-speed air clutch, 1990
Chicago	10 ft.	90 ton mechanical, foot treadle, 1979
Chicago	6 ft.	75 ton mechanical, man. back gauge
Diacro	8 ft.	55 ton hydra-mechanical, 2-speed cnc back gauge
Chicago	6 ft.	45 ton mechanical, foot treadle
Adira	5 ft.	33 ton hydraulic, man. back gauge, upating
Allsteel	4 ft.	33 ton hydraulic
Diacro	4 ft.	17 ton hydraulic, back gauge, 4 ft. x 14 ga.
Diacro	4 ft.	12 ton hydraulic, back gauge, 4 ft. x 18 ga. cap.

### SEARERS

Adira	1/2" x 13 ft.	hydraulic, 39" back gauge, 1998
Cincinnati	1/2" x 12 ft.	mechanical, flush mount, 48" back gauge
Accurpress	1/2" x 10 ft.	hydraulic, 48" power back gauge, 1998
Accurpress	3/4" x 10 ft.	hydraulic, 36" power back gauge, 2000
Cincinnati	3/4" x 10 ft.	mechanical, 36" manual back gauge
Cincinnati	3/4" x 6 ft.	mechanical, 36" back gauge
Accurpress	3/4" x 10 ft.	hydraulic, 36" back gauge, 1996
Cincinnati	3/4" x 10 ft.	mechanical, 36" power back gauge
Haco-Atlantic	1/4" x 10 ft.	hydraulic, 36" back gauge, 2011
Cincinnati	7/16" x 12 ft.	mechanical, 36" back gauge
Cincinnati	7/16" x 10 ft.	mechanical, power back gauge
Cincinnati	7/16" x 6 ft.	mechanical, 24" back gauge
Wysong	10 ga. x 10 ft.	mechanical, power back gauge
Niagara	10 ga. x 10 ft.	mechanical, 24" back gauge
Niagara	10 ga. x 8 ft.	mechanical, 24" back gauge
Cincinnati	10 ga. x 4 ft.	mechanical, 24" power back gauge
Niagara	12 ga. x 12 ft.	mechanical, 24" back gauge
Wysong	12 ga. x 10 ft.	mechanical, 24" manual back gauge
Pexto	12 ga. x 4 ft.	mechanical, man. back gauge
Niagara	14 ga. x 10 ft.	mechanical, man. back gauge
Pexto	14 ga. x 6 ft.	mechanical, manual back gauge

Pexto	16 ga. x 4 ft.	hydraulic, man. back gauge
Wysong	18 ga. x 14 ft.	air op., man. back gauge
Wysong	16 ga. x 4 ft.	air op., man. back gauge
Niagara	10 ft.	18 ga. jump shear, 18" back gauge
Pexto	52 in.	16 ga. jump shear, back gauge
Tennsmith	52 in.	16 ga. jump shear, back gauge, NEW, IN STOCK
Pexto	36 in.	16 ga. jump shear, back gauge

### BENDERS, PUNCHES & NOTCHERS

Pedrick	A7 pipe bender, 2" #80 pipe, tooling
Transfluid	pipe bender, 1-7/8" cap., mandrel extractor, tooling
Diacro	#6 & #8 benders, tooled for tube & bar
Whitney Jensen	30 ton punch, mechanical, 24" throat
Linders	pipe notcher, sanding type
Diacro	15 ton, turret punch, 18 sit. turret, gauging table
Euroamc	hydraulic notcher, 8" x 8" x 1/4" cap., var. angle
Amada	hyd. notcher, 8.6" x 8.6" x 1/4" cap.
Profab	corner radius notcher, 1/8" - 1" rad., 1/4" cap., air op.

### ROLLS

Niagara	3/4" x 10 ft.	init. pinch, power roll adj., air drop end
Webb	3/4" x 8 ft.	init. pinch
Webb	3/4" x 8 ft.	init. pinch, v.s. drive
Webb	3/4" x 6 ft.	init. pinch, air drop end
Low	7/8" x 4 ft.	init. pinch, man. drop end
Webb	10 ga. x 8 ft.	init. pinch, air drop end
WDM	16 ga. x 6 ft.	init. pinch, hyd. drive
Low	12 ga. x 4 ft.	init. pinch, man. drop end
Diacro	7/16" x 18" urethane forming roll, true circle	
Roundo	4" x 4" x 1/2" angle roll	
Buffalo	2" x 2" x 1/4" angle roll	

### SAWS

Hydmec	V18, 18" x 32", vertical head, 2000
Hyd-mech	M-20A, 20" x 30" hor., bundling, 10 ft. feed, 2008
Hydmec	S-20A, 13" x 18" hor., 1" blade, auto. feed mitring head, 1996
Kalamazoo	9" x 16" hor., 1" blade
Powermatic	20" contour saw, blade welder

### IRONWORKERS

Geka	165 ton hydraulic, single end punch, tooling
Geka	110 ton hydraulic, 20" shear, 2-speed
Peddighaus	105 ton mechanical, angle & bar shears, notcher
Piranha	90 ton hydraulic, brake attachment, notcher
Scotchman	65 ton hydraulic, 24" bar shear, angle shear
Geka	60 ton hydraulic, auto. back gauge, tooling, 2008
Geka	50 ton hydraulic, notcher, 1 phase, NEW, IN STOCK
Buffalo	50 ton mechanical, coping notcher, tooling
Wysong	21 ton mechanical, punch, 5" bar shear

### LATHES, MILLS & DRILLS

Summit	23" x 80" lathe, 4" bore
Kingston	20" x 60" lathe, 3-1/8" bore
Clausing	17" x 80" lathe, 3-1/8" bore
Birmingham	13" x 40" lathe, 1 phase, tooled
Vetcrax	5 h.p., v.s., 10" x 54" table, Servo p.f.
Bridgeport	1 1/2 h.p., v.s., 9" x 42" table, Servo p.f.
Bridgeport	1 1/2 h.p., v.s., 9" x 42" table, Servo p.f.
Jet	2 h.p., step pulley, 9" x 42" table, 1 phase
Fosdick	radial arm drill, 9" column, 36" arm
Ikeada	radial arm drill, 13" column, 55" arm
Alzmetal	geared head drill press, 26" swing, tapping, power feed
Clausing	20" drill press, v.s.
Rockwell	15" drill press, step pulley

### WELDERS

Miller	Deltaweld 302 amp., 3 phase, Late
Miller	Milleromatic 250, 200 amp., 1 phase
Miller	Synchrowave 250, 250 amp. 1 phase, tig welder
Alphal	40 kva spot welder, water cooled
Sterling	20 kva spot welder, water cooled

### PRESSES

Chicago	125 ton mechanical, air clutch, 36" x 72" bed
Niagara	75 ton mechanical, mech. clutch
Komatsu	60 ton mechanical, air clutch, o.b.i., 4.7" stroke
Niagara	56 ton mechanical, mech. Clutch, o.b.i.
Rouselle	25 ton mechanical, mech. clutch

### SHEET METAL MACHINES

Roper Whitney	12 ft. x 16 ga. Kombi-beam, New CS101 control, 1999
RAS	10 ft. x 12 ga. cnc folder, 3000 control, 60" back gauge

### HAND BRAKES

Tennsmith	12 ft. 4", foot clamping, one man operation, back gauge
Tennsmith	10 ft. 4", foot clamping, one man operation, back gauge
Chicago	14 ft. x 22 ga. straight
Tennsmith	12 ft. x 18 ga. Straight, NEW, IN STOCK
Roper Whitney	10 ft. 12 ga. straight
National	10 ft. 16 ga. Box & pan, 6" finger
Chicago	10 ft. 14 ga. straight
Tennsmith	10 ft. 16 ga. straight, back gauge, NEW, IN STOCK
Tennsmith	10 ft. 18 ga. straight
National	8 ft. 14 ga. finger, 6" finger
Chicago	6 ft. 12 ga. straight
Chicago	6 ft. 12 ga. finger, 8" finger
Tennsmith	4 ft. 12 ga. Box & pan, 4" finger, NEW, IN STOCK
Chicago	4 ft. 12 ga. Box & pan 6" finger
Chicago	4 ft. 14 ga. finger, 6" finger, Reconditioned

Chicago	4 ft. 14 ga. straight
Tennsmith	4 ft. 16 ga. box & pan, NEW, IN STOCK
Tennsmith	4 ft. 22 ga. box & pan, NEW, IN STOCK
Roper-Whitney	4 ft. 20 ga. box & pan

### LOCKFORMERS

Flagler	16 ga. pittsburg & pipe, 2008
Lockformer	rollformers, tooled for tear drop hem
Lockformer	Reeves lock rollformer
Lockformer	Triplex 20 ga. Snaplock, slip & drive
Flagler	20 ga. Snaplock, 1997
Lockformer	20 ga. pittsburg & pipe lock

### SHEARS

Di-Acro	24 in. 16 ga. man. shear
Di-Acro	12 in. 16 ga. man. shear, back gauge
Beverly	B2 man. shear
Maytool	52 in x 10 ga. power ring and circle shear

### ROLLS

Milton	5 ft. 18 ga. man. roll, 3" roll
Pexto	4 ft. 16 ga. man. roll, 3 roll drive, 3" roll
WDM	4 ft. 20 ga. man., 3 roll drive, 2 1/2" roll dia., NEW, IN STOCK
Pexto	3 ft. 14 ga. man., 3 roll drive, 3" roll
Pexto	3 ft. 16 ga. man., 2 1/2" roll dia.
Pexto	3 ft. 22 ga. man., 2" roll dia.
Di-Acro	24 in. 20 ga. man., 2" roll dia.

### MISCELLANEOUS

Maplewood	elbow machine with jigs
Niagara	180 power rotary beader, 12 ga. cap.
Pexto	3617 power rotary beader, 18 ga. cap.
Tennsmith	6" x 6" x 16 ga. notcher
Roper Whitney	6" x 6" x 16 ga. notcher
Niagara	36 in. bar folder
Pexto	30 in. bar folder
Rotex	manual turret punch, 2" dia. cap., 18 stations
Niagara	24 in. throat man. punch, w. brake & shear attach.
Di-Acro	#4 bender w. tooling

**MANY MORE TO CHOOSE FROM**  
New, Used & Recond. press brake tooling in stock, Used shear blades in stock ( New avail.)  
New replacement finger tips for Chicago box brakes in stock.  
We are always looking for good used machinery.

800 W. Lexington Road, Lititz, PA 17543 · Phone: 717-625-0302 · Fax: 717-625-0133 · wmm@ibifax.com



# Krause Products

QUALITY VITAMINS SINCE 1933

**FOR EVERY SIX KRAUSE PRODUCTS YOU BUY, GET THE SEVENTH FREE!**

## Emotion Formula 150 Capsules \$19.00 1 Month Supply

A must for those struggling with moodiness or depression. Contains Tyrosine, Glutamine, St. Johns wart, Ginko Biloba, plus B vitamin. A formula that should promote motivation and reduce fatigue and depression. Important to take before severe depression overwhelms you.



**CUSTOMER COMMENTS**  
This Emotion Formula is amazing! I'm taking 4 a day and feel like a new person. Thank you, MI

"We started our 10 year old on Emotion Formula 1 a day as she was sensitive to everything in everyday life, plus a bedwetter, now a dry bed and a much brighter outlook in life." - Indiana

Qty	ITEM/DESCRIPTION	Cost/Bottle	Total
	B-12 (Sublingual) 1000 mcg, 100 ct.	\$13.50	
	B-50 (Complex) 100 ct.	\$12.50	
	B-6 100 mg., 100 ct.	\$7.95	
	Bedwetting Formula, 4 oz.	\$19.50	
	C-1000 mg. w/Rose Hips 100 ct.	\$12.95	
	C-250 mg. Chewable 100 ct.	\$8.50	
	C-250 mg. Liquid, 4 oz.	\$13.95	
	C-500 mg. w/Rose Hips 100 ct.	\$10.95	
	Calcium Complete 400 mg. 100 ct.	\$13.95	
	Calcium Lactate w/Vit. D 100 ct.	\$9.95	
	Calcium Liquid 16 oz.	\$12.95	
	Co. Q10 60 mg. Chewable 60 ct.	\$15.00	
	Cod Liver Oil 100 Softgel	\$8.95	
	Colostrum + Chewable 90 ct.	\$16.95	
	Colostrum Natural Liquid 16 oz.	\$16.95	
	D-3 1000 IU 100 ct.	\$7.95	
	E-400 IU Natural Vit. 60 Softgel	\$10.95	
	Emotion Formula 150 ct.	\$19.00	
	Geri Formula 120 ct.	\$11.95	
	Healing Ointment, 2 oz.	\$10.95	
	Hospital Powder, 7 oz.	\$16.50	
	Iron (Fumerate) 29 mg., 100 ct.	\$6.50	
	Joint Formula (Improved w/NEM) 120 ct.	\$21.95	
	Mitchella Plus, 100 caps	\$14.95	

Qty	ITEM/DESCRIPTION	Cost/Bottle	Total
	Multi-Vit., Chewable 100 ct.	\$10.95	
	Multi-Vit., Liquid, 16 oz.	\$16.95	
	Multi-Vit., w/Iron, Chewable 100 ct.	\$11.95	
	Muscle Aide Liquid 8 oz.	\$13.25	
	Muscle ease, 4oz.	\$13.95	
	Olive Leaf Ext. 500 mg. Plus 60 ct.	\$13.95	
	Para-Blend Capsules 90 ct.	\$11.95	
	Potassium 100 ct.	\$6.50	
	Pre-Natal - 120 ct.	\$14.95	
	Probiotic Complex 100 ct.	\$16.50	
	Save The Baby Salve, 1.75 oz.	\$8.95	
	Save The Baby Salve, 1.75 oz. "New"	\$9.95	
	Stomach Eze, Chewable 100 ct.	\$6.95	
	Stress/Iron 60 ct.	\$11.95	
	Stress/Zinc 60 ct.	\$11.95	
	Thera Minerals 100 ct.	\$13.95	
	FREE PRODUCTS		
	FREE PRODUCTS		
	FREE PRODUCTS		

Sub Total

**Under 12 products add \$9.00 Shipping & Handling  
Order 12 or more products FREE Shipping  
Unless you order 4 or more 16 oz. bottles of liquids  
for your 12 bottles add \$5.00 for Shipping**

CANADA ORDERS: Call for shipping prices. **TOTAL**

Name \_\_\_\_\_  
Address \_\_\_\_\_  
City \_\_\_\_\_ State \_\_\_\_\_ Zip \_\_\_\_\_  
Phone \_\_\_\_\_

### PREPAID ORDERS ONLY

Mail to: Susie Fisher - 2371 Shippen Dam Rd. • Millersburg, PA 17061  
Questions: 717.692.4302

GREAT PRICES AND QUICK SERVICE ON

## LENOX

BANDSAW BLADES

• WOOD

• METAL

• MEAT CUTTING

• CUSTOM PROFILE  
MOULDER KNIVES

## NORTHWOOD SHARPENING

Quality Work - Fast Turnaround

WE CAN SHARPEN ALMOST ANYTHING  
including Straight Knife and  
Surface Grinding up to 84" length

Glen Martin - W8008 Cloverdale Road  
Greenwood, WI 54437  
phone: 715.669.5147 • fax: 715.669.5148

**AMSOIL**  
Prepare for  
**COLD WEATHER!**

To purchase or for a free catalog contact:  
**James M. Martin**  
717-404-1453  
Independent Dealer  
3123 Leitersburg Rd Waynesboro PA 17268

With **THE SUPER GLIDE**  
you can give him a ride!

Long wearing, abrasive resistant,  
prevents scratches, on most  
floors. Move heavy objects  
with ease, save your back!  
Excellent for all types of  
furniture, mounts with 1" wood screw.

Now available in 4 sizes:  
3/4" \$ .70 each \_\_\_\_\_  
7/8" \$ .75 each \_\_\_\_\_  
1" \$ .80 each \_\_\_\_\_  
1-1/2" \$1.00 each \_\_\_\_\_  
Shipping and Handling: **\$7.50** \_\_\_\_\_  
**TOTAL** \_\_\_\_\_

Write for  
wholesale  
prices.

Send order prepaid to:  
**Eicher's Furniture Glides**  
23813 CR 173 | Kahoka, MO 63445

**LOWEST PRICES ON**

**AMTRAK**

**TICKETS**

**Chris Hartford Travel**  
19 Fairview Drive North  
Haines City, FL 33844

**1-863-695-8304**

**It's Christmas Eve.**

It's the one night of the year when we all  
act a little nicer, we smile a little easier, we  
cheer a little more. For a couple of hours out  
of the whole year, we are the people that we  
always hoped we would be.

~Frank Cross

**Valley Hoop Structures**

3 Brands to  
Choose from **2-5% OFF  
Retail Price**

Delivered Direct to your Location from Manufacture  
Solution from 20' -180' w to suit your needs

- Hay & Grain Storage
- Livestock Production
- Warehouse or Storage
- Garages, Ect.
- Natural Lighting
- Simplified Installation
- Better Performance
- Easy Relocation

Check out the Options! Call for Pricing and Info.  
**(540) - 691-3753**

**Quality**  
WIRE FORMING  
Leola, PA 17540  
phone: 717.656.4478  
Leon Stoltzfus

Welded or Overlapped

- Custom Wire & Rebar Fabricating
- Metal Stamping & Punching
- Wire Straightening & Cutting
- In House Tooling

Wire  
■ ■  
Deformed  
Wire  
■ ■  
Rebar



# FALL CLEARANCE SALE



RELIEF FROM  
PAIN - ANXIETY - SLEEP PROBLEMS  
GENERAL WELLNESS



**CBD - 40% OFF**  
**100% MONEY BACK**  
**GUARANTEE**

**PAIN POINTS**  
**30% OFF**



**SOLD OUT**

14 Piece Essential Oil Set - 10 ml (.33 oz)

100% Pure Therapeutic Grade Organic and Vegan essential oil set of 14 bottles (10ml each). Essential Oil (sandalwood, bergamot, clove, eucalyptus, grapefruit, lavender, lemon, lime, orange, ylang ylang, cinnamon, sweet basil, thyme, rose, cedarwood, and frankincense).

**FREE HEMP LIP BALM**  
**WITH EVERY ORDER**  
**(WHILE SUPPLIES LAST)**



CALL TO ORDER WITH CREDIT OR DEBIT  
**(234) 208-6496**

NAME \_\_\_\_\_  
ADDRESS \_\_\_\_\_  
CITY/STATE/ZIP \_\_\_\_\_

- QTY \_\_\_\_\_ CBD OIL 1500mg 30ml X \$50 = \_\_\_\_\_
- QTY \_\_\_\_\_ CBD OIL 3500mg 30ml X \$70 = \_\_\_\_\_
- QTY \_\_\_\_\_ CBD OIL 5000mg 30ml X \$90 = \_\_\_\_\_
- QTY \_\_\_\_\_ CBD GUMMIES 25PC X \$20 = \_\_\_\_\_
- QTY \_\_\_\_\_ PAIN POINTS SALVE 2oz X \$20 = \_\_\_\_\_
- QTY \_\_\_\_\_ PAIN POINTS CREAM 2oz X \$20 = \_\_\_\_\_
- QTY \_\_\_\_\_ PAIN POINTS PATCH 5PC X \$20 = \_\_\_\_\_
- QTY \_\_\_\_\_ ~~14 PC ESSENTIAL OIL SET X \$50~~ = \_\_\_\_\_

**FREE HEMP LIP BALM**

**FREE CATALOG**

**FREE SHIPPING** orders over \$50  
\$10 Shipping under \$50

TOTAL \_\_\_\_\_

SEND CHECK/MO PLAIN NATUREALS  
1553 TIMBERTOP DR  
TALLMADGE, OHIO 44278



## Clothesline for Overhang, Porches, Basements

CL Model

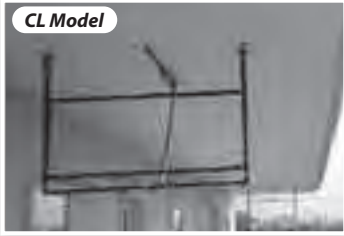

Adjust up and down for the height that you want!  
Adjustable end pole for tight lines every time!



**Clothes Line Pulley System**

**\$140<sup>00</sup>** per set - Vinyl coated line 20¢ per ft.

Shipping Available

CL Model



Easily swings up, out of the way.  
When they are up, the lines remain tight.

**5% OFF**  
thru November  
and December

Ceiling Size 7' - 7'6" .....Item # CL77 ..... \$325<sup>00</sup>

Ceiling Size 8' - 9'6" .....Item # CL89 ..... \$345<sup>00</sup>

Ceiling Size 9'6" - 10'4" .....Item # CL101 ..... \$360<sup>00</sup>

**BUNKER HILL  
APPLIANCE**

4575 TR 365, Millersburg, OH 44654

Monday - Friday: 7:00am - 5:00pm

Saturday: 7:00am - 11:30am

Phone: 330.893.3700

## INTERPACK SYSTEMS, INC.

EXCELLENCE IN PACKAGING SINCE 1992



Packaging Machinery, Materials & Accessories  
Tools & Tool Repair

- Quality • Economy • Service -

5215 Simpson Ferry Road • Mechanicsburg PA 17050

(800) 257-8400 • www.interpackusa.com • interpack@interpackusa.com

## SOIL MIXER TRAY & POT FILLER



**BREAKS BALES,  
MIXES SOIL,  
FILLS AND  
BRUSHES TRAYS,  
PLANTERS  
AND POTS**

573-539-2082

Variable Speed Conveyor & Auger - 220V Single Phase

## DRESS UP and Stay Warm

Now Available

- Coats
- Jackets
- Vests
- Beanies
- and more!

Contact us for Catalog



NEWVILLE, PA



YOUR  
Logo  
Here

## Custom Embroidery Services

717-504-2753 HurstEmbroidery@daystar.io

## ATTENTION Clock Builders

We Sell:

- HERMLE® Mechanical Movements and Kits
- SEIKO Quartz Movements
- RHYTHM 10 Melodie Quartz Chime Movements
- Weather Inserts
- Dials
- Pendulums
- Weight Shells and Sets
- To Fit Grandfather, Grandmother, Wall and Mantel Clocks

Write - Mention code PCBE for a Free Catalog

Buck Hollow Woodcraft - 27470 Cavallo Road, Danville, OH 43014



5000 Fountain Nook Road • Apple Creek, OH 44606

"We're all about Hats!"

**We manufacture the Black Fur Sunday Hat,  
from four different materials, in any style!**

Write us for a Brochure and Price/Order Sheet.

HOURS: Monday - 7:00AM - 8:00PM • Tuesday - Friday - 7:00AM - 5:00PM  
Saturday - 7:00AM - 11:00AM  
CLOSED SUNDAY



- Fully Vented Cupolas
- Lots of Colors and Sizes Available
- Short Lead Times
- Small Family Owned Business



**JD Cupolas**  
2409 Hazletville Rd. • Dover, DE 19904  
Phone Number: **302-734-8272**  
*Leave a Message*

Call or Write for  
**FREE BROCHURE**

## TRAIL CRUISER CARTS

Experience the Difference



**CALL FOR YOUR NEAREST DEALER!**

Manufactured by  
**TL SUPPLIES LLC**  
INSPIRING THE INDUSTRY  
**YOUR EQUINE SUPER STORE!**

6188 TR 419, Millersburg, OH 44654  
P: 330.893.3723 | F: 330.893.0577



# Filtered internet is not the same as ARK.



**ASK US HOW | 330-234-5025**  
INFO@LOGIVISIONTECH.COM

### Attention: Contractors & Business Owners

Just Plain Business offers Landing Pages on our Third-Party Website & manages Google Business Listings for those Church Districts, Fellowships, & Conferences that do not allow the use of individual websites.

JustPlainBusiness.com serves as a hosting platform for Landing Pages that are linked to & can be opened from their Google Business Listing when potential customers find them on Google, either by searching for the business by name or discovering them through keyword search for the product of services offered by the Business. Call for a free, no-obligation consultation.

We work with more than 700 Plain Businesses in 21 States & Canada.

We do NOT offer online sales.  
Call (717)715-3911 / (717)989-1559  
Deon & Valerie Roth of Lancaster County, PA

## LEWIS & HOCKENBERRY INC

KD Squares, Dowels, & Panels



Laminated Squares  
Thicker Pieces  
More Value



Solid Squares  
Best Look

ASH  
CHERRY  
RED OAK  
WHITE OAK  
SOFT MAPLE  
HARD MAPLE

4725 Rich Valley Road, Emporium, PA 15834  
Toll Free 1-888-486-7908  
Fax 814-486-3400  
Email: info@lewhoc.net  
www.lewhoc.net

## M.W. REPAIR & SALES LLC

Tires - New & Repair • Mini Excavators  
Tele Handlers • Custom Hydraulic Hose  
Specialty - Skid Loaders • Construction Equipment Rentals

7am - 4:00pm Mon-Fri • Closed Sat & Sun

**Maynard Whetstone - Sales**  
11315 W 400 S • Millersburg, IN 46543  
(574) 642-3556 • Fax (574) 900-1010

*Work smarter, not harder.*





Up your **PRODUCTION** with an **ACCU-CUT**



**ACCU-CUT EDGER**  
A Cut Beyond

**Accu-Cut Board Edger features:**  
Now improved! With auto tracking feed belt system, plus heavier shaft and bearings throughout the whole machine! Mechanical feed option comes with improved on-the-go speed adjustment giving you a whopping 100-300" per minute feed speed.

Financing available for this machine for as low as \$1.86 per hour. **CALL TODAY TO LEARN HOW**

Don't forget, this machine is totally customized with many built-on options such as:

- Blower System
- Laser Lights
- Hydraulic Options
- Power options & much, much more.

**BUILT JUST FOR YOU!**  
We specialize in a heavy duty machine with many built-on options.

**6586 DECKERVILLE ROAD  
DECKER, MI 48426  
989.872.2391 or 517.852.2115**



**TROOPER**  
Speedometer Combo Kit  
by ROADEdge



**Anywhere Mount!**

Fits right on Dash or use the Optional Multi-Angle Mounting Bracket Assembly for more Applications

**1 YEAR WARRANTY**

- Current speed
- Average speed
- Maximum speed
- (Trip) distance
- Odometer
- Ride time
- Battery voltage
- Stop watch
- Hour meter / Clock
- Accumulated ride time
- Air temperature
- Low battery indicator
- Voltage Range = 1.6 - 52.6
- Choice of Disc or Drum Brake Kits

Ask for the TROOPER Kit at your Local Coach Shop!

**DASHING WOODWORKS LLC**  
405 Cains Rd. Gap, PA 17527  
**CALL 717-808-4315**  
Wholesale Inquiries Welcome!

Need a New Dash? We custom build in a broad range of distinctive styles and finishes. Contact us for Your Catalog!

**We SHIP!**

**Email by Fax**  
Send and receive emails using only your fax machine



- Fast delivery (under 30 seconds typical)
- Barcode system for easy sending
- Free daily weather reports
- All common attachment formats supported
- All you need is a fax machine

Plans starting at only \$4.95/month

**PlainConnect**  
Owned and operated by Plain People

Phone: 717-308-8382  
Fax: 844-545-0650

**JUMPSTART YOUR CORN SEASON BY 2 WEEKS!**

**P7 Series 3-In-1 Planters**  
Plant - Spray - Lay Plastic  
Available in 3 Point, Pulltype, Gas or 12V Lift



**ORDER NOW**  
FOR SPRING AVAILABILITY ON PLANTERS



**JM SHIRK MFG LLC**

**(717) 721-3383**  
459 Peach Rd. Ephrata PA 17522  
Call for FREE Brochure!



# Special Thank You to the Consignors

## Seymour Draft Horse Sale Highlights!



Lot #182  
\$15,500



Lot #207  
\$25,000



Lot #256  
\$17,500



Lot #190  
\$22,000



Lot #240  
\$24,000

**Magnificent  
Reproduction  
Package**

- 14% PROTEIN
- 9% FAT
- ELEVATED OMEGA 3 & 6 LEVELS
- ORGANIC RELATED TRACE MINERALS
- BIOTIN

**For Picky  
Eaters**



**Natural Stamina  
& Energy  
Notice New Hoof  
Growth in 6 Weeks**

- AGGRESSIVE AMINO ACID PACKAGE FOR MAXIMUM MUSCLE GROWTH
- LIVE PRE & PROBIOTIC APPLIED AFTER PELLETING
- FIXING THE MICROBIAL LEVEL IN YOUR HORSE, NOW YOUR HORSE WILL EAT

## Schrock's Feed & Harness

8370 W 300 S • Topeka, IN 46571 • (260) 593-2713 x1 • Mon. - Fri. 7:30am - 4:30pm • Sat. 7:30am - 11:30am  
We deliver farrier, feed & harness supplies every Monday - Friday.

HOOF HEALTH • FOUNDER • ULCERS • WEIGHT LOSS • OFF FEED • COLIC

LACTATING MARES • FERTILITY • HAIR COAT • PERFORMANCE • STAMINA • JOINT DEVELOPMENT

CONTRACTED TENDONS • OVER IN THE KNEES • CROOKED LEGS • ORPHANED FOAL • OCD'S



# THE SILVER ROCKET™

3070 W 350 S • Topeka, IN 46571 • (260) 463 - 4026

The finest in outdoor cooking

The Silver Rocket Grill is a high-quality all-in-one cooking unit with unsurpassed heat containment.

304 Stainless Steel • Extreme Insulation  
Precision Controls • Lasts a lifetime  
Lump Charcoal • Wood Fired

# THE SILVER ROCKET™

Dealer Inquiries Welcome  
Call today and request a catalog



**Blue Ridge Silo, LLC**  
445 Hahnstown Road, Ephrata, PA 17522

Jason Martin, Proprietor

**Serving the  
Mid-Atlantic Region**

Raising the standards  
of the stave silo industry

**Second Location**  
7479 Cedar Springs Road  
Mifflintown, PA 17059  
Phone: 717.733.0104  
Fax: 717.733.0199

## Quality Aluminum Castings



**DM Manufacturing, LLC**  
Dennis Miller, Manager  
7088 Twp. Road 362 | Millersburg, OH 44654  
330.674.0085

Sometimes...



less is more!

Attract attention with,  
**Fúze design** 717-344-2663  
fuzedesign@emypeople.net

## GREEN THUMB SEEDS

"Quality garden seeds, bulk prices,  
with mail order convenience."

- Garden Seeds
- Onion Plants
- Grape & Berry Plants
- Rhubarb & Asparagus Roots
- Organic, Non-Organic Sprays,  
Dusts and Fertilizers
- Plus more

Write to:  
**GREEN THUMB SEEDS**  
8514 NW SR CC Dept. B  
Hamilton, MO 64644  
to request your free catalog.

Old Fashioned Quality  
Since 1946

**Ralph Stuck Lumber**

All PA Hardwoods  
Kiln Dried  
Surfacing and Riping  
Available Upon Request

684 Maeneval Road  
ML Pleasant Mills,  
Pennsylvania 17853  
1-570-539-8666

## BED FASTENERS



**\$10.50 Per Set**

(1 Set per Bed)  
Ohio residents add 7% tax  
\$12.00 Shipping for 1-8 Sets  
\$15.50 Shipping for 9-19 Sets  
20-35 Sets add 9% for Shipping  
36 Sets of more add 7% for Shipping  
10% Off on 12-19 sets  
15% Off on 20-49 sets  
20% Off on 50 or more Sets

**RABER PATTERN WORKS**  
2966 Township Road 163, Baltic, OH 43804



Call or write for more information!  
Two sizes available

Large Train Whistle - \$225.00

Small Train Whistle - \$155.00

Price is post paid  
"Great Train Sound!"

"Your Entire Family Will Love This"

**LONEPINE WOODWORKING**  
(889) 826-1958  
116 W. Kittle Rd., Mio, MI 48647

## Insulated Pipe Sales

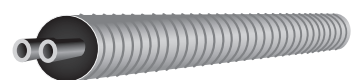

**Dwayne Zimmerman**

610 North Farmersville Road  
Ephrata, PA 17522

**717.859.1733** phone  
**717.859.3833** fax



# Save Hundreds!

**Dump the Cash to Your Bottom Line!**

**When you buy 2 or more hoppers from Iron Bull**

*Savings apply only when purchasing 2 or more of a popular item listed in this ad*

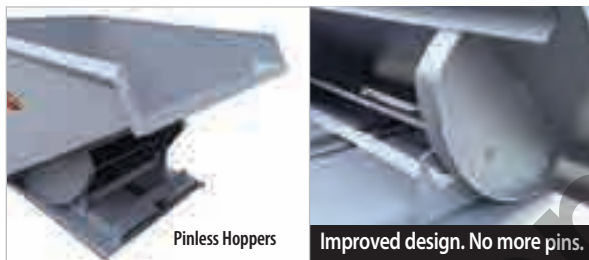

Pinless Hoppers

Improved design. No more pins.



Automatic Push-and-Dump™

Dump without leaving operator seat

### Example of space savings with a Drop-Bottom Hopper

**Conventional hopper**  
- Wasted "Dead" Space  
- Large Footprint

**Drop-Bottom™ hopper**  
- No "Dead" Space  
- Small Footprint

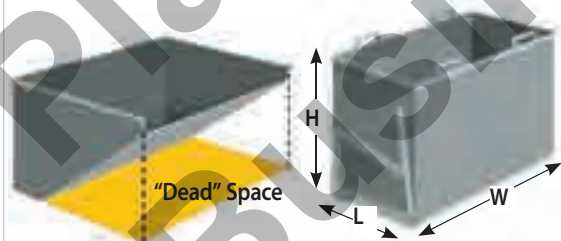

**54% Less Footprint than Standard Hopper**

### Popular Self-Dumping Hoppers

	1 unit price	2-4 unit price	Savings for 2 units
■ 1/2 yd Basic 2000 lb. cap.	\$1,187	<b>\$ 997</b>	<b>\$380</b>
■ 1 yd. Basic 2000 lb. cap.	\$1,489	<b>\$1,217</b>	<b>\$544</b>
■ 1 yd. Heavy Duty Standard 2800 lb. cap.	\$1,667	<b>\$1,397</b>	<b>\$540</b>
■ 2 yd. Basic 2000 lb. cap.	\$1,757	<b>\$1,467</b>	<b>\$580</b>
■ 2 yd. Heavy Duty Standard 2800 lb. cap.	\$1,967	<b>\$1,677</b>	<b>\$580</b>
■ 73" Wide Heavy Duty Standard 2800 cap. (1yd. Stretch Model)	\$2,287	<b>\$1,997</b>	<b>\$580</b>

### Popular Self-Dumping Hopper Options

	1 unit price	2-4 unit price	Savings for 2 units
■ Automatic Push-n-Dump (for Standard models)	\$247	<b>\$207</b>	<b>\$80</b>
■ Automatic Push-n-Dump (for Basic models)	\$277	<b>\$237</b>	<b>\$80</b>

### Popular Drop-Bottom Hopper

	1 unit price	2-4 unit price	Savings for 2 units
■ 1 yd. Basic Drop-Bottom Hopper (1,000 lb. cap.) (38" L x 68" W x 29" H OD)	\$1,697	<b>\$1,497</b>	<b>\$400</b>

### Popular Casters

	1 unit price	2-4 unit price	Savings for 2 units
■ 2" x 4" Phenolic Casters (2 swivel / 2 rigid)	\$187	<b>\$147</b>	<b>\$80</b>
■ 2" x 6" Phenolic Casters (2 swivel / 2 rigid)	\$217	<b>\$177</b>	<b>\$80</b>

*Prices subject to change without notice.*



**Your scrap handling experts**

Orders must be received by Dec 24, 2021.

**Call us today! 765-597-2480**



## Zach's Potatoes

ANNETTA NOLT

One of the marks of a true entrepreneur is taking advantage of the special opportunities you are given. When Zach Garman's father bought a second property, just up the road from the home farm, that came with a nice large root cellar, this 14-year-old entrepreneur saw an opportunity and seized it, and he was busy this past fall picking brown gold out of the ground.

"With such a nice root cellar, it just seemed too bad to have it empty, so my dad suggested I raise some potatoes." Zach told me. "To be honest, I wasn't all that enthused in the beginning. But I plowed up an acre of land on the second farm, and asked our neighbor, who grows about seven acres of potatoes, for advice. I could never have done all this without his help; he bought my seed for me, he gave me all the starting information, he even let me use his equipment. I called him for information every time it was time to do anything with the potatoes. And then when the plants started coming up—that's when I really started getting into this."

"Our family greenhouse business is a good place to sell some of my



Zachary grows potatoes on an acre of land on his father's farm.

Image Credit: Zachary Brubaker





◀ Zach purchased an old digger to harvest the potato crop.

Image Credit: Zachary Brubaker

I was eager to see what seven tons of potatoes looks like, and we headed up the hill to the second farm. Zach opened the barn doors and led the way down a few steps to a well-lit hole in the ground, where we were greeted by an imposing pile of potatoes nearly as tall as myself. I started appreciating a little bit more of the hard physical labor involved in this business

“My grandfather helped me pick them up,” Zach reminisced. “I think he enjoyed the opportunity to work with his grandson on a project like this, because when we were done, he said he really would’ve missed something by not doing this, and that he would have helped me pick up two acres of potatoes.”

After the potatoes were moved to the cellar, Zach grades and bags the potatoes on an as needed basis. “What do you do with the smalls?” I asked.

“Actually, most of the potatoes make the largest grade,” he said. “I’m not sure what I’ll do with the little ones. For now, I just kind of set them aside.” He motioned to a few potatoes along a ledge, and there were indeed very few.

Zach drew my attention to the old grader/bagger. “This was my great-grandfather Henry Garman’s grader. “I’m not sure if he sold potatoes or not, but it is possible that he did if he invested in this piece of equipment. My great-uncle Aaron got a hold of the grader and used it himself, and then it was left and nearly forgotten when his son-in-law left it on the farm. When I started doing potatoes, my uncle Mark said he thinks the grader is still there. I asked about it, and they said if it’s worth twenty-five dollars to me, I can have it.” Zach chuckled. Plainly, the grader is worth that and more to him. “It’s really neat to use my great-grandfather’s piece of equipment. But I admit it’s a little slow for me—I’m thinking of putting a motor on.”

Zach also purchased an old digger. “It needs some help,” he admitted. “But I paid very little for it.”

“Do you see yourself in the produce or greenhouse business for a career?” I asked.

*Zach’s Potatoes - Continued on Page 318*

potatoes. I sell a lot of the smaller-sized bags.” He grinned. “I make the most money on those anyway.”

He sells the 5-pound bags for \$5, 10 pounds for \$8, 20 pounds for \$12, and 50 pounds for \$18. He assured me that he would love to sell the potatoes wholesale as well, and would be happy to negotiate wholesale prices with PCBE readers.

“What kind of potatoes did you plant?” I asked.

“They’re called Eva,” he said. “They’re great for potato chips, and also for French fries, baking, and mashing—really, whatever you want to use them for. Plus they just have a good flavor, they’re attractive, store well, and are self-healing.”

“What does self-healing mean?” I asked.

“When the potato is dropped and slightly bruised, it will heal itself as it cures, instead of rotting,” he said. Zach’s potatoes had just been dug at the time of the interview, and he told me that the potatoes were still acclimating to the root cellar.

*Zach's Potatoes - Continued from Page 317*

He considered. "I don't know... not really. I'm not even completely finished with school yet. But I *am* really enjoying my potatoes."

The Garman family operates a busy greenhouse business in East Earl, Pennsylvania. Zach is a vital part of it. "Zach does a little bit of everything," his dad reported.

In addition to the typical greenhouse offerings, Brier Rose Greenhouse sells landscaping trees, mostly hardwoods and evergreens, and some country/rustic craft, and Zach is involved with both. "It takes a three-man crew to dig trees," he said. "And around Christmas, I take birch logs and flatten one side so it can sit on a mantel, then drill holes for tea lights. I also bundle a few birch logs upright, and of different sizes, with a ribbon, and drill holes in the ends for tea lights. Those sell well. I actually just did an order of 30 bundles, tied with twine, for a florist last week. She wanted to display them on tables at a memorial."

"So you're artistic?" I asked.

He laughed. "Honestly, I'm not that good with wood. I think I



⤴ Zach uses an old grader/bagger that was formerly owned by his great grandfather.

Image Credit: Zachary Brubaker

would do better with metal and a few bolts. My sisters do most of the craft things. Jen grows mini house plants to make fairy gardens that were a hot seller during the worst of COVID, and she and Justina are both good at things like planters and wooden signs. Jalisa enjoys the house more, but she's good at lettering. Jasmine is 11, and right now she'd rather ride her pony than work in the greenhouse."

Zach is not the only entrepreneur in the family. "I have one brother, Tyler, who is pretty involved with the business. He grows horse hay and trees for dad. He does a few thousand arborvitae at one time. He's also the one who sells one-dollar bags of goat feed to the customers who see the animals in the small pasture beside the parking lot." Zach chuckled, "Tyler thought about letting me take over the goat feed, but

⤵ The young entrepreneur sells potatoes in bags of various sizes.

Image Credit: Zachary Brubaker



he makes too much money from it.”

Zach’s mother gives free fertilizer away to customers who bring their own jugs. “But often,” Zach noted, “they forget their containers. So I started collecting jugs—for free—from my aunts and other relatives, and I sell them for 50 cents a piece.”

Zach approximated that an average customer count at the greenhouse is about 350 in summer, and on their top day the count was 500. “Of course, we have fewer than that now,” he added.

The business keeps not only Zach and his sibling busy, but also their parents. Dad does a lot, but Mom is very involved too. She takes care of a lot of the office work.”

I wondered what other interests the young businessman has. “What do you do in your spare time?”

“Spare time!” exclaimed Zach jokingly. Then in a more serious tone he continued, “I help my uncle Mark with milking on weekends or whenever he’s in a tight spot. I’m pretty busy, but I don’t have a lot of hobbies. I collect literature on large Ag tractors and I have a collection of model John Deere’s. I don’t care for hunting—I just don’t get it. I do read some. In our family, you pretty much have to enjoy reading, unless you want to just pace around when everyone else has their nose in a book. I’m not like dad, though. He can sit down and read a book full of plain facts. I like humorous books or anything with a lot of conversation.

# WANTED

**We are looking for stories!** If you are a young businessman and are interested in being featured in this column, contact **Annetta Nolt at 484-641-5211 or write to 313 Moselem Church Road, Kutztown PA 19530** to discuss scheduling your free interview. In addition to inspiring entrepreneurship in young boys, your business will also benefit from the free advertisement.

If your story is published, you will be eligible for a free one-year subscription to PCBE. If you are a current subscriber, a one-year subscription will be added as an extension.

**We look forward to hearing from you!**

I really enjoy my potatoes. And,” he added, “I planted some corn and cut it this fall to make corn shucks to sell to Dad.”

Spoken like a true entrepreneur!

*Annetta Nolt, freelance writer and adoptive parent of Demetrius, (10-26-09) Malachi, (2-7-12) and Haven, (9-23-16) lives in rural Pennsylvania, but finds her stories anywhere. To contact her, call 484-641-5211, or write to 313 Moselem Church Road, Kutztown PA 19530. If you are a young businessman and are interested in being featured in this column, reach out to her at above phone number or address to discuss scheduling your free interview.*

## HOT SPOT HEATER

- ★ Safe, Easy Heat for your Buggy
- ★ Blue Flame – Forced Air
- ★ Battery Adapter & 1 lb Tank
- ★ High Limit Switch Insures Safety
- ★ Convenient Unit Requires No Hookup
- ★ Adjustable up to 7100 BTU’s
- ★ Optional Switch to Mount in your Dash

**\$397**  
+Shipping



TAKE IT  
ANY WHERE!

1887 PINOLA RD  
SHIPPENSBURG PA 17257  
PHONE 717-477-9159

## POLY LUMBER

*Now Available For Sale!*

- 13 Colors
- 12 Ft. Boards
- Multiple Profiles Available
- Available By Piece Or Pallet

**GREEN FOX PLASTICS, LLC™**

BERLIN, OHIO

For More Information  
Contact Jim at  
**330-893-4212**

# Classified Ads

**38.7 acres, 30x70 hay barn, 6 acres pasture,** 32 acres mature hardwoods mostly sugar maple, never tapped. Fertile sandy loam soil, 900ft2 house built in 1995. 15x21 horse barn, 12x32 greenhouse, 3 sheds, outdoor wood boiler. Mulberry, apple, peach and chestnut trees. Great hunting. Yearly income from billboard on property. All mineral rights. Strong Amish community in Clare, MI. \$10,500/acre. Call Alex Abbott (989)572-8772

**40 cubic foot electric chest type freezer** with 2 cold plates, very good condition! \$2,400.00 New cost is \$5,900.00 Call 574-354-7130

**Attention Men: Do you need help buying a great Christmas gift for your wife?** Norwex has on sale now through December 30th. order no later than December 1st. for Christmas. Call Sharon 517-726-1406; 8520 Valley Hwy. Vermont MI 49096

**Attention Metal Fabricators:** Unitized tooling, we buy and sell new and used Strippit, Unipunch, Unitool, Whistler® etc.. Used pricing is 50% of new or less. Units available to pierce as thick as 1/2" mild steel. Ph# 800-990-3437, Fax # 440-327-0909 for one unit or hundreds

**Attention! High quality aluminum** roof coatings, asphalt sealers and more, dealers needed, call Ray 989-550-1999 week days

**ATTENTION! Roofers needed in your area!** We will help you get started! Call before May 1st to receive a free list of buildings in your area!!! Call 660-323-5283

**Buying Reclaimed Lumber beams, boards,** used fence boards. No misc piles. Also large walnut logs over three foot in diameter. Call evenings or Saturday if possible. Lancaster PA 717-413-8393

**Classic Accounting Software.** We can do complete setup, training and data entry. Runs on Windows or Linux. Also Classic word processors and printers for sale. 717-733-8948

**Cold Pressed: Raw linseed oil,** used to preserve hardwood floors etc, Ships anywhere in the US, Call or Write for Pricing. Dealers wanted. Hilltop Variety LLC, 4242 S Ferris Ave, Fremont MI 49412 Phone 231-924-7694, Fax 231-924-1211

**Crossbred Dairy Heifers for sale:** Due to freshen end of year, bred to Murray Grey bull. Central PA. Call 570-985-8656

**Do you love sales?** Do you love residual income? Work fulltime or part time Call 330-201-9373

**Do you, or anyone you know,** have experience with converting a HLVP turbine unit to lineshaft drive? Please let me know what works or doesn't. Raymond Hoover, 10488 Cerulean Rd, Cerulean, KY 42215

## PCBE CLASSIFIED ADS Ad Form & Information

**MUST BE PRE-PAID!** Please send completed submission form with payment to —  
**PCBE Classified Ads** Fax to: 717-427-1602  
 P.O. Box 520 Email to: MT@plaincommunities.com  
 Millersburg, PA 17061

**CALL AFTER THE 17th TO MAKE ARRANGEMENTS**  
 717-362-1118 ext. 2

					\$20.00
\$20.50	\$21.00	\$21.50	\$22.00	\$22.50	\$23.00
\$23.50	\$24.00	\$24.50	\$25.00	\$25.50	\$26.00
\$26.50	\$27.00	\$27.50	\$28.00	\$28.50	\$29.00
\$29.50	\$30.00	\$30.50	\$31.00	\$31.50	\$32.00
\$32.50	\$33.00	\$33.50	\$34.00	\$34.50	\$35.00
\$35.50	\$36.00	\$36.50	\$37.00	\$37.50	\$38.00

1 column width only = 2 3/8 wide. \$20.00 per month for the first 24 words and \$.50 for each additional word. Boxed ad is \$25 per column inch (1 column width only by 3 inches max height). Please print legibly, one word to a box. No refunds for classified ads.

<b>CONTACT INFORMATION NEEDS TO BE INCLUDED IN WORD COUNT ABOVE</b>		Total per Month	_____
<input type="checkbox"/> Business Name (optional)		Number of Months	X _____
<input type="checkbox"/> Name		<b>TOTAL DUE</b>	_____
<input type="checkbox"/> Address	<b>CREDIT CARD INFORMATION</b>		
	Credit Card (please mark one) <input type="checkbox"/> VISA <input type="checkbox"/> MASTER CARD <input type="checkbox"/> DISCOVER		
<input type="checkbox"/> City	State	Zip	Account No. _____
<input type="checkbox"/> Phone	Expiration Date: ____/____/____		3 Digit Security No. _____
<input type="checkbox"/> Fax	Card Holder: _____		
<input type="checkbox"/> Email	Signature: _____		Zip: _____

**New 400 sq. ft. 1/1 In-law suite apartment** available December 1st in Sarasota, FL. Sleeps 4. 3.5 miles from Pinecraft. 14miles to Siesta Beach. 11miles to Lido Beach.

**Excellent Business Opportunity!** Start your own Spray foam contracting business and earn a great living. Unicus Spray Systems can supply the equipment to get you started. See our ad on page 187. Call 414-353-5250.

**Friday Night Stargazer.** News about stars, planets, meteor showers, eclipses, and more. One year, six issues, \$12.00 Sample copy \$2.00; Dogwood Graphics, PO Box 70, Stark City, MO 64866

**K&L Hunting Blinds,** five sided blinds, light weight, polyethylene. Call for more information. Dealers wanted, 5015 South Wisner Ave, Newaygo, MI 49337. Phone 231-924-5711

**Heal your gut, change your life!** The Gut Health Triad from AmPLIFEi addresses Leaky Gut Syndrome. This rarely-diagnosed condition can be the root cause of many common symptoms: allergies, brain fog, chronic fatigue, and more. Try it out! To learn more, call Dave at 717-617-7406. Mention ID #V3456486. Join our team to become the first distributor in your area.

**Hey birders!** Feathers and Friends is a great magazine. Try it now for only \$18.00 a year. Feathers and Friends, 3475 Rte 364, Penn Yan, NY 14527. Phone 315-536-3647

**New 10' x 16' 4 run dog kennel,** sized right for dogs up to 50 lbs. Insulated, lights, 230 volt 40 amp electrical package, tin exterior, truss core and pvc interior, exhaust fan and windows, \$10,500 OBO. Call 315-759-3049



# Classified Ads

## ORGANIC GROCERIES General Groceries

FLT starting at \$12,500.00 plus shipping  
FOB Charlotte

**Frozen Loads: •Cheese •Meat**  
"STOCK UP AT THESE GREAT PRICES"  
- FOREHEAD THERMOMETERS AVAILABLE -  
**New Items Arriving Daily CALL FOR WEEKLY DEALS**  
Doug - 704-277-8007 | Sales - 704-612-9794  
**BARGAIN MAX, INC.**

\*above items may have some out of date or short dated

## COMMERCIAL ROOFERS NEEDED

Are you thinking of starting  
a business or adding a new  
division to your existing  
construction business? Call an  
experienced roofer today for a  
free consultation.

855-835-8885

## 300' VERIZON TOWER

3'x3'x3' triangle. Very heavy  
built. Windmill? Solar? Deer blind  
tower? Bridge? You dream it up!  
\$500 per 20' section OBO.

Sunrise Machine  
6042 Anderson School Rd,  
McLeansboro, IL 62859  
618-308-7225

## NEW PRODUCT ALERT!

The Gut Health Triad from AmpLIFEi  
addresses Leaky Gut Syndrome. This  
rarely-diagnosed condition can be  
the root cause of many common  
symptoms: allergies, brain fog, chronic  
fatigue, and more. Try it out! To learn  
more, call Dave at 717-617-7406.  
Mention ID #V3456486.  
Join our team to become the first  
distributor in your area.

## Online look-up and research

Will order books, hunting & trapping  
supplies, auction listings, butcher  
equipment, parts, etc for you on  
ebay and other online sources. Can  
purchase used or new products for  
you. Tell us what you are looking for  
and we'll do our best to locate! \$10  
minimum up to 15 minutes, 50¢ per  
additional minute.

715-773-2591

**Dealers wanted For:** 24 gauge SS snaplock  
stovepipe type 304 and 316. Other heating  
supplies available. Wholesale and retail.  
Gingerich Stoves and Plumbing LLC 19091  
180th ST Bloomfield IA 52537 641-722-3540  
641-722-3540

## ROOFERS NEEDED!

Start your own commercial roof coating  
business. Training and support provided.  
First 8 callers will get a free marketing  
kit valued at \$500. **330-275-7013**

**Sawmill parts**, new & used Frick parts, Simonds,  
Super Fine saws, Dominator, Eurobit, Piper,  
Eagle Claw, sawbits, shanks, saw wrenches for  
all headsaws, new & old mudsaws, Edmeston  
scales, new mandrels, cable hoists for cranes,  
crane forks. Millers Sawmill Parts, 6027 Cty  
Hwy 18, West Edmeston, NY 13485

**Near I-75, restaurants, shopping.** Pool, gym  
access. Brand new neighborhood. Weekly and  
monthly rates available. 50% deposit required.  
14 day cancellation notice. Transportation  
optional. Call for prices. Cynthia Schrock. 941-  
374-3287.

**New Seiko watches**, 21 jewels, self winding,  
3 year factory warranty. Black, blue, green  
and tan available. \$88.00 each, 3 or more  
\$84.00 ea postpaid. Also have new sports  
models available. 24 jewels, self winding and  
hand winding, same warranty, \$140.00 ea. NY  
residents add 8% tax. More info and photos  
contact Wengerd's Watch Repair, 12318 Seager  
Hill Road, Conewango Valley, NY 14726

**New Warden Force Book!** Book 9, The Worst of  
the Worst by Terry Hodges. Call now to order!  
440-632-0024 Valley View, 15900 Nauvo Rd,  
Middlefield, OH 44062

**WE PRINT LOW COST LABELS** for bakeries,  
butchers, produce, etc on paper or plastic.  
Call or write for prices and samples. Hoover  
Design, 230 Wolf Run Road, Patriot, OH 45658.  
1-888-254-3157

**We advertise puppies.** Flat fee, no  
commissions. Call us for more info at 419-551-  
7492 or 419-298-2714. Check us out at [www.pups4people.com](http://www.pups4people.com)

**Rockwell air skillsaw**, \$125.00, electric heater  
for finish, \$75.00, MVM detail sander, \$60.00,  
1 am air motor excellent, \$45.00, clipmaster  
air clippers excellent, \$110.00, Gravelly Brush  
Hogs, attachments, and good used parts for  
sale, call 440-548-9831

**Sisel Toxin Chemical Free products.** Have new  
weight loss products Sisel Sport and Sisel Thin.  
Also good for other health issues. Sisel can  
also help you with skin disorders, lymes, heart  
conditions, high blood pressure, dyslexia,  
anxiety, depression, and much more. For more  
information and free info product packets  
call Jesse & Barbara Bontrager 574-773-7697.  
72874 CR 15, Nappanee IN, 46550.

**Hamilton Brothers Tool Supermarket:**  
Everybody uses used tools!! Lincoln 260  
Ranger gasoline welder, blowers, 14 inch  
Walker Turner table saw with Beisemeyer  
fence and guard, Hazelthorn pallet notcher,  
7-1/2 hp dust cyclone, 13 inch Parks planer,  
Quincy compressor pump, heavy duty fans,  
Portable forge with 12-volt blower, Porter  
Cable deluxe dovetail omni jig, wood and  
metal lathes, comealong, hoists, threaders,  
generators, pulleys, aluminum ladders, Brakes,  
hoists, stages, vises, airtools and nailers,  
flammable storage cabinets, 80 gallon air

tanks, forges, transits & lasers, Orion Pallet  
Shrink Wrapper, Honda fan, Jigsaws 24", Rollin  
metal bandsaw, Stud welder, Banders, Diacro  
#2 Rotary Bender \$600.00, Maplewood pipe  
lock machine \$555.55. Used dust collectors  
and blowers HVLP sprayers. Sharpening  
Machines. Shapers: Boice Crane & Grizzly.  
Radial Arm Saws, Valve Grinders. Trade ins,  
Punch Presses, 42" Air Shear, Pexto 30" Air-  
powered Barfolder, Phase Converter- 20  
HP/75HP Total Arco Rotophase with magnetic  
starter. \$7500 value, sale \$3333.33; 10 Ton  
Chain Hoist 20' Lift; 36" vertical metal bandsaw  
Jet \$4000; Now in Stock - Rockwell/Delta  
Shaper Spindles, collets, Carbide Saw Grinder,  
26" Blowers - Belt Driven; Gasoline Welder;  
Shingle Lift; New Powermatic Complete  
Spindle Housing Assemblies with pulley,  
bearings, 3 spindles, \$449.99 for model 26  
& 27; Ridgid Contractors Table Saw \$600.00;  
Wood Lathe with duplicator. 30" Pexto Slip  
Roll; Onan Natural Gas Generators, heavy duty  
4000 watt with Transfer Switch, \$800.00 each;  
Sheet Metal Stake Bench and Tools; Sheldon  
13" Lathe, Unisaw, Beverly Shear, 14" Delta  
Bandsaw; Rockwell variable speed Drill Press;  
Honda air compressor \$655.00, Powermatic  
table saw, \$888.00, 18/36 open end drum  
sander, \$600.00, 20" jet planer, Drill Presses!!  
Free listing and flyer 1-800-783-4766.

**WATER ... It's essential to your health and a better you!**

5 stage RO Starting at \$250

Try healthier water with our 8 stage RO

**Bunker Hill HARDWARE**

**R.O.s**

3939 COUNTY RD 435 MILLERSBURG, OH 44654 **330.893.3785**

# NEAL KINSEY

is coming to Lancaster Co., PA for a 3-day introductory level soil seminar!  
**"Feed the Soil and let the Soil Feed the Plant"**

Neal Kinsey will explain the basic foundations of soil balance according to the Albrecht/Kinsey model. Neal has 40+ years of experience working with soils and crops of all types in the USA, Canada and beyond.

**FARMERS and CONSULTANTS, THIS MEETING IS GEARED FOR YOU!**

**Hosted by: Countryside Ag**

**Date:** January 11,12,13 2022 *Deadline: Dec. 31,2021*  
**Time:** 8:00 AM to 5:00 PM  
**Price:** \$625 per person. (includes 7 meals)  
**Location:** The Hoffman Building; 172 S. Lime Street; Quarryville, PA 17566  
**Phone:** 717-806-1968 ex.7

**Other Hosts / Contacts:** Jay Hoover (717) 454-5426; Star Dairy Resources (301) 992-7118; gilson@stardr.biz jayhoover@abcmailbox.net

Lambright Country Chimes LLC Handcrafted Wind Chimes with a Lifetime Warranty

Contact us for wholesale pricing. Call us to receive a catalog!

8340 West US 20 Shipshewana, IN 46565 phone: (260) 768-9138 fax: (260) 768-9183

## Free Shipping in December

### Wall Lights

- Low Battery shutoff
- Bulb Included
- Pull Chain Switch
- Your Choice of Dewalt/Milwaukee or Makita
- Available in Oil Rubbed Bronze or Brushed Nickel

**\$76.00 ea. or 2 or more for \$72.00 ea.**

### Flip it light

- Flip - It light •
- Low Battery Shutoff •
- 15 Watt Bulb Included •
- Other Bulbs Available •
- Hang it Up or Set it Down •
- Your Choice of Dewalt/Milwaukee or Makita •

**\$80.00 ea. or 2 or more for \$75.00 ea.**

### Diffusers

- Low Battery Shutoff
- Low water Shutoff
- Color changing lights
- Your choice Dewalt/Milwaukee or Makita

**\$70.00 ea. or 2 or more for \$67.00 ea.**

**New, Heavy Duty Rubber Socket**

**417-815-2073**

**BATTERIES AVAILABLE**



# HARRISBURG, PENNSYLVANIA, WE ARE COMING!

**Avoid Knee Or Hip Replacement! Avoid Neck Surgery!  
Reverse Neuropathy Foot Pain Symptoms!**



Many patients who have faced the difficult decision of undergoing surgery or spending a lot of time and energy treating their symptoms with medications are getting relief by travelling to Eastern Ohio. But when treatments are typically done twice each week, driving 5 hours each way is NOT an option. For those who live near Eastern Pennsylvania, this is getting fixed!

"We are opening a CTX wellness office in Mechanicsburg/Harrisburg, Pennsylvania to help avoid neck, hip and knee surgeries for patients who have pain and are considering replacement surgery," says Dr. Russ Schroder, DC, DACNB, FACFN, a Board Certified Chiropractic Neurologist. "We have been able to help the majority of patients who have failed traditional chiropractic, physical therapy, massage and typical addictive pain medications that are full of risks. These patients are usually facing surgery, but that may not be the only option."

Because the demand has been so high in the Central and Eastern Pennsylvania area, the CTX Method program is being made available in an office that is going through with contracts and renovations near Harrisburg. The first treatments will be for the neck, knee, hip and feet for the first few months, but unfortunately only TWELVE patients will be able to be accepted for the Fall program.

**To see if you qualify for a consultation and exam for one of these problems, call the new office (still being completed) at 740-297-9100 on Monday, Wednesday, or Fridays to reserve your space in line as we start scheduling exam times early November in the Harrisburg, PA area.**



**Dr. Russ Schroder**  
DC, DACNB, FACFN  
Chiropractic Neurologist



**Dr. Heather Schroder**  
Naturopath

"In my opinion (Dr. Russ's treatment) has been one of the best experiences for the relief of my pain I have had."

**- Dr. Ben Goldberg,  
Retired Physician**

"I came to see Dr. Russ 3 months ago with severe neuropathy (nerve pain) in my feet. Nothing had worked before to help. It wasn't getting better on its own—in fact, I continued to get worse over several years. I wasn't walking very far due to the pain. But since nothing else helped, I went to go see him, and he tested me for nerve sensation in my feet."

It turns out that even though I was having a lot of BAD sensation in my feet, that the nerves were actually very deadened. I could only feel less than 35%! It has been great work getting to his office each week, but the results have been amazing! We just retested and now I have over 80% NORMAL sensation in my feet, and every day I can feel them getting better! Just over the weekend I walked a great distance and even walked barefoot but didn't have ANY of the bad sensations and pain that I used to! Before the treatments, I couldn't even walk barefoot without pain, and having pain the next day! I have referred my family and friends to Dr. Russ and he has been helping them too!"

**- Mable Hershberger**

I went to a specialist and they did an Xray and showed that I had almost bone-on-bone in my left knee. He gave me a cortisone shot and told me I will probably end up having knee surgery. Well, I saw an ad from Dr. Russ. Now I'm through 2 months and lost 30 pounds, can run down steps, and can bike again! Thank you, Dr. Russ, for giving me my life back! You have become family. Highly recommend anyone with knee problems to try this program.

**- Mary Cablentz**

I'm 86 years old and was having pain in my knees and couldn't be on my feet a lot. I had 18 treatments, now I don't have any pain.

**- Anna Yoder**

**NEW LOCATION!**

**Harrisburg / Mechanicsburg, PA • 740-297-9100**

**Zanesville, OH  
300 Main St.  
740-454-1747**

**Goshen, IN  
221 N. Main St.  
740-588-3339**

**Sugarcreek, OH  
771 Dover Rd. NE  
330-852-5131**

**PROFESSIONAL WELLNESS ALLIANCE PROVIDER**



# Holiday Gift Baskets for Employees, Clients & Friends!



Grandpa Basket  
\$51.99

Snack Basket  
\$34.99

Meat-N-Cheese Basket  
\$64.99

Party Basket  
\$59.99

Family Basket  
\$92.99

Holiday Basket  
\$78.99

The Tool Box  
\$129.00

Mini Basket  
\$24.99

Get 8% off  
when you buy  
ten or more  
baskets!

Accepting orders from November 1st through January 5th.

Call or email Dan at:  
717-283-7282 dan@dutchcountrycheesesales.com

649 Churchtown Road, Honey Brook, PA 19344

*Dutch Country*  
CHEESE BASKETS



**Innovative & Quality  
Pneumatic Driver**



**Toughest & Driver Bits  
for Professionals**



## SP-8102BU 1/4" Hexagonal Drive

1/4" Hex Drive



Light  
Weight  
2.6 lbs.

Reverse  
Lever

Double Hammer Clutch  
Impact Mechanism

Air Regulator

## Driver Bits by VESSEL®

● Available in different Tip, Length, and Design

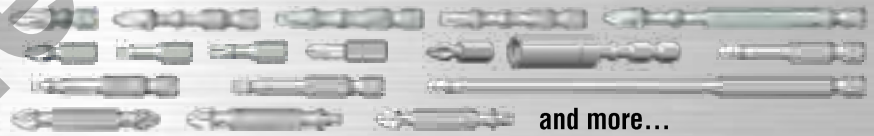

and more...

● Available in different Package



- ✓ Hard to Fracture
- ✓ Superior Wear-Resistance
- ✓ Hard to Distort

**Why so Tough & Durable?**  
Using Special Alloy Steel, and Applying Optimal in-house Heat Treatment with Highest Hardness **62HRC** (generally around 58HRC), yet hard to break because of its special alloy steel together with our technology and knowhow.

**Contact  
Our  
Distributors**

AIR TOOL SHACK  
CHARLOTTE HALL, MD  
301-392-3276

AIR WORKS LTD.  
APPLE CREEK, OH  
330-698-0388

DUTCHMAN'S ENTERPRISES  
KALONA, IA  
319-683-2415

GINGERICH'S SALES  
DRAKESVILLE, IA  
641-722-3016

HERSHBERGER MFG  
POWERSVILLE, MO  
660-592-2026

KEYSTONE AIR POWER LLC  
MYERSTOWN, PA  
717-866-9224

PINE VALLEY BOLTS  
MIDDLEFIELD, OH  
440-693-4232

PLEASANT VALLEY SUPPLY  
PLATTEVILLE, WI  
608-348-2622

STONY POINT HARDWARE  
FREDERICKSBURG, OH  
330-695-2265

LINDEN VALLEY SALES  
BLUE RIVER, WI  
608-872-2369

TIMBERLINE BUILDING PRODUCTS  
WINDSOR, MO  
660-647-2939

YODER SERVICE & SUPPLY  
DUNDEE, OH  
330-359-2300

BLUFF COUNTRY CONSTRUCTION  
EDGEWOOD, IA  
563-329-0352

HERLITZ'S REPAIR & SUPPLY  
MONROE, IN  
260-692-6825

To become  
a **Distributor of  
SP AIR & VESSEL?**  
Contact Sandy Allen  
TEL: 541-935-9628

**VESSEL TOOLS U.S.A., INC.**

2701 Plaza Del Amo #706, Torrance, CA 90503

Toll Free: 855-438-5313 TEL: 614-529-6600 (SP Air Division) Email: da-yamamoto@vessel.co.jp



# Rock Run Cabinetry

## High Quality Aluminum Cabinets



Try the **TWO-TONE** look with our modular, powder-coated cabinets...

*PERFECT* for your mudroom, entrance, second kitchen, basement or shop!



All doors and drawer fronts are laminated with foam, so they don't "bang" like other metal cabinets, and the Toe-kick option has unlimited adjustment with its magnetized attachment to accommodate uneven flooring.



**QUICK  
TURNAROUND**

Easy to Clean | Powder-Coated | Non-Corrosive | Non-Flammable  
Durable | Hygienic | Odorless | Pest-Resistant | Adjustable Legs  
Soft-Close Drawers & Doors | Heavy-Duty Shelf Supports



ROCK RUN CABINETRY | A division of Rock Run Industries | High Quality Aluminum Cabinets

574-536-0603 | [www.rockruncabinetry.com](http://www.rockruncabinetry.com)

**NOTICE:  
Dealers  
Wanted!**

**REELCRAFT**

Wind Things Up With Reelcraft



**YOUR PNEUMATIC SOURCE**

Complete Air Systems



**CHAMPION**



**METAL WORK**  
PNEUMATIC

**Beiler HYDRAULICS**

Innovation That Moves Your Business Forward

322 East Main Street  
Leola, PA 17540  
717-656-4878  
Fax: 717-656-4682



[www.beilerhydraulics.com](http://www.beilerhydraulics.com)

**SHEEP AND GOAT HANDLING EQUIPMENT**

Dealers: **Mountain View Farm Products**, 406 Riggs Road, Friedens, PA 15541 • phone: 814-485-1237  
**Mishiana Farm Supply**, 0105 E 200 N, LaGrange, IN 46761 • phone: 260-463-8113  
**M&M Farms**, 1104 Palm Avenue, Riverside, IA 52327 • phone: 319 201 8666  
**Ezra Miller**, E23313, CTR, CF, Augusta, WI 54722

**Delux Spin Trim Chute**  
Handles animals for hoof trimming, vaccination, de-worming and tagging



- Standard Features**
- All-in-one spinning hoof trimmer & self-catching head gate
  - Makes less appealing tasks easier
  - Fully adjustable to fit all sizes of sheep & goats
  - Shown with padded sides (sold separately)
  - Dimensions: 62"l x 43" w x 45" h

**Head Gate & Chute**  
Self-catching head gate and chute



- Standard Features**
- Ideal for vaccinations, de-worming, tagging, etc.
  - Attaches to front of #WCCT working chute
  - Both sides open for easy access
  - Dimensions: 54"l x 20" w x 40" h

**Analog Scale**  
Sheep and goat scale



**Digital Available**

- Standard Features**
- Both doors open from same end
  - Shorter wheel base for ease maneuverability
  - Also ideal for shipping hogs
  - Solid wheels & slatted floor
  - Optional digital display
  - Dimensions: 52"l x 28" w x 56" h
  - Weight Capacity: 440 lbs

**Lamb Creep Feeder**  
Feeds small square bales and grain



- Standard Features**
- 6' x 6' creep feeder for lambs
  - 12 bu 14 ga. MIG welded steel tank
  - Adjustable openings on creep panel end gate
  - Slide-back water proof lid
  - Moves easily on skids
  - Collapsible for easy shipping and transport

**Working Chute & Crowding Tub**  
Fast and easy way to handle sheep

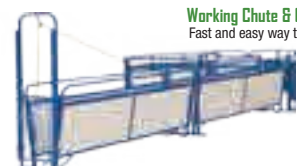

- Standard Features**
- Both doors open from same end
  - Unique design allows all sections to be interchanged
  - 1" x 1" tube frames with 24" height sides
  - 18" wide chute can be narrowed to 10" at bottom for lambs
  - Length of chute can easily be extended by adding extra sections
  - Guillotines and anti-backups can be inserted anywhere along the chute
  - Versatile design allows the unit to adapt quickly and efficiently to your operation

- Aluminum rollers with sealed bearing for long lasting smooth operation on pull-out door
- NEW white plastic sides for better sheep flow
- NEW pull-out revolving door; no more need to chase sheep out of tub & em dash; just pull out and swing around again
- NEW half-circle plastic to eliminate dead spot behind revolving door and funnel animals to chute
- NEW fold-down top bar for easy access to smaller animals in chute

**GATEWAY MANUFACTURING • Leroy Yoder – 7836 E. Colonville Road, Clare, Michigan 48617 • 989-386-4198**

**Basket Feeder For Sheep**  
#SHB For bales up to 5' x 5'



- Standard Features**
- 1 1/4" square tube frame
  - 1 1/2" x 1/4" flat hoops with 7/4" spacing
  - Stacks nicely for transport
  - Dimensions: 66"l x 66" w x 45" h

**Collapsible Feeder**  
#7CF Completely collapsible hay feeder



- Standard Features**
- 7" rod spacing
  - Slanted rods on sides prevent sheep from getting caught as ends move in
  - Dimensions: 72"l x 72" w x 44" h

**Walk-Through Feeder**  
#WTF Feeds small square bales and grain



- Standard Features**
- Basket rod spacing is 2 3/4"
  - 8" alley through center of feeder
  - Attach multiple feeders end-to-end by removing doors
  - Stacks nicely for transport
  - Dimensions: 96"l x 36" w x 38" h

**Big Square Bale Feeder**  
#WTB Feeds large square bales and grain



- Standard Features**
- Improved design for better bale flow
  - Removable wool guards for maximum bale flow
  - Basket rod spacing is 3"
  - Dimensions: 96"l x 48" w x 44" h
  - Designed for bales up to 3' x 3' x 7 1/2"

**Round Bale Feeder**  
#BR5 For large round bales up to 5'



- Standard Features**
- 22 feeding spaces
  - Tombstone design for less hay wastage
  - Dimensions: 62"l x 67" w x 56" h

**Small Bale Feeder**  
#SB4 Small bale feeder with 15 feeding spaces



- Standard Features**
- 15 feeding spaces
  - Design forces goats to lift heads to enter and exit feeder, reducing wastage
  - Feeds hay & grain
  - Dimensions: 48"l x 44" w x 38" h





**Leading the Industry in Design, Engineering, Manufacturing, and Servicing Woodworking Tooling**

Byler services Wood and Plastics Industries with all work done in house at our state of the art service facility. With many years of experience and industry knowledge - we are pleased to have been selected as a Freud Authorized Service Center.

**BYLER INDUSTRIAL TOOL AND SUPPLY LLC**  
1661 Cedar Creek Road  
Vanleer, TN 37181  
615-763-6227

[brad@bylerindustrialtool.com](mailto:brad@bylerindustrialtool.com)

formerly Byler Saw Shop



**freud**  
Precisely the best  
Driving Performance Through Innovation



WE ALSO SELL

# Telescopic Cylinders

**Akaliko**

Akaliko digs deep for the customer & guarantees a performance that is unmatched by competitors.

Heavier wall thickness than any other cylinder.

- A new generation of cylinders with a thicker wall & stronger lifting capacity
- Stronger design with working pressures of 3080 PSI
- Superior chrome-plating technology on all stages improves corrosion resistance & stability throughout the cylinder's life cycle
- High-end gantry-type linear electroplating protects from corrosion & reinforces the cylinder tubing to ensure the highest performance possible
- World renowned seal brands such as Hallite®, Parker®, & NOK® ensures superior sealing performance
- High-quality alloy seamless steel tube materials with excellent mechanical properties
- Improved sealing structure to ensure no leakage under high pressure & harsh working conditions
- Easy-to-maintain without need for special tools
- High-quality cylinders suitable for all lines of distribution as well as major OEMs



610-593-8100

1904 Mine Rd, Paradise PA 17562

Wholesale Inquiries Welcome

## Why Use SNOWGUARDS On Your Roof?

### Available Colors

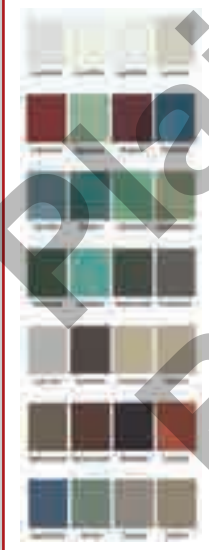

- Falling ice and snow is a liability for your home or business.
- Our SSG and RMG Snow Guards keep ice and snow on the roof instead of having it slide off and causing damage.
- Protect your home, gutters, landscaping, lawn ornaments, others and yourself!



Aaron Zook  
275 W. Center Square Rd  
Leola, PA 17540

**Wholesale & retail customers welcome**  
Contact us and we can give you all the details!

**717-209-0418**

## BETTERWAY EQUIPMENT



## After Market Corn Picker Parts

Call or write for price list:  
**Mullet's Machinery & Parts, LLC**

6870 S. State Road 5, Topeka, IN 46571

phone: 260-593-2960 | fax: 260-593-0551



## COUNTRY CELLULAR, LLC.

4021 CONRAD WEISER PKWY. WOMELSDORF, PA 19567

(610) 589-4065

### HOURS OF OPERATION

Mon, Tues, Wed & Fri: 9 am – 5 pm

Thurs: 9 am – 6 pm

Sat: 9 am – 2 pm

\*\*\* FAMILY OWNED & OPERATED WITH IN-HOUSE CUSTOMER SERVICE\*\*\*

WWW.COUNTRYCELLULARUSA.WIXSITE.COM/CCUSA



### SUNBEAM F1 - 3 VERSIONS

- Talk
- Talk & Text
- Talk, Text, Weather & Navigation

ALL VERSIONS HAVE NO INTERNET OR EMAIL

### LARGE SELECTION OF FLIP & SMART PHONES, DESKTOP & HOME PHONES, TABLETS & WIFI HOTSPOTS

- SMART PHONE & TABLET LOCKDOWN WITH BROWSER AND APP REMOVAL OPTIONS
- BUNDLE & SAVE WITH FAMILY PLANS & PACKAGE DEALS

VERIZON & ATT PROVIDERS – NO CONTRACTS

- UNLIMITED PLANS STARTING AT \$24.00 A MONTH
- HOME PHONE WITH FAX SERVICE – \$21.00 A MONTH
- 5,000 MINUTES FOR A YEAR – \$104.00 (CELL PHONES ONLY)

WIRELESS SIGNAL BOOSTERS – AVAILABLE FOR HOME & OFFICE

GARMIN GPS – SALES & UPDATE SERVICES

BLUETOOTH HEADSETS & HEADPHONES – NOISE CANCELING

WALKIE TALKIES – DUST, WATER & SHOCK RESISTANT



### KYOCERA WALLED GARDEN EXTREME

- NO INTERNET OR EMAIL
- DUST, WATER & SHOCK RESISTANT

# Forms

that you will enjoy filling out.

- sales receipts
- contractor forms
- repair orders
- purchase orders
- bills of lading
- sale contracts
- gift certificates
- and more...

Call or write for a FREE Forms Catalog today!

Print Wares, 1114 Shinham Rd, Greencastle PA 17225  
717-261-6957 • 717-597-9252 fax

## 5 x 10 REFRIGERATED TRAILER



FOR RATES AND AVAILABILITY CALL

**717.445.6991**

East Earl, PA 17519

**FOR RENT!**

Mention this ad for **FREE DELIVERY** within 25 miles!

## Looking for a Christmas gift?

Complete your gift with one of these...

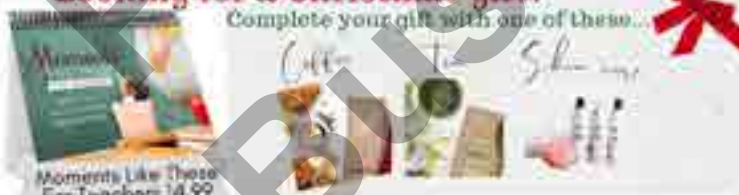

**15% OFF**  
5 or more books...  
Code: PCB15

**New**  
Children's book  
Filled with ABC's,  
numbers, Bible verses,  
& fun activity pages.



Want it sent directly to your front?  
Contact Leigh Ruth Stoltzfus  
717-917-5623  
618 Old Leacock Rd  
Ranko PA 17572

## The PALLET WRAPPER

### Power Options:

- Electric, 110V single phase or 220 volt 3 phase variable speed control
- 24V DC
- Hydraulic
- Air
- Gas
- Flex Shaft

Available with built in scales  
Automated or mechanical  
stretchwrap carriage

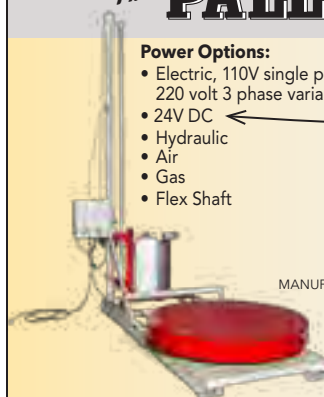

MANUFACTURED BY **T M SUPPLY**

556 Milheim Road, Watsontown, PA 17777  
phone: **570-649-6648**



# Ed's VORTEX Supplies

- Great Gifts for Everyone -

- Scopes
- Binoculars
- Spotting Scopes
- Range Finders



- Lifetime Warranty
- Lowest Prices
- Free Shipping Anywhere
- Specials on discontinued items

WRITE FOR A FREE CATALOG WITH DISCOUNTED PRICES  
E10555 Sugar Grove Road, Readstown, WI 54652

# Offline Wikipedia

"The encyclopedia for a 200-foot bookshelf" . . . Edited for Plain Community

**New!** Print your own 3d parts or make items to sell—Try our new 3d printing package!  
Offline maps—trip routing world-wide, POI's, bookmarks, land terrain. Webless shipping software. 11,500 CAD models, CNC workflow—slicers, controllers, simulators...  
• building sketchup 2500 parts library & dozens of ready-made example house plans.  
• 5000+ cliparts, photos, templates; 240 macros/extensions; 1,125 creative fonts.  
• Project scheduling; Crop planner software; 100 programs such as POS, OCR.

**Pdf catalog:** AutomationDirect, Newark MCM, RS components, CFC Distr, DodgeBearing, Atronics, All electronics, Electronix Express, Marlin Jones, Sparkfun, Sandman, Dick Jones PartsXpress, Herschel Unichains, Abilene, Agmate...

**Request brochure:**  
[samuel@homeofficersource.com](mailto:samuel@homeofficersource.com)  
Fx 888-495-3270 Ph 606-331-0225



- Plus:** 4,700 hymns library  
• Mennonite Encyclopedia  
• Hospital/Lab Pricing  
• 30 Menn. hist. pdf books  
• Deutsch Wikipedia

## Ready to dramatically increase your production results?

Take a Pro-Ag course and become part of the large dedicated growers community.

*A complete soil testing program with 8 free tests  
Learn about the efficiencies of row-placed fertilizer  
Understand the benefits of foliar feeding of your crops  
Average savings of 20% on fertilizing costs*

*"I learn so much, I can't afford not to come.....Mike Highbach*

Contact: Leonard Hostetler — 970-250-8943

# John's Sharpening Service

SHIP TO ADDRESS BELOW

Clippers • Scissors • Cutlery

John A. Miller - Owner  
330-365-7156  
2541 State Route 93  
Sugar creek, OH 44681

SCISSOR  
SHARPENING  
CALL FOR PRICING

CLIPPER BLADE  
SHARPENING  
CALL FOR PRICING

# New Clock Chimes

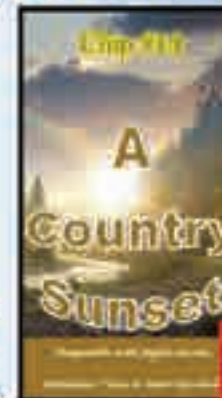
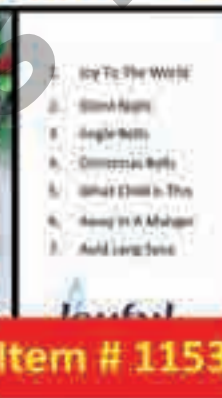
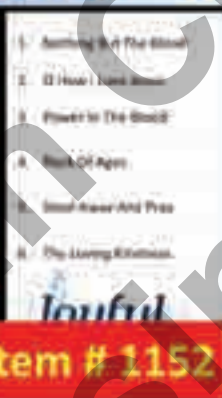
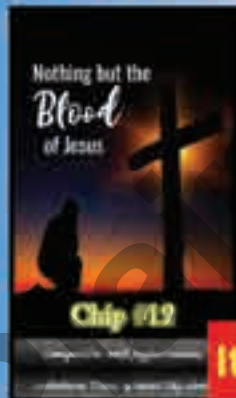

Chips are \$30.00 each Postage paid. **Indiana residents add sale tax = \$32.10**

Credit Cards Accepted

Make checks payable to:



EZ Sales

PO Box 310, Shipshewana, IN 46565

Phone 1-260-668-6543

Dial in info: 1-605-313-5112

Access code 360393#

Sharing ID 10012# 10013# 10014#

Directions 10000#

For Wholesale inquiries call Excell Wholesale @ 260-593-0100



# Holiday Season Giving Opportunity

We thank you for your sponsorship. Without your help, we could not continue to grow, taking the Gospel message to more prisoners.

Would your family be willing to make a special donation to this ministry during this holiday season? Your donations will help us deliver additional gift packages and Bibles to prisoners.

Your special year-end donations will also help us as we head into the new year, enabling us to answer the call from prisons who ask us to come and minister to their prisoners...

Christmas Behind Bars Outreach Ministries delivers gift packages and Bibles to prisoners all throughout the year, not just at Christmas!



**Christmas Behind Bars**  
OUTREACH MINISTRIES

## How to donate to this ministry:

(all donations are tax deductible)

**By Credit Card:** Call 260-827-8835 **By Mail:** Christmas Behind Bars, PO Box 474, Bluffton, IN 46714

**Online:** [ChristmasBehindBars.org/donate](http://ChristmasBehindBars.org/donate)

### New Holland After Market and Used Parts for Manure Spreaders

You name it, we make it!

**MOST PARTS IN STOCK**



- Beaters
- Paddles
- Top Beater Kit
- Tail Gate Kit
- Webs - all sizes
- Hydraulic Drive Kit
- Gear Boxes
- Beater Spline Insert
- Output Spline Shaft
- Gear Box Cover
- Front Belt Cover
- Splash Guard

WE SHIP PARTS  
UPS - FREIGHT - USPS

ALSO MANURE SPREADERS FOR SALE - ALL SIZES  
610-914-1248

**NOLTS KUTZTOWN, PA**

### ESTO LEAF GUARD

We manufacture 5" and 6" leafguard. Heavy .024 gauge aluminium.

We ship anywhere. Wholesale and retail.

John Troyer, Owner

For more information, price and FREE SAMPLE write to:

**ESTO LEAFGUARD**  
28827 New Castle Rd., Howard, OH 43028

### Hoffman Hatchery Inc.

P. O. Box 129BE  
Graz, PA 17030  
Telephone: 717-365-3694

Website: [www.hoffmanhatchery.com](http://www.hoffmanhatchery.com)  
Free Catalog

Chicks, Turkeys, Ducklings, Goslings, Guineas, Bantams, Game birds, Books, and Equipment



### LEARN SPANISH

on the conference line the easy way!

Perfect Spanish ... a language course like no other

- no memorizing
- no writing
- no reading
- no homework

Only 10 minutes a day!

Just sit back, listen, and absorb

Call 712-432-8788

pin: START#

Learning Spanish is easier than you think!

*Michael Thornhill*

### GOOD RECONDITIONED WOODWORKING EQUIPMENT

10" DELTA UNISAWS WITH UNIFENCE.....	\$900.00
JOINTERS WITH BYRD HEADS.....	CALL
POWERMATIC MODEL 26 SHAPER'S 1 1/4" SPINDLES.....	\$1200.00
DELTA 14"-20" BANDSAWS.....	CALL
13 HOLE LINE BORE, DELTA.....	\$1350.00
GRASS - HINGE PRESS - AIR OPERATED.....	\$375.00
BYRD HEADS FOR PLANERS, JOINTERS, SHAPERS.....	CALL
20" AND 24" POWERMATIC PLANERS.....	CALL

REASONABLE FREIGHT RATES

### YODER SALES

1805 270th Street • Redding, IA 50860

### VEGETABLE SEEDS

FREE CATALOG

Better results with:

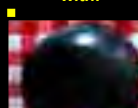

**SWEET GEM WATERMELON**

12 lb. Round, glossy, solid dark-green rind. Firm, crisp, sweet, seedless, dark-red fruit. High yielding. It has a distinctive look and superior flavor.

Sauder Farm Country Market  
959 Britmart Rd, Elton KY 42220  
270-885-1048 fax 270-886-8017

### PURPLE DAISY DESIGN Rubber Stamps & Dies

HUNDREDS OF UNIQUE STAMPS AND DIES



To order our 128 pg. color catalog send \$5.00 for printing and shipping to:

Purple Daisy Design  
8541 Willowdale Road  
Greencastle, PA 17225  
1-888-298-0350

Wholesale Orders Welcome

For Health and Home MEET THE LEADER IN GRAVITY-FED WATER PURIFICATION the Berkey® water purification systems



For replacement Stainless Steel Berkey® Filters

Patrick Holland - 5013 KY-910, Liberty, KY 42539  
606-787-7700



# PINE VALLEY BOLTS



Model MLT3060 - Portable Light unit with Kubota diesel, 8020 hours with 6 KW Generator \$2,500.00  
Good condition



GM671 - Detroit Power unit with clutch  
Model 60456 - s/n 6A-74780  
Runs good, uses some oil and has small oil leak  
\$4,500.00



LaRick 410 shaper sander  
Hyd drive, was working when taken out of service  
2019  
\$4,000.00  
1 1/4 spindle  
Good condition



2008 Delta 18" Bandsaw  
Model 28-682 - 230 volt 1 PH. Like new, set up for cutting metal  
\$1,800.00



10" Delta unisaw with Hyd. motor and 52" uniface  
Model 36-869  
Good condition  
\$1,000.00



16x24x20 Hyd Tank with pump  
Excellent condition  
\$450.00



2006 R HM fluid power  
100 gal Hyd. Tank with hose's and filters  
Good condition  
\$750.00



Jet 18" Bandsaw  
Model - JWBS-18  
115 Volt, 1 Ph 1 1/2 Hp  
Like new  
\$1,750.00



Hyd. Tank 18x48x39  
Worked when taken out of service 10-7-2020 \$350.00



**3-YARD \$1,599**  
**2 1/2-YARD \$1,437.75**  
**2-YARD \$1,269**  
**1 1/2-YARD \$1,134**  
**1-YARD \$999**  
**3/4-YARD \$897.75**

**HOURS:**  
 Mon.-Fri. 7AM-5PM  
 Sat. 7AM to 4PM  
 Closed Sun.

All prices are subject to change without notice.

N ↑		Rt. 87
Rt. 528	★ Partman M. esp. Rd.	Rt. 534

5195 Kinsman Rd. • Middlefield, OH 44062  
 P: 440-693-4232 • F: 440-693-4316



# CODECRAFTERS INTERNATIONAL

## WORK IS IMPORTANT FAMILY MATTERS MORE

This Christmas season, we want to encourage you to take the time to slow down, celebrate with family, and reflect on the blessings of this year.

Does extra downtime find you thinking ahead? Custom software can help you maintain a healthy, productive pace for 2022.

**GIVE US A CALL**  
**(620) 209-4250**





~ Leading Edge Lighting ~



#5404



#5200



#6210



#5421



#5410



#5421

THINK MILWAUKEE + DEWALT

ALSO AVAILABLE IN A TABLETOP VERSION

The latest addition to our Milwalt lineup

#8200 Milwalt Nützlicht

- Fits both Milwaukee and Dewalt batteries. Pictured with our #1136 Unbreakable Light Shield and #6004 15w Dimmable Bulb.

Bulb and shade sold separately.



#8240-P Milwalt Pendant Lamp

with pull chain switch (Available in numerous different shade options)



Lancaster Lanterns LLC

5264 White Oak Rd. Paradise, Pa 17562  
P: (717) 340-4678 F: (717)340-4660

# Letters from Abroad

## MIŠLJENJA I SAVETI O NAŠOJ FARMI: OPINIONS AND ADVICE ABOUT OUR FARM

*Christopher Petrovich*

Up to this point, I haven't said too much about the farm. I've alluded to it at times but without volunteering many details. That's because a novice doesn't have much to contribute while he is still in the process of learning. If you're looking for expert advice, you won't find it here. I'm just sharing what my wife and I passed through in starting a farm with minimal previous experience, no family background, and zero parental assistance.

As I mentioned in the past, I bought the first (12-acre) farm in February 2018. After the May wedding, we set our hands to work on bringing an unfinished house into livable condition. That project kept us busy until winter. In the spring of our second year in Mali Drenovac (2019), we hired a local farmer to plow two fields. He planted the 0.75-acre field in oats and the 1.5-acre field in corn. Lacking time to cultivate the cornfield, the 1.5-acre field was almost a complete loss. But the ironic part is that we barely noticed. It wasn't until November that I remembered to pick the little bit of corn that survived in the midst of the weeds. At least the oat hay turned out nicely. As you can easily surmise, I bought most of what I fed the horses that first year.

I wasn't sure how to get started farming. Yes, I knew I wanted to tend sheep and sell the lambs for meat. But I wasn't sure how to accomplish that considering that strong work horses are expensive in Serbia, work harnesses and horse-drawn equipment are almost non-existent, and only a few elderly men have experience shoeing horses. Even today, I have to import horseshoes from Western Europe for my draft mares. I couldn't get started farming—in any real and meaningful sense—with the horse-drawn equipment that is available in Serbia because you can't feed a flock of sheep from what you can harvest with a walk-behind plow, harrow, scythe, pitchfork, and wagon.

With almost no experience in farming, I decided that if I want to be serious about becoming a farmer then I need to





*Mowing alfalfa hay on the field across the stream from our house.*

Image credit: Christopher Petrovich

learn the work step-by-step, season-by-season, and to do what it takes to gain that experience. I clearly remember a conversation I had with an Old Order Amish neighbor about a decade ago. For many years, he lived in the same community as a man who successfully converted to the Old Order Amish. His father, among others, invested a considerable amount of time and effort teaching this man how to farm with horses. But the tone of his voice revealed that it felt overwhelming for everyone involved. In the end, the convert only took care of the fields that were attached to his homestead. He didn't live from farming. My neighbor wasn't sure the effort was worth the outcome. I interpret that as a cautionary tale about diving straight into horse farming. But I cannot learn by sitting on the sidelines, and won't make any progress leaving our abandoned fields lay fallow. To gain that necessary experience, I bought the most common tractor in Serbia—the IMT 539. It is a 39-horsepower, rear-wheel-drive diesel tractor built on a Massey Ferguson platform in 1992.

Some friends have taken the liberty of pointing out that a tractor is a huge step “forward” technologically. That much is obvious. But these friends still haven't solved the practical dilemma—how can I reach the goal of farming for a living in the near absence of horses, harnesses, and equipment? So far, I've only gotten two types of replies: “It's impossible” and “Ship the horses and equipment from the States.” The first reply is not a real answer. The problem with the second reply is that I don't have the funds, and even if I did, I'm not sure I could recoup the costs. For example, farmers here

*Letters from Abroad - Continued on Page 336*



*Small (0.42-acre) alfalfa field in the center of the village we baled on August 13th.*

Image credit: Christopher Petrovich

*Letters from Abroad - Continued from Page 335*

get about nine cents per pound for tomatoes in-season. How many pounds of tomatoes would I need to sell just to recoup the cost of shipping and import duties on the equipment?

There are additional difficulties. Most of my fields had been abandoned for thirty to fifty years. There are a lot of roots to compete with when plowing, and you don't get very good yields at first. Yes, we got two barns with the first homestead, and one more barn with the Pavlovic homestead. But they're very old, basic structures. There was not a single box stall, no feeding troughs, no waterlines, and no lighting. The existing corn crib was only sufficient for holding about a ton of corn (on the cob), and the grain storage for about four tons of wheat. The farm is no small endeavor. Finding draft horses and training them, buying shoes, finding a local farrier, locating work harnesses and sizing them properly, and finding suitable horse-drawn equipment; installing water lines, feeding troughs, and repairing the roofs of two buildings; building a corn crib and further grain storage; buying healthy animals and learning how to handle them, especially matters related to nutrient and veterinary demands. Overwhelming is an understatement. I believe it was best to buy the tractor for now, especially since horse-drawn equipment doesn't exist in Serbia. Yes, anything can be made. But that requires time and effort, both of which are currently in short supply. This winter I plan to have a friend use a welder to convert an old double-bottom walking plow into a riding plow. I'll let you know how that turns out! Our goal is to switch over to horse farming, implement by implement.

Our goal is 34 acres of pasture divided into seven sections for intensive, rotational grazing; 2.5 acres of corn for silage and a half acre to fill the old corn crib; 5 acres of grain (barley, oats, and wheat); and five acres in alfalfa and red clover for feeding the sheep and horses during the rather brief winter season. We calculate that this amount could feed as many as 120 sheep. We purchased 15 Sjenički ewes, 3 female lambs, and 1 ram the previous autumn. Since then, we have been blessed by the birth of 18 lambs, 14 of which were female. We kept all the female lambs for expanding the flock.





*Our flock of sheep on pasture on Crveni Breg (above our house).*

Image credit: Christopher Petrovich

In August, we bought two additional flocks—6 Karakačanski ewes with 4 lambs and 1 ram; and 6 Svrliški ewes with 4 lambs and a ram whose mother is half Pirotski and half Karakačanski. You may have never heard of these breeds. Hopefully I can write about these unique breeds in a future article sometime.

Now the question is: what do locals think of the farm? I can tell you one thing for certain—everyone has an opinion! Only one family is in near total support, and that's because they support the idea of organic farming. About ten families are positive toward us while being deeply skeptical about our approach, primarily because they doubt the effectiveness of pastures, and don't understand the benefits of intensive grazing. Nearly all serious farmers fall into this category. Although we cooperate in multiple ways, they are especially skeptical regarding the effectiveness of horse farming and the financial outlook for the organic market in Serbia, and occasionally burst into untethered rants with the thesis that conventional farming is the only way. The remaining twenty households are moderately to firmly convinced that our farm will fail. There are two types of people in this category. The moderately convinced chalk it up to the poor economic situation in Serbia. Those who are firmly convinced the farm will fail are actually wanting the farm to fail. I think the truth is that they're dissatisfied with life, and expressing this type of opinion is a way to vent their frustrations. As a result, I conclude that the overall opinion is only slightly in favor of us failing.

In terms of the science of farming, I have not found many discussion partners. There are a few local farmers I can have engaging conversations with. The vast majority of unprompted advice I receive is to switch to conventional farming or quit before I fail. But I take heart because Jeremiah probably faced a lot more negativity when he bought the field in Anathoth (Jer. 32:8-9) while Jerusalem was under siege by the Babylonian army and Jeremiah himself detained by his own people in the courtyard of the guard in the royal palace of Judah.

**END**

# Custom Grates and Grills

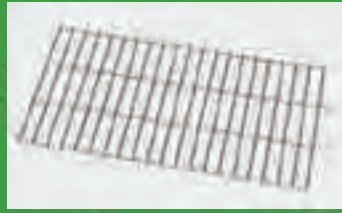
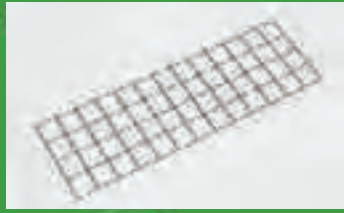

**Our Specialty is Producing wire mesh, grills and shelving. Please contact us today for a custom quote.**

Call and request a free brochure



Call today for your custom quote!

**717.656.0404**

**Fax: 717.656.9417**

**Lancaster, PA**

Manufactured in the U.S.A. 

**WE HAVE FULL PRODUCTION CAPABILITY.**

- POP Displays
- Wire Grill Related Products
- Display Racks
- Stainless Steel Barbecue Grill Racks
- Custom Grids, Mesh, and More!

**Our facilities are capable of handling large quantities of custom wire grids.**



## Automatic Washing Machines

### Solar Powered Automatic 24 volt DC Washer Ideal for off grid homes

- Operates on 24 Volt DC power.
- 3.3 cubic feet of space in drum.
- Bleach and fabric softener dispensers.
- Gentle power agitator reduces wear and tear.
- 3 water and temperature settings.
- 710 RPM spin speed removes more water to reduce drying time.
- 1-340 watt panel and 2 batteries provides approximately 12 loads without charging with sunshine.



**NEW...**

Washer can also be powered with cordless tool batteries 2-12AH can do 2-4 loads of laundry per charge.

### Air Powered Automatic Washer Operates entirely on air pressure

- Operates entirely on 45 - 60 lbs. air pressure, no other power source.
- 3.3 cubic feet of space in drum.
- Automatic cold rinse standard.
- Bleach and fabric softener dispensers.
- Rotary controls make it simple to set cycles.
- 3 water temperature settings.
- 710 RPM spin speed removes more water to reduce drying time.



**Fisher Manufacturing • Narvon, PA • 717.768.0155**  
**Call for a dealer in your area • Dealer inquiries welcome.**





**CORDLESS HAND MIXER**

This Mixer is perfect for mixing cookie dough, creams, puddings, meringues, etc. Has 7 speed settings. Very powerful! Built in lithium ion battery.



**Humidifier / Diffuser 1.5 Liter**

**Very Large.** Operates on power tool batteries, Adjustable moisture output. Also has 7 different night light colors. Essential oils can be added directly to the water.



**Upgraded Bender Blender**

Operated by tool batteries Includes coffee grinder and travel bottle. Several upgrades have been made to improve this blender, making it higher quality.



**Battery operated hand Warmer**

Long lasting, built in battery rechargeable via USB, has 3 heat settings, features a USB port for charging other devices. Great for carrying in your pocket.



**Motion Sensor Closet / Cabinet Lights**

These lights have an exceptionally long-lasting battery, motion sensor will turn the light on only when needed, or can be set to always on. It's a great light for a wide variety of applications.

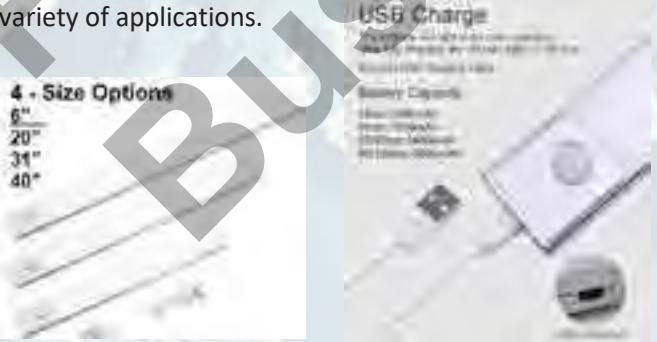

**Massager, Battery Operated** Operates on Power Tool Batteries, or Electric. Incredible deep tissue kneading, with heat, for Neck, Back, Stomach, Arms, and Legs! Amazing Results! Includes carry bag.



**We have many more products available. Please contact us for more information. Ask for a free catalog.**

**DEALER INQUIRES WELCOME**

**Phone # 234-806-8515**



# WIDE CUT TRU-CUT BANDMILLS

**NEW!**

Sawmills are now available  
with 26" deep throat  
for quarter  
sawing!



Available  
in 70" & 96"

## TRU-CUT SLAB SURFACERS



2909 Ky Hwy 3246, Crab Orchard, KY 40419  
**(606) 355-2894**



PCBE-2021-4

Leave Message Today to Receive an Info Packet! Discover how to turn those huge logs into profit!

# Hillside LTD. HARNESS HARDWARE

4205 Township Road 629 • Millersburg, OH 44654

## INTRODUCING



90 DAY

### Elima-Sore

An All Natural Supplement designed to help with equine soundness such as muscle soreness, dry joints, stifle issues, foundered, kidneys and azotemia.



90 DAY

30 DAY

### Elima-Worm

A Natural Daily Dewormer designed to help keep horses parasite free the natural way. Also has ingredients such as "Reed Sedge Peat" to help clean out toxins that don't belong in a horse's body.

## Schwartz Farrier Supply



Horseshoes



Nails



Farrier tools



Aprons



Anvils



Forges



Hoof Care Products.



Drill Tec



Horse minerals



Wormers



Shoeing Boxes

We stock leading brands such as St. Croix Kerckhaert Capewell and more.

For more products call or write for free catalog.

2194 S US Highway 27, Berne IN 46711

**574-642-1250**

## Rockvale Repair



RR-1500 – JANOME  
HD-3000 Electric Sewing Machine

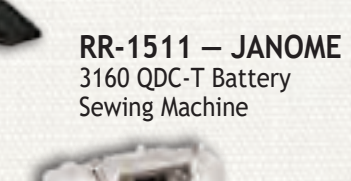

RR-1511 – JANOME  
3160 QDC-T Battery  
Sewing Machine

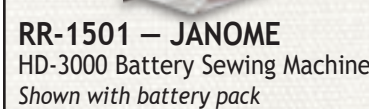

RR-1501 – JANOME  
HD-3000 Battery Sewing Machine  
Shown with battery pack



RR-2003 – 20V DC MOTOR KIT  
Ideal for flatbed treadle machines

Ask for a Free Catalog



Available in Milwaukee (Milwaukee or DeWalt Battery)

Please specify what battery adapter you need

320 Fulton View Road  
Quarryville PA 17566  
717-664-5223

## Rockvale Repair



# UNPLUG your phone service and get the **BLACKBOX!**

- ✓ For home or business
- ✓ Does not require internet
- ✓ No contracts - cancel anytime
- ✓ Quick and easy setup
- ✓ Personal support
- ✓ Supports faxing
- ✓ Keep your existing number
- ✓ Includes Call Waiting, Caller ID and Voicemail



CAN BE HOOKED UP TO 12 VDC OR 110 VAC

**200 MINUTES INCLUDED**  
\$9.99/mo

**UNLIMITED CALLING**  
\$24.99/mo

PLUS THE COST OF THE BLACK BOX (\$100) AND \$10 SHIPPING

## PLAIN FLIP PHONES ALSO AVAILABLE

**SIMPLE, PRACTICAL** cell phone service without the distractions of modern devices

- ✓ NO Wi-Fi or internet
- ✓ NO games
- ✓ Texting and camera (can be removed)
- ✓ Photo messaging available
- ✓ Plans start at \$9.99/mo



Serving the  
Plain Community  
since 2001

Call **WALMER COMMUNICATIONS** today!  
717.850.3910 or toll free at 1.888.853.9244



Wholesale Supplier of Outdoor Cooking & Camping Supplies



**FAMILY  
FIRESIDES**

2300 Force Road, Shreve, OH 44676  
Ph: 330-988-8120 • Fax: 330-403-4432  
Email: sales@familyfiresides.us  
www.familyfiresidesinc.com

**Dealers Welcome**

Please contact us for catalog and pricing.

DROP SHIPPED TO YOUR CUSTOMER OR SHIPPED TO YOUR STORE



**Small Engine  
Get Together**

Feb 12<sup>th</sup> @8:30 AM.

**Everyone welcome!**  
Would appreciate reservations.

**Lengacher Small Engine**  
21984 Heather Rd Keosauqua IA 52565.  
319-293-3754



Increase Profits By  
Feeding TMR!

Vertical Stationary  
TMR Mixer

**FREE BROCHURE!**

1.800.436.5623

← I.H. **RISSLER** →  
— TMR MIXERS SINCE 1981 —

**Every Business Can use Our  
Products & Services**

Printed  
Business  
Forms

Full Color  
Black & White

Signs &  
Banners

Large or Small  
Temporary or Permanent

Promotional  
Products

Thousands of Products  
to Carry Your Message  
to the Public

Engraved  
Plastic Signs

Business, Direction  
Safety & Mfg.

Calendars

Your Ad Seen Everyday  
365 Days a Year

Self-inking  
Stamps

Razor Sharp Impressions  
Fast Turn Around  
Non-Fade inks

**FREE  
Promotional  
Booklet**

McKinley Advertising, LLC  
229 Lakeview Hts. Dr. Howard, OH 43028  
740-397-7305

# PORTABLE PHONE UNITS & LED LIGHTING



## G450PCB

- This handset is small, slim, durable and packed with features such as -500 contacts, Bluetooth, keypad lock, vibrate, alarm clock and more
- Built-in 8 volt battery pack with more than one day of storage
- Charge the unit with 12 volt or electric



## G450PCDE

- This kit has the same handset as G450PCB
- Available with Dewalt, Makita, or Milwaukee adapters
- 4 Amp battery has enough storage for one day runtime



## G630PCB

- Very durable handset. 200 contacts, vibrate and key pad lock
- Phone, Black Box, battery, and components mounted in hard-plastic water proof 9" x 7" x 4" case
- Built-in 8 volt battery pack with more than one day of storage.
- Charge the unit with 12 volt or electric



## G630PCDE

- This kit has the same handset as G630PCB
- Available with Dewalt, Makita, or Milwaukee adapters
- 4 Amp battery has enough storage for one day runtime

## 65 watt Super-Bright Hanging Work Light!

Works great for stores, shops, and Wedding Houses!

- 100% Dimmable!
- Built-in 7-day Timer!
- Hang-up or Set-down Design!
- 9750 Lumens of White Light!

Works with the following Tool Batteries:

- Dew/Mil combo
- Makita

Approximate Runtimes on 2 9ah Batteries:

- High: 5.2 hrs
- Med: 12 hrs
- Low: 65 hrs

**Unique Remote Control with dimmer and 1 mile range now available!**



## Are You Tired of Dropping Calls all the Time With Your Existing Black Box?

Try the Net 10 Home Phone Device!



We have tested these in numerous states across the US and have found they have better service than most other carriers. Net 10 leases the towers from the 4 main service providers, therefore their service is more consistent all over. Also the black box design is much better than Verizon resulting in less dropped calls while traveling. Service is cheaper as well at around \$20.00 per month total (including taxes and surcharges!)

**Daylight**  
**POWER SOLUTIONS LLC.**  
*Your Source For Renewable Energy Systems*

CALL TO REQUEST A BROCHURE

95 Willett Street, Suite 1  
Fort Plain, NY 13339

phone: 518-332-8151



## VENDORS WANTED

### MIDWEST Health & Wellness EXPO

**January 28 & 29, 2022**

Friday 9-6 & Saturday 8-2

**AT THE MICHIANA EVENT CENTER (MEC)**

455 E Farver St, Shipshewana, IN 46565

**APPLY  
TODAY!**

*In conjunction with the  
Midwest Tool Expo & Auction*

**Nov. 23, 2021**

Early deadline for a chance to win  
a FREE booth at the 2023 expo!

**Dec. 13, 2021**

Registration and ad deadline  
(Payment Due with Reservation).



Sponsored By: *Tension  
Tamer*

**EXPO:** Ervin Miller • 260.768.3033 Fax: 260.768.3133 • Ervin@ESWoodCreations.com

**AUCTION:** Robert Mishler • 260.336.9750 • Robert@schraderauction.com

[midwesthealthwellness.com](http://midwesthealthwellness.com)

## VENDORS WANTED

**January 28 & 29, 2022**

Friday 9-6 & Saturday 8-2

**AT THE MICHIANA EVENT CENTER (MEC)**

455 E Farver St, Shipshewana, IN 46565

### MIDWEST Tool Expo & Auction

**Nov. 23, 2021**

Early deadline for a chance to win  
a FREE booth at the 2023 expo!

**Dec. 13, 2021**

Registration and ad deadline  
(Payment Due with Reservation).



Sponsored By:



**EXPO:** Ervin Miller • 260.768.3033 Fax: 260.768.3133 • Ervin@ESWoodCreations.com

**AUCTION:** Robert Mishler • 260.336.9750 • Robert@schraderauction.com

[midwesttoolexpo.com](http://midwesttoolexpo.com)

*Serving our customers with respect and integrity...*



**Dogwood Ridge  
OPTICS**  
4253-PCBE Woodcock Ln, Dayton, VA 22821

**1-540-947-1636**

...and  
we strive  
to respect others  
in the optics business.  
Please help us by not asking  
us to under-cut our friends.

Binoculars • Blind • Gun lights • Headlights • Microscopes • Range-  
finders • Riflescopes • Solar Scopes • Spotting Scopes • Telescopes

Alpen • Bresser • Celestron • Coronado • Explore Scientific • Meade  
• Night Eyes Lights • Scope Buggy • Sky-Watcher • Vortex

**SELLING PRODUCTS**

**Sunrise Enterprise**  
QUALITY COATING PRODUCTS

**Aluminum Roof Coatings**

**Blacktop Maintenance Products**

**Cement Patch and Repair**

**Kiln Sealers**

**Dealers Wanted**

Days: **989-550-1999** • After 6:00PM: **989-872-5216**

**\$169<sup>00</sup>** Each  
PA residents add 6% Sales Tax.

**Easy Push  
Garden Cultivators**  
16" Metal Spoke Wheel

**\$24<sup>95</sup>** Shipping per  
Cultivators  
West of Mississippi River  
including WI and IL

**\$34<sup>95</sup>** Shipping per  
Cultivators

**Cultivator Features**

- Hardwood Handles
- Solid Rubber Wheels with Ball Bearings
- Heavy Duty Tines are Heat Treated and Hardened for Long Wear
- Powder Coated Frame
- 12" Wide
- Built Very Sturdy
- Very Easy to Push

Horse Hitch Optional **\$18<sup>95</sup>**

Row Marker Optional **\$18<sup>95</sup>**

**Dealer Inquiries  
Welcome**  
Call or Write for Prices

**PEACHEY'S Sharpening and Sales**

2437 E. Valley Road | Loganton, PA 17747 | Phone: 570.725.2387  
Leave Message or try calling 8:00 to 8:15AM Mon. thru Fri.

**FOR SALE**

**2019 Bobcat MT85**

Works Great  
**\$26,500<sup>00</sup>**



• 583 hrs.                      • 850 lbs. Operating  
• New engine at 569 hrs.      capacity

**217-982-9074**

## Silverline

# CIDER PRESS

Check out the  
**NEW Silverline  
Clothes Line  
System**



Suitable for Basements, Porches, Entrances, Overhangs, Shops, Wash houses or wherever else needed. Designed

for ceilings from 7-9' high. Now XL size available for up to 10' ceilings. All hardware and installation instructions included.

Economy Laundry Cart  
Lightweight aluminum cart;  
flat free rubber wheels

**Dealer Inquiries Welcome**



Laundry cart	\$ 94.00
Silverline System	\$495.00
Silverline XL	\$515.00
Vinyl Coated Cable 150'	\$ 55.00
Vinyl Coated Cable 250'	\$ 85.00
Center hanger, required at 30'	\$233.00
Center hanger XL, required at 30'	\$244.00



- 30 gal. per hour Capacity
- 220 Volt Electric Motor (30 amp)
- Hydraulic Press
- Heavy Duty Casters with Brakes
- 10" Stainless Steel Chopper
- 16" Plastic Slats
- 34" x 34" Press Cloths
- Optional Flex-Shaft Hookup

*Kuhns Welding*



"Your Satisfaction is our Goal"

Free Shipping on all above products  
Indiana Res. Add 7% sales tax

10101 Shively Rd.  
Nappanee, IN 46550  
**574-862-4592**

# ENERGY EFFICIENT APPLIANCES

designed to save power and money

*Available at your local solar installer*

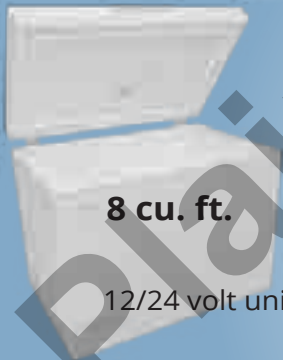

**8 cu. ft.**

12/24 volt unit

**More sizes & models available**

### MODEL ST-8CF FREEZER

Features:

- 4.5" insulated walls
- Double lid gasket
- Interior lid light
- Air cooled condenser for fast cool down
- Coated steel interior for aesthetics and easy cleaning
- Two in one thermostat (refrigerate or freeze)
- Portable. Heavy duty casters on each corner

### MODEL ST-15CF AC FREEZER

Features:

- 4.6" polyurethane walls
- Double lid gasket
- Interior lid light
- Air-cooled condenser for fast cool down
- Coated steel interior for aesthetics & easy cleaning
- Two-in-one thermostat (refrigerator or freezer)
- Portable, heavy-duty castors on each bottom corner

**New Product**



**15 cu. ft.**

115 volt unit

This unit, like the rest of our models, is extremely energy efficient. Regular power draw is less than 1 amp.

**SPECIAL ENGINEERING AND INVESTMENTS have been made to build these units as ENERGY EFFICIENT as possible.**



**SOLAR FREEZE, LLC**

Now made in the U.S.A.

Phone: 260.499.4973  
Fax: 260.499.4984



# YODER CONNECTIONS

CALL 833-4YODERS  
(833-496-3377)  
Fax: 888-435-3203  
Text: 304-661-1559  
22212 Galaxy Rd.  
Maryville, MO 64428

Email: Kevin@kyoders.com  
Support@kyoders.com  
Hours—7 AM—5 PM (CST)  
Monday—Friday  
Ask for a free brochure!

**YODER GUARANTEE!**  
14-Day Satisfaction Guarantee  
Like it, or return it!  
If you're not satisfied,  
we're not either!

## Cell Phones

Specializing in internet-free phones

**Best Selling**



**Great Value**



**Ultra Rugged**



**New**

**Sunbeam**  
Three Models

1. Talk only
2. Talk and text
3. Full featured with weather and maps

**"Dumb" Smartphones Locked to your specs**



## New desk phone!

**Desk phone and black box in one!**



**\$139**  
\$20 / month (AT&T)  
Two options:  
Talk only  
Talk & text  
Text from a desk phone!

## New—US Cellular!

**Phones**  
LG Wine 2 - Sonim XP-3  
**Plans**  
Unlimited—\$29 / month  
Itemized billing available  
Free calling to Canada & Mexico  
Coverage in most areas

## Hotspots

Wifi hotspots—can lock to email only  
Tablets—with secure lockdowns  
Data plans  
Verizon / AT&T

## Home Connect (Black Boxes)

\$17-\$20/month—unlimited calling  
Plus taxes and surcharges  
**Works for fax machines!**  
Verizon - AT&T - Straight Talk



## Cell Phone Plans

- Monthly plans start at \$12
- Unlimited plans start at \$20
- Annual plans start at \$75 (for Verizon & AT&T)

## Phone Kits

1. Choose your case: Briefcase, Waterproof, Compact
2. Choose your phone: Corded or cordless Standard or long-range
3. Choose your battery: DeWalt/Milwaukee adaptor Or our battery—5 yr. warranty
4. Choose your black box Verizon / Strait Talk / AT&T

## Home/Office Phones

**\$41**  
**\$58** **\$199**  
Many phones & brands  
EnGenius, Gigaset, Panasonic, Vtech, AT&T

## Boosters

**\$399**  
For cell phones and black boxes



## For All of Your Metals, Salvage and Surplus Needs

15 Acre Yard, 58 Hartz Road, Fleetwood, PA 19522  
 Open Monday through Friday, 7 AM to 4 PM  
 Saturday, 7 AM to Noon

Cash and Major Credit Cards Accepted (610) 921-8848

We ship UPS  
 ground and motor  
 freight in the USA  
 and Canada

Directions from Lancaster: Take US Route 222 North toward Reading. In Reading, take no exits, US Route 222 becomes US Route 12 East toward Pricetown. On PA Route 12 East go 8 miles, turn left at PA Route 73 Blandon Road at Redners. On PA Route 73 go 1/2 mile, turn left on Hartz Road. On Hartz Road go 1/4 mile, look for green/beige metal fence on right, 58 Hartz Road.

**Help!! Help Wanted!! Help Wanted At Industrial Salvage & Metal Yard, Multiple Positions Available, Call For An Interview.**



**New 20 LB Propane Tank Storage Rack**, Capacity: 9 Tanks, 50 + Racks Available, Great For Hardware Stores, Supply Centers, Campgrounds & etc. **\$150.00 Each**



**WESTERN GLOBAL ENVIROCUBE E250 5,629 GALLON FUEL TANK**, UL Listed 142, New in 2019, Great for Construction Sites & Etc, 2 Available, **\$19,000.00 Each**,



**Heavy Steel Culvert Pipe / Steel Pipe Bridge Tunnel Pipe**, 6 Pieces Steel Pipe w/Bolt Together Flanges, 84" ID x 129" Long, **\$3500.00/OBO**



**6061 Aluminum Sheet**, 190" x 48" x 96", 500 sheets available, **\$216.75 Per Sheet**, \$2.50 per lb, **43,000 LBS 3003 1/8" Aluminum Sheet**, Various Size Sheets, 4' x 6', 4' x 10' 5' x 8' & ETC. 1/8" weighs approx.: 1.7 lbs per sq. foot, **\$2.50 per lb.**



**John Deere 6081 Diesel 150DSJ 150 Kw. Diesel Backup Generator**, 188 KVA, John Deere 8.1L 250 HP Diesel Engine, with Loadtec Load Bank Controller, Disconnect Switch, 150 KW Bypass Switch, **\$18,000.00**



**Deka AVR Unigy II AVR 9533 Batteries**, 12V Battery System (6 Batteries), 1520 AH, No Wires, 12 Systems Available, 2 or more systems can be combined for 24V and/or additional storage, **\$1500.00 for a 12 Volt Set**,



**New Aluminum Diamond Plate**, New 1/4" x 5' x 10', Approximately 14,000 lbs, 81 Pieces @ \$2.50 /lb, Approx. **\$462.50 Per Sheet**



**Fiberglass Cone Bottom Tanks**, 2-4000 Gallon Fiberglass Tanks w/ Cone Bottom, **\$2000.00 Each**, 2-7000 Gallon Fiberglass Cone Bottom Tanks, **\$3500.00 Each**,



**Peerless Cast Iron Boilers**, Model# 211A-10, Gas Fired Steam Boilers, Input MBH: 1890, 40 Boiler HP, 2 Available, **\$7000.00/OBO**



**Concrete Retaining Walls / Foundation / Bunker Trench Silo Walls, Concrete Barrier Blocks**, 40' Long x 60" Wide x 24" Thick, 60,000 lbs, 17 Available, Call Our Office For More Details,



**New Wall Brick / Paver Brick**, Approx 1,200,000 Brick Available, **\$.20 Per brick for Wall Brick & \$.30 per brick for Paver Brick**,



**19-W-4 Welded steel Bar Grating**, 1.25" H x 3/16" Bar , 20" x 18'-24' long, **9.03 lbs per sq ft, \$5.87 Per sq Ft**

**PARA CLEANSE WORMER** - \$5.00 per oz. \$4.00 per oz. for 16 oz. or more (2 oz. per adult - children 1/2 dose)  
**WHOOPING COUGH TINCTURE** - Will only have a mild case if this taken. \$2.50 an oz.  
**CANNIBAS OIL** - CBD rich, 2 oz. bottle \$32.50  
**SPRIGS SUPER GREEN** - 9.5 oz. for \$22.50  
**SPRIGS KIDS GREENS** - 9.5 oz. for \$18.00  
**SISEL BRAIN VITALITY** - \$60.00  
**SUPER OMEGA PLUS** - \$65.00  
**ZIPPY GREEN** - more energy. \$12.00 for 200 capsules or \$18.00 for 1 lb.  
**DE-PAIN** - High potency, natural pain relief. \$25.00 for 90 capsules  
**HAARLEM-OIL** - Good for Lymes. 120 capsules for \$45.00

**BARLEY GREEN** - Immune Booster. \$12.00 for 200 capsules or \$16.00 for 1 lb.  
**COMPLETE TISSUE** - Stronger bones, flesh, cartilage. Please specify with or without comfrey. \$12.00 for 200 capsules or \$16.00 for 1 lb.  
**HAARLEM-OIL** - Livestock. \$39.00 for 8 oz.  
**EMPTY CAPSULES** -  
 1,000 count — size 00 vegetable ..... \$12.00  
 1,000 count — size 0 vegetable ..... \$10.00  
**ENZYMES (Papaya & Bromelion)** -  
 200 count ..... \$12.00  
*We also carry the dry herbs and also tinctures of single herbs. Please add \$10.00 for Shipping and Handling for any size order. KS residents add 7.0% tax.*  
*These product have not been evaluated by the FDA to treat cure or diagnose any disease.*

NEW ADDRESS

### HERBAL BLENDS

2487 Jayhawk RD, Beattie, KS 66406 • 785-353-2420 voicemail

## Custom-Fitted Arch Supports



- Helps relieve back pain, sore feet & heal spurs
- 3/4-length
- light-weight

We will send you a foam block. Simply make a foam imprint of your foot, & send it to us!

Harvey S. Martin Orthotics 717-354-0159  
 555 N. Railroad Ave., New Holland, PA 17557 (formerly Dangler & Williams)

## PUMPKIN VINE PRODUCTS

15677 CR 26 • MIDDLEBURY, IN 46540 • 574-533-5061

**THE DELUXE TRAP for Sparrows & Starlings** \$75 + \$30 Shipping & Handling

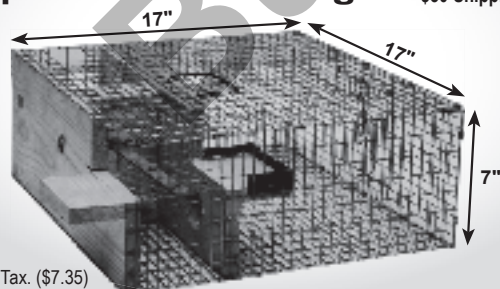

\*Indiana Residents Add 7% Sales Tax. (\$7.35)

Send check with order, Will ship ASAP.

## Mil-Tek RUBBER

- Die Cutting
- Rubber Molding
- Extrusions
- Sheet Goods
- Gaskets
- Door Gaskets

Manufacturer of Rubber Products

100 Factory Street • Baltic, OH 43804  
 ph. 330-852-4009 c. 330-432-8689 f. 330-897-2224  
 email gasketsgalore@yahoo.com • www.miltekrubber.com



Need to do inventory? Need to track sales?  
 Want to create customer profiles?  
 Want to combine your cash register, time clock,  
 and credit card machine?

**Try one of our all-in-one POS systems!**

(You do not need internet!!)

All of our POS systems offer touchless payments!



**We do all kinds of payment processing to get you paid!**

- » Need check guarantee? (never get a bad check again!)
  - » Need recurring billing or offer your customers' payment plans?
  - » Need to take payments on your website or would like to set that up?
  - » Need a way to take payments on your mobile?

**Want to eliminate 100% of your credit card processing fees?**

No monthly fees, no annual fees, no fees at all!  
 Our patent program allows you to save 100% of your credit card processing fees!

We offer FREE standard processing equipment to all of our clients (and free credit card paper too!!)



**As With All JadaPay Accounts**

- NO CONTRACT OR LEASES
- GUARANTEED RATES FOR LIFE OF BUSINESS
- We do your PCI for you to guarantee compliance
- Free credit card paper
- Direct customer service and tech assistance
- FREE Standard Terminal Placement
- FREE Gift Card Service

**BULK FOOD STORE/ GROCERY EXPERTS (multi-lane, EBT, cash discount, POS, etc.)**

**Need Wireless?**



Our machines run on AT&T or Verizon  
 We have smart and non-smart machines

From speciality retail stores to hardware/lumber yards and restaurants to online stores, we do it ALL!

**MINI BARN/SHEDS/ OUTDOOR FURNITURE EXPERTS**  
 From 1-100 lots, we got you covered.  
 Wireless, customer tracking, multi-location processing, etc.  
 \*references available!

Need more than wireless? Use a black box only for a phone line?  
**TRY WIRELESS DATA with a JADAPAY box! Locked down, no website access!**

**Gets you a faster connection without internet!**

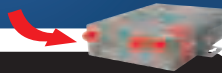

Heartland  
 North American Bankcard  
 Elavon  
 TSYS  
 Retriever  
 Your local bank  
 Central Payments  
 First Data

*If you use one of these companies for your current processing, we guarantee a minimum savings of 10% or will give you \$500 cold hard cash!!!!*

Need to create a social media page?  
 Need help creating commercials/ads to draw in customers to your location?  
 Need help creating relevant and new content?  
 Need help creating or maintaining a website?  
 Would you like to accept payments through your website?

We have over 20 years of social media/website creating and maintaining experience.



**We can help!**



**FAX: 812.705.7220**  
**JOHN PAUL DAVIS**  
 (NATIONAL):  
**502.533.5929**  
**JP@JADAPAY.COM**

**FAX: 319.409.9998**  
**MERVIN YODER**  
 (CENTRAL/EAST):  
**317.512.8459**  
**MERVIN@JADAPAY.COM**

**FAX: 877.791.4971**  
**WENDELL MARTIN**  
 (WEST):  
**360.791.8483**  
**WWW.JADAPAY.COM**





# DOUCET



With 3 models of drying racks you can find the right one for your needs. The Eco-Flex Drying Rack can be adjusted between 200 mm and 1500 mm. The Varioflex Drying Rack can be adjusted between 200 mm and 2000 mm. The Staviloflex Drying Rack can be adjusted between 300 - 2000 mm

The DWM Drawer Master assembles drawers with standard finger-type dovetails, sliding-type dovetails, bored and doweled drawers, and tongue & dado box joints. Features an ergonomic workstation suitable for assembly of your boxes directly in the clamp.

The EF-12SR is the smallest member of the Cresswood's "Destroyer Series" product line. It will eliminate rippings and occasional blocks. The EF-12SR grinder, with its small footprint and low profile, allow placement of the grinder in close proximity to the waste stream which saves labor. This is the ideal wood grinder for small furniture, cabinet, and woodworking and millwork shops.



CANTEK R-18 with out motors \$19,695



Surcare SMF-V4 Micro-Finisher. \$1,889.99



Safety Speed SPM301 Pocket Hole Machine \$5,699



MB RB300N-BAG Two sided molding sander \$99,500



14107 Used Unique Raised Panel Door Machine Model: GT250 Year 2005. Motor: 10HP Direct Drive Stacked Spindle; 1-1/4" Diameter; 5-1/4" stacking capacity Air required: 90psi \$15,900



14097 Used Denray 9600 Down Draft Table. This model is ideal for larger jobs, as well as accommodating to two or three jobs going at the same time on the table. The 9600 can be used for plastics, woods and finishing materials. \$7,300



14095 Used Edgetech CTS-730 Miter Saw. Integrates cutting off and/or mitering self edged tops, postformed covered tops, or solid surface countertops, making both a mitering cut and draw bolt mortises in one simple cycle \$5,000



13408 Used Oliver Model 299T 24" Planer With ITCH Spiral Head 7.5 HP, 208-220/440 volt. Wired 220V 3 phase 24" wide capacity; 8" Max thickness Variable feed speed, 25 to 100 fpm Power driven adjustable height bed rollers Knife grinder included \$11,500



13943 Used SCM SuperSet 23 Plus Moulder. 6 Head Moulder. Head Configuration: Bottom Right Left Right Top (9 HP each) Bottom - (17.43HP) Feed Motor 8.85 HP \$25,000



13755 Used Accu-Systems Model HPJ-48 Bore & Dowel; X Axis CNC control for positioning 15" industrial swivel color touchscreen for creating and selecting programs 2 zones 8 clamp units \$11,900

# HERMANCE

Machine Company

A Division of Würth Baer Supply

178 Campbell Street Williamsport, PA 17701

Phone: (570) 326-9156 Fax: (570) 326-0131

[www.hermance.com](http://www.hermance.com)

[sales@hermance.com](mailto:sales@hermance.com)



800-362-9332



www.mcpackage.com

**IF YOU STRAP IT, WRAP IT, OR PACK IT**

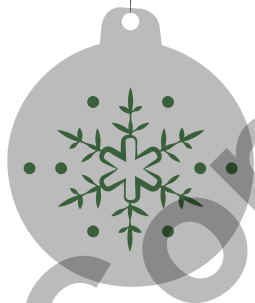

*Call for more information!*

**WE HAVE  
A GIFT  
FOR YOU!**

12-21 ©

P.O. Box 7552, Tifton, Ga 31793 • 108 E. Ogeechee Street, Sylvania, Ga 30467 • P.O. Box 277, Ailey, Ga 30410

**Attention Wood Workers**  
Epoxy-Metallics-Burls  
**Custom Wood Creations**  
625 Mt. View Ln.  
Pearisburg, VA 24134  
(540) 235-1525  
Fax: (540) 921-2421

Burls available in the following species:  
Redwood, Buckeye, Claro Walnut, Myrtle, and Big Leaf Maple  
*Call for pricing*



**Metallics available in:**  
Red, Green,  
Blue, Black, White,  
Silver, Coffee,  
+ more!  
*Call for pricing*



**2-Gallon Epoxy Kits**  
**\$125**

COMING SOON

# TOOL BATTERY IRON



American-Made, All-Metal Construction.  
**PLEASE INQUIRE:**



8241 TOWNSHIP ROAD 601, FREDERICKSBURG, OH 44627

## JAMISONS Sharpening Inc.

*Sales and Service of Woodworking Tools*



**Saw Blades**  
Precision sharpening on late model CNC machinery



**Spiral Router Bits**  
We sharpen both flute and OD on CNC grinder for optimum performance



**Custom Profile Knives**  
Corrugated Back and Williams & Hussey knives from wood sample, sketch, or CAD drawing

Since 1988

*We also stock a wide range of new tooling*



**5630 Grandin Road Ext.**  
**Roanoke, VA 24018**  
**540.989.2744**

**LOK General Store LLC**  
**Sewing - Cleaning & More**  
*Everything a women needs to keep her home in order!*  
Over 30 different models of Sewing Machines in stock.



**Cordless Vacuums.**



**Customer Favorite**

**Harmonicas**



**Sewing Machines & Sergers**

Treadle, Cordless, or Electric. Mechanical or Digital. The best brands in the industry.



**SIRENA**  
Total Home Cleaning System.  
Water-based Filtration.  
FREE oils with purchase!

**Call or write to place orders or request a FREE catalog.**

**LOK General Store LLC**  
623 W Elnora St., Odon, IN 47562  
Phone: 812-636-0196







**RE-COILING**  
SLITTING & BLANKING

**METAL**  
**EXTERIORS**  
CUSTOM METAL ROOFING AND SIDING

**Now Offering  
Re-coiling  
Services!**

**Specializing in job lot coils**

**No more left over coils**



- Slitting - For all your custom width coil needs.
- Re-Coiling - For cut to the inch job lots.
- Blanking - For all your flat sheet needs.
- Edge transfer - For coil edge issues.
- Paint reversing - For paint down panel forming
- Standing Seam & Board-Batten coils.
- Prints and Wood Grains available.
- We can get custom colors painted.
- 35 Sherwin Williams colors available.
- Embossed and Perforated coils.

**We specialize in shipping job lot coils via LTL for your standard and specialty coil needs.**

# Alaska's Sitka Blacktail Deer

By Matt Snader



In last month's article I wrote about the largest deer on the planet, moose. This month I will write about a much smaller deer, the Sitka Deer. I will also clear up some confusion about Alaska Sitka deer versus the Sika deer found in Maryland. Both versions of these deer are smaller than whitetail, causing me to initially think they were the same subspecies of deer. Hoping I could call the article *The Smallest Deer of All*, I was surprised to find both Alaska and Maryland Sitka are not anywhere close to being the smallest deer on the planet. Note for the purposes of this article I will use the terms Sitka deer and blacktail interchangeably, and Sika is the proper spelling for the Maryland version.

The smallest deer species is the Pudu, which doesn't look at all like a traditional deer. These funny little creatures live in Chile, and are also called Chilean Mountain Goats,

despite having nothing to do with the goat family. They do look a little like goats. The heaviest pudu ever recorded was 30 pounds! Most pudu are around 20 pounds. To put that in perspective, some rabbits can grow larger than this deer, such as the Flemish Giant Rabbit. Imagine bringing a deer back after a hard day of hunting, only to discover your buddy harvested a rabbit that was larger than your deer! At least your taxidermy work would be pretty affordable. Ok, let's get back to deer in the United States.

I wasn't even aware that a small species of deer lived in Maryland, until someone stopped in at my house. He pointed to Shane's Sitka deer mount, which is hanging in our living room, and asked something about it. When I replied it was a Sitka deer, he wondered if they were the same as the ones in Maryland. I was stumped. Sitka deer in Maryland? How did they get there? Those questions prompted some research, which I will share with you.

Maryland's deer are actually Sika deer, not Sitka. The sika deer were imported from Asia; a fellow by the name of Clement Henry released five or six deer on James Island. From there they spread to other islands and also the mainland. A large sika buck weights 90 pounds, and a large doe 70 pounds. Antlers tend to be noticeably smaller than whitetail. Maryland Sika deer have very different genetics than an Alaska Sitka Blacktail and are a different subspecies. Now that we have that out of



A Sitka blacktail buck relaxes in the grass. This would be a large buck by Sitka standards.

Image credit: istock Gummybone



the way, let's move on to Alaska Sitka deer.

When I first moved to Alaska, I didn't expect to put any effort into hunting deer up here. Who wants to hunt deer when you have North America's largest animals lumbering through your back yard? I must admit that I had some good logic there, but I wasn't factoring everything into the hunting equation. First-there are a lot more deer per square mile than other big game. Second-Deer are much easier to hunt and process than a 1,000 pound moose or bear. Also, deer are unlikely to charge you and tear you to pieces if you don't hit them properly. Also, the atmosphere of a bunch of guys staying at a cabin deer hunting is just hard to beat. If you want to get to know someone better, take them to Afognak Island for a few days in a dinky little cabin, with no phone service. For example: My cousin Elmer Weaver just flew up last month from Pennsylvania, and we went deer hunting on Afognak Island. I talked more to him in five days than the entire previous decade combined. He brought along his son Gage, who before I could barely remember his name. Not so anymore.

The catch with deer hunting in Alaska is that the deer are limited to islands and coastal regions. That means I can't just hunt them in my backyard, but instead must go to the Kodiak Islands Archipelago, Prince William Sound, or the coastal areas further south around Sitka. Fortunately, Kodiak Island is just a 45 minute flight from my house, so airfare is very reasonable. Most hunters will then take a float plane or water taxi to a remote cabin. There are many public use cabins scattered around Kodiak and the surrounding islands, available for \$35 a night. In theory I could also take my boat to Kodiak from Homer, but I'm a little skittish about going that distance with it (150 miles). With the price of fuel, flying commercial is actually cheaper than taking my boat, plus I don't have to worry about hitting rocks and sinking it.

All these deer running around the Kodiak Islands come

from a small original herd. Around 1920 blacktail deer were brought up from Sitka (hence the name), Alaska, and turned loose. Over the years a few more were introduced to increase genetic diversity. The first deer season was held in Kodiak in 1953, for a six day period. Thirty-eight buck were taken with 200 hunters. The deer have multiplied rapidly over the years. Now the hunting season is approximately three months! During the 2021 deer season in Kodiak, 6,141 deer were reported harvested, which means I personally accounted for 0.05% of the total Kodiak deer harvest! That sounds more impressive than saying I got three deer. An even more impressive number: In 2020 my son, Shane, personally harvested 1.3% of all musk ox taken in Alaska!

Alaska is the northernmost reach of Sitka deer, and the winters can be pretty hard on them. Deep snow is their worst problem, as it makes moving around and finding food difficult. Prince William Sound is as far North as you will find them. The reason you find deer on islands and the coastal areas is because those areas have more moderate climates. Hard winters will make a noticeable dent in the deer population, but they rebound quickly. In 1923 deer were introduced on the Kenai Peninsula, where I live, but sadly they did not last long, as the winters are too severe. There have been deer sightings reported around the town of Seward, which is about a two hour drive from my house.

Readers might remember in my seventh book, *Bears, Prayers, and Airplanes*, we went deer hunting near the town of Cordova. That town is located on the shore of Prince William Sound, and can only be accessed by boat or plane. Hawkens and Hinchinbrook Islands are located nearby, and have healthy deer populations. I was only

brave enough to reach Hawkens island with my small boat, which we had hauled to Cordova on the ferry. Allegedly the Sitka deer are smaller on these two islands. According to local trivia, which I haven't been able to locate a written

*Alaska's Sitka Blacktail Deer - Continued on Page 354*



A Pudu deer found in Chile. These are the smallest deer in the world.

Image credit: istock Fotomicar

*Alaska's Sitka Blacktail Deer - Continued from Page 353*

source, a few whitetail were also turned loose on Kodiak, where they intermingled with the Sitka, resulting in a larger deer. Unfortunately, I don't have much personal experience with comparing deer between the two locations, so I can't say that from my own experience.

Lastly, people ask about the behavior of Sitka verses whitetail. Having grown up hunting whitetail, and spent the last five years hunting blacktail, I feel I can make some good comparisons. The most obvious difference is that a whitetail deer will jump up and run off if you so much as twitch a nostril. Blacktail, on the other hand, will often just watch you shoot at them. If you miss, no big deal! Elmer's son, Gage, even had a blacktail walk into him, and he pushed it away with his hand! I won't say what happened after that, except that deer was removed from the gene pool. While this might make blacktail sound pretty dull minded, I can't help but think that approach may have worked for them more often than I know. They are very sneaky, and often will seem to appear right in the middle of a field! You can also use a deer whistle to attract blacktail, although it never seemed to work very well for me. I'm not aware of anything in use like that for whitetail.

One very possible reason blacktail are not as jumpy as whitetail is they have far less hunting pressure. In the 2020-21 Pennsylvania deer season, for example, over 430,000 whitetail deer were taken by hunters. Compare that to the 6,141 deer from Kodiak-and that is a lot less hunting going on, although Kodiak Island Archipelago is about 1/6 the size of Pennsylvania. Considering that the success rate is much higher in Kodiak, along with higher bag limits, and you have even lower numbers of hunters per square mile than the

initial number of deer taken suggest. Typically I can hunt on Afognak or Kodiak Island for five days without seeing another person outside of our hunting party.

Another possible reason for the resilience of blacktail this far North is the lack of predators. Many of the islands they live on do not have any large animals except for the deer themselves. Notable exceptions to this are the islands around Kodiak, which have Kodiak bears, and the bears love deer! However, it seems that bears will take fewer deer than a wolf pack, so while they might be stalked by a very large predator, overall less of them will be eaten. Eagles and other birds of prey have been known to attack small fawns as well.

I find it amazing that the deer kind are able to thrive in every US state, including Alaska and Hawaii. They are also native to every continent except Australia and Antarctica. They are able to survive in hot and cold climates, and range from 20 pounds to 1,200 pounds. Sitka deer are a good example of the deer species amazing ability to adopt to it's surroundings. I'm glad God built enough genetic diversity into the species to allow them to live in Alaska.

Thanks for reading! ~**Matt Snader**



This is Afognak Island, ideal Sitka deer habitat.

Photo by Matt Snader



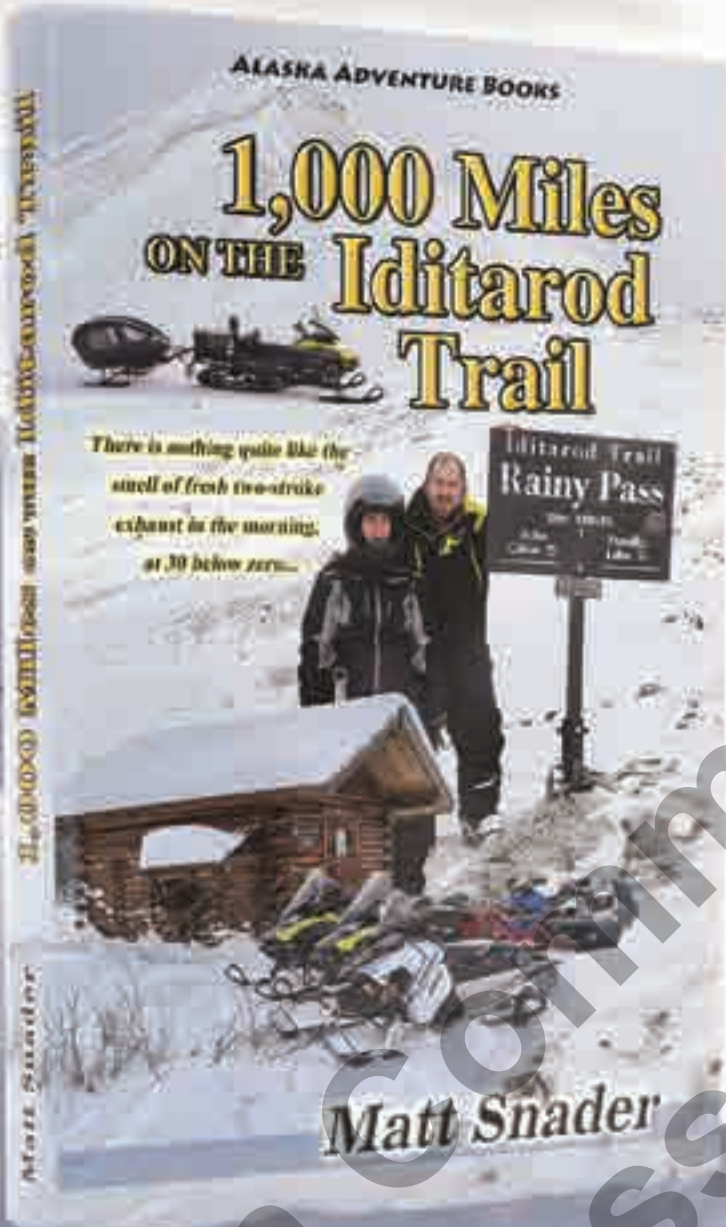

# New Book Release!

by Matt Snader + Alaska Adventure Books

The only way to McGrath, Alaska, during wintertime is by plane or on the Iditarod trail. A fan of the Iditarod dog sled races, and also the Iron Dog snowmachine race, author Matt Snader decides to ride the Iditarod Trail from Willow (where it starts) to McGrath, a distance of 300 miles. His wife and son accompany him, as well as his brother-in-law, Mike. No one in the group is experienced in dealing with Alaska's harsh climate and unpredictable trail conditions. The Iditarod Trail is not a regularly groomed course, like many trails in the lower 48. Hiking through the remote, frozen interior of Alaska can be dangerous. Extreme cold, water overflows on rivers and lakes, wildlife, and mechanical problems all caused challenges. Fuel needed to be limited along, and problems arose as the trails did not match the OPS. On several occasions the group got lost, resulting in them sleeping in a trapper's cabin on one occasion and in a mining camp on another. Due to miscommunication, Search and Rescue, along with a helicopter were dispatched to find the group. Along the way they encounter famous Iditarod mushers, such as Dallas Seavey and Lance Mackey. An interesting read for the whole family!

240 pages + over 100 full-color photos



Book #1	PA to Prudhoe Bay, AK	\$9.99
Book #2	Return to Alaska	\$12.99
Book #3	The Year of Much Fishing	\$13.99
Book #4	The Snader Family Cookbook	\$22.99
Book #5	There's No Place Like Nome	\$13.99
Book #6	Convoy to Alaska	\$13.99
Book #7	Bears, Prayers, and Airplanes	\$16.99

Book #8	Yes, It Snows in Hawaii	\$13.99
Book #9	The Last Flight of the Limo	\$16.99
Book #10	Vikings, Ruins, and Buried Treasure	\$17.99
Book #11	1,000 Miles on the Iditarod Trail	\$17.99
Entire Set (all 11 books)		\$159.00
Last Three Titles Combo (books 9, 10, & 11)		\$49.00

All of Matt Snader's books can be purchased online, or by mailing your order (along with a check) to the address below:

Alaska Adventure Books, PO Box 12, Fresno, Ohio 43824 • [www.AlaskaAdventureBooks.com](http://www.AlaskaAdventureBooks.com) • 330-840-2230 • fax: 717-255-0300

FREE SHIPPING ON ORDERS OVER \$19.00 • ORDERS UNDER \$19.00, ADD \$3.00 FOR SHIPPING

Books also available in stores and catalogs



# Express Wagons



We also build aluminum horse stalls and grill work.

- Heavy Duty Aluminum
- Lightweight
- Rubber Tires
- Pony Hitch Available

Colors Available:

- Red
- Blue
- John Deere Green

"He said it was the BEST PRESENT EVER!"

- Happy Parent



310 Heck Road, Jersey Shore PA 17740  
(570) 745-2240



Little Mountain  
**WELDING**

## Adjustable WALL LEVELER

Put up your walls *FASTER*  
with fewer employees!



Brace  
&  
Level  
AT THE  
SAME TIME!

- Stainless Steel Adjustable Threaded Rod
- Lightweight Aluminum Frame
- Ground Stakes or Bolt to Wall
- 12 ft Extends to 16 ft

Dealers Wanted Throughout the USA - Call Today!



Wholesale and Retail  
**Fire Pit/Grills**



**MERRY CHRISTMAS**  
may we remember the  
reason for this season.



\$40.00

- 300 sq inch grilling surface
- Removable ash tray
- 11 ga steel

USA 610-682-6540  
CAN 519-698-2683



# Bolts & Nuts

Shops and Manufacturing Companies  
Now You Can Buy All Your Fasteners In Bulk

- Grade 2, Grade 5 and Grade 8 Hex bolts
- Grade 2, grade 5 Carriage bolts
- 3' and 6' Threaded Rods
- Set Screws

Available in Zinc and Plain

## Community Supplies

3651 Route 14A, Penn Yan, NY 14527

Phone: 315-536-7049 • Fax: 315-536-9307

email: ezm@ibyfax.com

Dealers Wanted

OVER 30 YEARS IN BUSINESS  
ANY QUESTIONS PLEASE CALL

# Western Woodworkers



IS WITHIN YOUR REACH!!!



## MOSES MILLER

406-366-1147

44 Troyer Lane  
Moore, MT 59464

fax: 406-813-0404  
finaltouch@ibyfax.com

- Conversion Varnish
- Precats
- Easywipe Stains
- Primers
- Paints
- Custom Color Matches
- Glazes
- Burnishes
- Crackle
- 2K Urethanes
- Epoxies
- Waterbase Varnishes
- UV Cure Finishes
- Brushable Polyurethanes
- Exterior Stains



"NO EYE BURN - NO NOSE BURN"  
9938 ARMORVAR ELITE  
9936 RAPID SEAL ELITE  
9937 NF WHITE PRIMER



Shipping UPS and truck freight

Give me a Call and tell me how I can help

Your Success is Our Mission



# Truckload Sale

Simpson Concrete & Masonry Screws

ZINC PLATED WITH CERAMIC COATING

## Hex Head 5/16" Head

- 1/4" x 1-1/4" ..... \$3.45
- 1/4" x 1-3/4" ..... \$4.18
- 1/4" x 2-1/4" ..... \$4.80

- 1/4" x 2-3/4" ..... \$5.90
- 1/4" x 3-1/4" ..... \$8.33

## Hex Head 1/4" Head

- 3/16" x 1-3/4" ..... \$3.25
- 3/16" x 2-3/4" ..... \$4.30

## Flat Head #3 Philips

- 1/4" x 1-3/4" ..... \$4.18
- 1/4" x 2-1/4" ..... \$4.80

- 3/16" x 1-3/4" ..... \$3.25
- 3/16" x 2-1/4" ..... \$3.45
- 3/16" x 2-3/4" ..... \$4.30

Price is per 75 Count

## Included Masonry Drill Bit

Free Shipping \$100.00 Orders  
Orders less than \$100.00  
add \$15.00 Shipping

PA Residents add 6% Sales Tax

Specialize in Scratch - Dent Appliances  
and Discount Building Material

Mail Check or Cash to:  
**Slate Road Supply**



Surplus & Discounted Building Products

Phone: 717-445-5222 150 Slate Road  
Fax: 717-445-4841 Ephrata, PA 17522

M-F 7AM-5:00PM Sat 7AM-11:30AM  
Dolgeville, NY 13329 • Phone: 315-429-3184



# 25 YEARS

## Product Line

- Panel Rollformer
- Pre Cut or Post Cut Shears
- Trim Rollformers, Single or Multi Profile
- Hemmers
- Slitters

## Power Options

- Electric
- 12 Volt DC (battery)
- Hydraulic
- Line Shaft



Product Line Gr Mail  
833-600-0515 4511 N. Freya St  
Spokane WA 99217

# Commercial Racking

**Pallet Racks • Cantilever Racks • Used Gondola Shelving - In Stock!**



**WE HAVE YOUR SHELVING SOLUTIONS!  
DELIVERY AVAILABLE**

## Many Styles of Racking & Shelving

If you are ready to organize and streamline your inventory, let us help you with your shelving needs.



5736 Lincoln Highway, Gap PA 17527  
717.442.9334  
Toll Free: 844.442.9331 Fax: 717.442.2998  
www.SamsMechanical.com



Call for a catalog to see our full line of Allied Products!

**Your Source for shelving to keep your inventory easily accessible and organized.**

See Our Other Ads For FORK LIFT & Skid Loader Info

Visit our website for your parts and equipment needs.

**BASIC FARM & HOME SUPPLY**

Basic products for practical lifestyles. Specializing in hard-to-find items. Free shipping on \$250 orders for most items. Please call or write for a free catalog.

2188 S. US Hwy 27, Berne, IN 46711  
1-866-444-2666 \* Fax 1-260-692-6290

**Are you looking to lose weight, improve high blood pressure, cholesterol, or blood sugars?**

**John lost over 75 pounds**

*In a clinical study, the group on the Optimal Weight 5 & 1 Plan® lost 10x more weight than the self-directed group. Average weight loss on the Optimal Weight 5 & 1 Plan is 12 pounds.*

**John and Charlotte Bauman**  
Independent Certified Health Coaches  
John: 814-329-0014 | Charlotte: 814-414-2653  
jbaumanhealthcoach@gmail.com

**Take the first step to optimal health.**

We make it easy to be free of excess weight, low energy, and poor health!

**Join us, and:**

- Get a **FREE** health coach
- Safe, effective plan
- Get the Habits of Health system

**Call for a free orientation.**

**MIDWEST TURNINGS, LLC**  
DBA HOOSIER PEDESTALS, LLC  
7900 W 650 S • Topeka, IN 46571  
Ph. 260-593-0631 • Fax 260-593-0569

Contact us for a **BROCHURE**

**SHAVING SAVER**  
**STAINLESS STEEL FINGERS W/  
ALUMINUM FRAME & HANDLE**

**NO MORE BROKEN HANDLES  
OR MISSING FINGERS!**

**CALL LARRY FOR  
QUANTITY PRICING**  
**573-539-2134 OR FAX 573-539-0081**



## 2021 Equipment Sellers:

Blanch Flower Lumber	Ebensburg PA	1/22/2021
Strittmatter Turning Mill	Alstead NH	1/22/2021
Yoder Lumber	Millersburg OH	2/4/2021
Raber Ready Cuts	Millersburg OH	2/18/2021
Edwards Forest Products	Talbott TN	2/25/2021
Wright Sawmill	Arlington KY	3/18/2021
Woodland Forest Products	Lake Odessa MI	4/1/2021
Edwards Wood Products	Manning SC	4/8/2021
Equipment Showcase	Middlebury IN	4/10/2021
Missouri Walnut	Neosho MO	4/17/2021
Freedom Hardwoods	Freedom NY	4/22/2021
Northern Wood Products	Walkerton IN	4/28/2021
Ben Troyer	Freemont MI	4/29/2021
Detweilers Wood Products	Knox PA	5/6/2021
JADM Builders	Spickard MO	5/14/2021
Gardner Farms	Williamsport TN	5/15/2021
Appalachian Consignment	Eden NC	5/20/2021
High Country Lumber	Millwood KY	6/3/2021
Robert Fry	Johnstown OH	6/22/2021
Equipment Showcase	Middlebury IN	7/1/2021
Bill Ross Sawmill	Dowagiac MI	7/8/2021
Wildwood Millwork	Goshen IN	7/15/2021
Circle S Sawmill	Harwood MO	7/16/2021
Timber Valley Sawmill	Stanley WI	7/17/2021
Oran Milling	Manlius NY	7/22/2021
Burkholder Lumber	Panama NY	7/23/2021
Menno Hostetler	Seymour IA	7/29/2021
Timber Pro Durant Sawmill	Durant MS	8/5/2021
Travco Lumber	McArthur OH	8/12/2021
Schwartz Sawmill	English IN	8/13/2021
Manual Sawmill	Plymouth IN	8/19/2021
Fayette Forest Products	Scottsdale PA	8/21/2021
Mike Schumacher	White Pigeon MI	8/28/2021
Isaac's Sawmill	Loogootee IN	9/10/2021
Ashley River Lumber	Ridgeville SC	9/16/2021
Cutler Bros Sawmill	Lake Ariel PA	9/23/2021
R&K Enterprise	Addison NY	9/24/2021
Greentop Lumber	Charlotte CH VA	9/30/2021
Equipment Showcase	Middlebury IN	10/1/2021
Acadiana Wood Shavings	Opelousas LA	10/7/2021
Lake Erie Consignment	Middlefield OH	10/15/2021
Huntersville Hardwoods	Huntersville NC	10/19/2021
James RD Sawmill	Mechanicsville MD	10/20/2021
Rossi Group	Winchester VA	10/21/2021
Barnes & Severt Lumber Co	Wilkesboro NC	10/28/2021
Roberts Pallet	Ellington MO	10/30/2021
Showcase Equipment	Middlebury IN	11/12/2021
J Edwards Furniture	Ligonier IN	11/16/2021
Baxter Lumber	Deputy IN	11/18/2021
Shouse Sawmill	Decker IN	11/19/2021
Springville Pallet	Springville NY	11/30/2021
Stanley Ricotilli	Millcreek WV	12/2/2021
Abott Farms & Lumber	Rocky Mount VA	12/9/2021
Gardner & Sons	Union Hall VA	12/10/2021
Graham Lumber	Selmer TN	12/14/2021
Bright Star Equipment Auction	Middlebury IN	12/31/2021

**A HUGE Thank you to our sellers (and buyers) in the sawmill and woodworking industries for making 2021 a great year! We look Forward to serving you in 2022!**

*Merry Christmas!  
And may God's blessing be upon you this New Year!*



**574.825.0704**



- Horse Stall Cleaning
- Lawn and Garden
- Many Other Uses
- Holds 70 quarts Muck Bucket



Muck Bucket Carts

The Muck and Laundry carts are made of 3/4" galvanized tubing, have flat free tires, and a stainless steel axle.

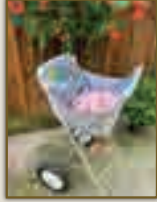

The Folding Laundry Cart

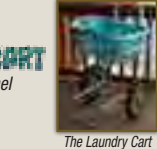

The Laundry Cart



#26 Poly Cart

- 4 Sizes Wood or Poly
- Childs Size available
- Carts Shipped Easy-to-Assemble
- We stock 20", 24" and 26" Heavy Duty Wheels, Can use for pony carts and more!

**Garden Carts**  
Light enough for lawn and garden... strong enough for farm use.

**THE FOLDING LAUNDRY CART**

**THE LAUNDRY CART**

- Holds 1.25 bushel Laundry Basket



#20 Wooden Cart

Ask about our Flat Free Wheels

Dealer Inquiries Welcome

583 Hilldale Road, Holtwood, PA 17532 • 717-284-4177  
www.ConestogaFarmCarts.com

**WATERLESS COOKWARE SETS**  
Lifetime Warranty, T304 Surgical Stainless Steel



- Maxam 17 Pc. 5-Ply Unvented \$325
- Maxam 17 Pc. 5-Ply Vented \$395
- Maxam 17 Pc. 7-Ply Vented \$450
- Lindy's 17 Pc. 7-Ply Unvented \$425
- Lindy's 20 Pc. 9-Ply Unvented \$495
- Lindy's 22 Pc. 9-Ply Unvented \$550

Cookware Sets Dropship to Lower 48 States ppd. 5-Ply Open Stock available.

17Pc. 1.7, 2.5, 3 & 3.2 Dbl, 7.5 Qt. 20 Pc. Adds Skillet, Steamer & Lid 22 Pc. Also Adds 12 Qt. W/Lid



Acu Rite Weather Backlight \$139.99 ppd. LaCrosse Battery Weather \$129.95 ppd.

Metal Detectors: Starting at \$225.00

Optics: Binoculars, Spotters, Riflescopes Tripods, Telescopes & Microscopes

Home, Office, Sport Supply 315-536-8705 2297 Yatesville Rd, Penn Yan, NY 14527



**Premier Doors & Millworks**

www.premierdoorsmt.com



Interior Prehungs Door & Trim

**Knotty Alder \$250.00**  
3/0 PREHUNG

All stock doors are the same price.

WE STOCK

- 2 Panel Arch Top Raised Panel
- 2 Panel Square Top Raised Panel
- 3 Panel Shaker
- 2 Panel Shaker



Any Species Any Profile Blue Pine T&G

PO Box 2411 | Thompson Falls, MT 59873 (2 miles west of Thompson Falls)

phone: 406-544-3956 • fax: 406-558-4800

email: premierdoors@reagan.com

**Schlabach Carriage**

689 Deer Dr. Punxsutawny, PA 15767 (814) 427-2418 ext 1 vm

Ohio Distributor: Quality Signs 390-270-2345

**Ice Block Buckets**

Buy your last buckets first! These forms don't crack when freezing. The ice freezes

into a 12" x 12" x 7" block

Durable & reusable

4.4 gal. 33# block

Stackable

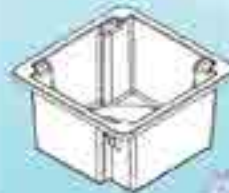

People are so worried about what they eat between Christmas and the New Year, but they really should be worried about what they eat between the New Year and Christmas.

~Unknown



# EtchWood®

2935 N 500 W  
Shipshewana, IN 46565

260-768-7807

[www.etchwood.com](http://www.etchwood.com)



- Custom Beams
- Ship-lap
- Barn Doors
- Planks
- Window Kits
- Commercial
- Plywood
- Floating Shelves
- Countertops
- Wall Boards
- Custom Projects
- Exterior stains



**18 Colors & 6 Textures**

Contact us  
for a Catalog



QUALITY PRODUCTS AT A FAIR PRICE, FOR THE PEOPLE WHO KNOW THE DIFFERENCE

# MICHIANA

## Sales and Service

2021

# Christmas Toy Sale

# 10% OFF

through December 17th - while supplies last

Put a BIG Smile on their Faces... And some BIG Savings in your Pocket!

### STANLEY JR.® TOYS

284-1045  
CHILDREN'S WORKBENCH  
no tools included  
Reg ~~\$77.00~~ Sale \$69.30



284-1044  
TOPIECE TOOL SET  
Reg ~~\$60.00~~ Sale \$54.00



284-1043  
SPC. TOOL SET  
Reg ~~\$30.00~~ Sale \$27.00

284-1058  
FRONT LOADER KIT  
Reg ~~\$20.78~~ Sale \$18.70



284-1046  
CHILD'S WHEELBARROW  
Reg ~~\$45.00~~ Sale \$40.50

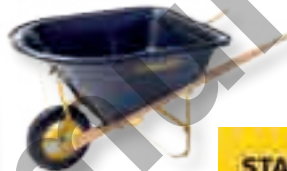

284-1049  
CHILD'S LEAF RAKE  
Reg ~~\$9.38~~ Sale \$8.44

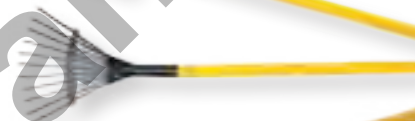

284-1048  
CHILD'S GARDEN HOE  
Reg ~~\$9.38~~ Sale \$8.44



284-1053  
PULL-BACK AIRPLANE KIT  
Reg ~~\$20.78~~ Sale \$18.70



284-1057  
RACE CAR KIT  
Reg ~~\$19.20~~ Sale \$17.28



284-1003  
SCOOP & STACK ICE CREAM CONE PLAYSET  
Reg ~~\$33.00~~ Sale \$29.70



284-1034  
GRILL & SERVE BBQ SET  
Reg ~~\$19.98~~ Sale \$17.98

284-1064  
CUTIE PIE BUTTERFLY KICKBALL  
Reg ~~\$13.20~~ Sale \$11.88

284-1069  
FOLD & GO BARN  
Reg ~~\$60.50~~ Sale \$45.38



284-1063  
FROGGY KICKBALL  
Reg ~~\$13.20~~ Sale \$11.88



Toll-Free 844-477-3268

## SPECIAL PURCHASE!\*

### PAY 25% OFF RETAIL!

\*While Supplies last!



**But...  
Let's not Forget  
the "BIG CHILDREN"  
on your List!**

**MELISSA AND DOUG® TOYS**



284-1075  
CUTIE PIE BUTTERFLY CAMP CHAIR  
Reg ~~\$32.20~~ Sale **\$28.98**



284-1076  
GIDDY BUGGY CAMP CHAIR  
Reg ~~\$32.20~~ Sale **\$28.98**



284-1000  
12 FURRY HORSES  
Reg ~~\$22.00~~ Sale **\$19.80**



284-1040  
TAKE ALONG FARM (17 PC SET)  
Reg ~~\$34.98~~ Sale **\$31.48**



284-1021  
CUTIE PIE BUTTERFLY NET  
Reg ~~\$10.80~~ Sale **\$9.72**

284-1031  
GIDDY BUGGY NET  
Reg ~~\$10.80~~ Sale **\$9.72**

284-1001  
10 FARM ANIMALS  
Reg ~~\$19.98~~ Sale **\$17.98**



284-1038  
BARNYARD RUG W/COW, PIG, HORSE,  
WOODEN TRACTOR, & TRAILER  
Reg ~~\$33.00~~ Sale **\$29.70**

over 4' wide!

284-1081  
BEAUTIFUL BUTTERFLY KITE 50"  
Reg ~~\$18.70~~ Sale **\$16.83**

284-1080  
SPECTRUM DIAMOND KITE 30"  
Reg ~~\$14.30~~ Sale **\$12.87**

284-1074  
RAINBOW STUNT KITE 33"  
Reg ~~\$16.50~~ Sale **\$14.85**

almost 3' tall!

284-1082  
DELUXE WOODEN STANDING ART EASEL  
Reg ~~\$80.25~~ Sale **\$72.23**



284-1059  
SWEET SHOP CHALK SET  
Reg ~~\$26.98~~ Sale **\$24.28**

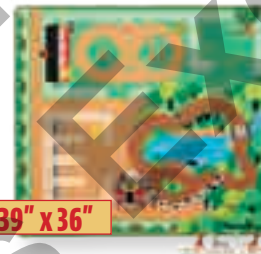

284-1037  
HORSE RUG W/4 PLAY HORSES & FENCE  
Reg ~~\$33.00~~ Sale **\$29.70**



284-1036  
TOWN ROAD RUG W/4 WOODEN CARS  
Reg ~~\$29.98~~ Sale **\$26.98**

284-1004  
FARM TRAIN  
Reg ~~\$19.98~~  
Sale **\$17.98**



204-1000  
TIGER COFFEE BUTLER,  
1.9 LITERS  
Reg ~~\$38.94~~  
Sale **\$35.05**



204-1021  
ALL AMERICAN PRESSURE COOKER, 30 QT,  
14 QT. CANS OR 19 PT. CANS  
Reg ~~\$387.29~~ Sale **\$348.56**

231-1037  
ULTIMATE EZ MILKER W/2.5 GAL.SS BUCKET KIT  
Reg ~~\$781.65~~ Sale **\$703.49**

204-1096  
18V 300W MAKITA INVERTER  
Reg ~~\$135~~ Sale **\$121.50**

204-1098  
18V 300W MIL/DEW INVERTER  
Reg ~~\$135~~ Sale **\$121.50**



**YUNEEK ROLL-AWAY NEST**

220-1000  
16" FOR 15 HENS  
Reg ~~\$143.00~~  
Sale **\$128.70**

220-1001  
24" FOR 30 HENS  
Reg ~~\$195.00~~  
Sale **\$175.50**

220-1002  
48" FOR 60 HENS  
Reg ~~\$246.00~~  
Sale **\$221.40**



**SPECIAL PURCHASE!\***  
**15% OFF RETAIL!** \*While Supplies last!



221-1004 DAISY PELLET BB GUN COMBO Reg ~~\$43.50~~ Sale **\$36.98**

221-1005 BBS 1500 COUNT Reg ~~\$9.98~~ Sale **\$8.48**

221-1006 PELLETS 250 COUNT .177 CALIBER Reg ~~\$12.74~~ Sale **\$10.83**

\*SHIPPING AND HANDLING FEE APPLIES

**THERE'S SO MUCH MORE IN  
OUR FREE CATALOG  
ASK FOR ONE!**

**Toll-Free 844-477-3268**  
**CALL OR FAX IN YOUR ORDER AND WE WILL SHIP IT TO YOU\***

12865-2 CR 30, MIDDLEBURY, IN 46540 PH: 574.642.4768 FX: 844-840-2470 MONDAY - FRIDAY 7:00AM - 3:00PM

**NEW  
ITEM!!**

**PHOCOS FREEZER/REFRIGERATOR**

**GREAT DEAL!**  
**CALL TODAY FOR PRICING & INFORMATION**  
**DEALER INQUIRIES WELCOME**



- \*Direct DC Battery operation
- \*Only pulls 5 amps while running on 12vdc
- \*2 year warranty
- \*Chest style design
- \*Xtra thick insulation, reduces compressor run time
- \*NEW FEATURE: boost switch for faster cooling
- \*Can be powered by 12v or 24v battery
- \*Can be used as a refrigerator or freezer, with adjustable thermostat



FR100B:  
 27"W x 33.5"H x 23.2"D  
 one basket

FR230B:  
 40.8"W x 33.5"H x 29.5"D  
 two baskets

FR350B:  
 58.1"W x 34.5"H x 29.5"D  
 three baskets

**BACHTOLD**

**Mower & Log Splitter Parts**

**ROOF**  
**Mower Parts**  
 Retail & Wholesale



**Reliable Power Inc.**  
 7174 N 1100 W, Bourbon, IN 46504  
 phone: 574-858-9250  
 fax: 574-858-2404

**EASY-JOB SPRAYER**

MSRP \$ 235.00 plus tax and shipping

We are now using the 20 Volt Dewalt / 18 Volt Milwaukee Combo



POWERED BY THE TOOL BATTERY OF YOUR CHOICE



RH Assembly LLC, Leon S Ebersol  
 550 Bellas Hollow Road, Danville, PA 17821  
 570-274-8292 We Ship UPS

**MYERS POULTRY**

*Quality Poultry Since 1988*

(814) 539-7026  
 myerspoultry.com

**FREE  
 Catalog**



Offering 150 + Breeds

- |                    |            |
|--------------------|------------|
| Cornish Broilers   | Turkeys    |
| Specialty Broilers | Ducks      |
| Layers Chicks      | Game Birds |
| Rare Breed Turkeys | Bantams    |
| Goslings           | Guineas    |

966 Ragers Hill Road  
 South Fork, PA 15956

**COFFEE TABLE LEGS**



**Mountain Elk**  
 Rustic Barn & Western Horse styles also available

Dimensions:  
 - 14.25" tall  
 - 13" wide at bottom  
 - 11.5" x 4.25" mount base with holes for screws

**\$75  
 per set**  
 Plus tax and shipping.

-- 29" high table legs also available--

**M&L Designs**

8005 Brenneman Rd. Shiloh, Ohio 44878  
**419-512-2589**

**New Holland c175 Track Skidsteer**

joystick control, 2 speed, open cab, auxiliary hydraulic. Low hours and in good condition. Bucket and forks included.

**\$25,000 o.b.o.**

I would consider trading for smaller stand behind.



CALL: 920-894-4995

**Weaver Edger  
 Customized Board Edgers**

**:Standard Features:**

- 3 5/2" overhead rolls
- Chain driven, conveyor feed
- 16" carbide tipped split blades
- Heavy Duty 2 1/4" main shaft
- Sliding drop deck table

**:No End to Options:**

- Adjustable speed feed
- Diesel Mounted on top
- Sawdust box
- Right or Left side guide a drive

Order yours with your Options

**Please write for free Literature**  
 Weaver Engine Shop  
 6610 140th Ave • Stanwood MI 49346

Back in the good old days,  
 people would stop Christmas shopping  
 when they ran out of money.



# NEW ITEM

**NATURE VIEW REELS**  
10 different reel sets available  
3 reels per set - **\$9.95** per set

# Farmerstown

## SHOE 'N' GIFT SHOP, LLC

Serving Amish and Mennonite communities throughout the United States

**STORES CALL FOR WHOLESALE PRICES**



**PACKAGE DEAL**  
all 10 reel sets and viewer  
**\$110.00**

**Farmerstown Shoe 'n' Gift Shop, LLC**  
2730 State Route 557, Baltic, Ohio 43804  
Phone: 330-897-1152 • Fax: 330-897-0021  
Toll Free: 855-897-1152

## LEID Diesel Service

2952 W Carson City Road, Sheridan, MI 48884  
Phone: 616-754-5871 Fax: (616) 754-8359

Wholesale and retail supplier for parts for stationary power units!

- New industrial grade radiators.
- New fan blades.
- New and rebuilt PTO clutches and clutch rebuild components.
- Controls and gauge panels available for most brands of mechanical and electronic engines.
- Engine rebuild kits for most major brand diesels.
- Bulk engine oil sales. Also low cost engine break-in-oil.

Custom stationary power units and generator sets — built to your specifications.  
Now an authorized distributor of King Oil! Call for pricing.  
We ship UPS and truck freight!

3 Locations to Serve You,  
267 Green Hill Road, Newville, PA 17241  
717-776-7725  
N12574 CTY HWY M, Thorp, WI 54771  
715-669-3799

## Farmway Welding

New Design

- Adjustable
- New Seat Design
- Swivel Option

call: 574.498.6147  
fax: 574.498.6148  
20097 Gumwood Rd. • Argos, IN 46501

Land Pride

Cub Cadet

Kubota

## ERB & HENRY EQUIP., INC.

22-26 Henry Avenue  
New Berlinville,  
Pennsylvania 19545  
(610) 367-2169  
Fax (610) 367-6715  
www.erbhenry.com  
email@erbhenry.com

## Diesel Engine Service

Detroit Diesel  
Engines • Parts • Service

717-733-3890

Series  
53, 71, 60  
92, 110, 149



## HOSS

2297 Yatesville Rd.  
Penn Yan, NY 14527

**CARBIDE INSERTS** (Box of 10)  
12 x12x1.5 (St. Bore) ..... \$14.50  
14 x14x2.0 Sq. .... \$15.00  
15 x15x2.5 Sq. .... \$22.50  
15 x15x2.5 (Byrd) ..... \$23.50  
15 x15x2.5 R150 ..... \$23.50

10+ boxes \$.50 disc. Also Other Sizes

- Spiral Cutterheads
- Specialty Saw Blades
- Moulder & Planer Steel
- Log Scanning Metal Detectors

Phone/Fax: 315-536-8705



## Forklift Certification for your employees

AT YOUR LOCATION OR OURS

Call Allen at **717-354-2583**

Hoover Repair LLC  
263 Kurtz Rd  
Ephrata PA 17522

Service & Repair: Skidloaders, Engines, Hydrostatics, Cylinders

Universal Quickattach...\$450 convert tractors or oldstyle hookups to universal	12v 16,000 BTU Coolant Heater \$247
Molded seat w/seatswitch hole & slides \$132	2 pc Cushion Seat w/seatswitch hole & slides \$98
Seat beltassy w/switch \$73	131693A1 7/8-13 spline coupler fits Case Skidloader \$70

Call or write for a brochure on aftermarket parts.  
#342 F4L913 Deutz, good runner, 77hp ..... \$4,500  
#325 3TNV64T Yanmar with radiator, 40hp ..... \$2,400  
#187 F3L912 Deutz, hydraulic power unit, 51hp ..... \$3,500  
#328 6B5.9 Cummins power unit, 116hp ..... \$3,500  
More engines in stock, call for listing.  
Aftermarket Kubota Engine Cylinder Heads  
**Kubota engine parts, Genuine & Aftermarket**  
**Aftermarket & Used Skidloader Parts**  
Radiators, Rims, Seats, Seatbelts, Bearings, Seals, Cylinder Seal Kits, Belts, Quickattach Parts, and more.  
**Rebuilt Skidloader: Cylinders, Hydros, Motors**  
New universal quickattaches for Case:  
1835, 1835B, 1835C, 1838, 1840 ..... \$1,200  
1845, 1845B, 1845C ..... \$1,200

## GD Equipment

414 Rowe Road Shippensburg, PA 17257  
Ph: 717-530-0170  
Fax: 717-530-7798  
VISA MasterCard Discover Amex  
UPS Daily

## STAINLESS DRINKER FOR HORSE BARN

24" L x 14" W x 12" D  
Drain & Overflow Ports  
15 Gallon Capacity

**\$489.00**



IN STOCK & FREE SHIPPING  
**717-678-3329**





**MOUNTAIN VIEW FARM PRODUCTS**

CORRUGATED PRODUCE BINS  
DORPER BREEDING STOCK

phone: 814.485.1237  
fax: 814.445.7191

**YOUR TOTAL FARM AND LIVESTOCK SUPPLY**

*Specializing in Cattle Handling Equipment*

406 RIGGS ROAD | FRIEDENS, PA 15541

Please no Wholesale Inquiries at this time.



**Portable All-In-One** FOR SAFE, EASY HANDLINE

STANDARD FEATURES

- Automatic Headgate
- Manual Headgate Available
- Bi-Fold Backgate
- Hinged Neck Access Doors
- Collapsible Tub
- Legal Road Width
- Adjustable Alley Width
- Adjustable Top Bar
- Easy Off Wheels
- 16' Diameter Tub
- Scale Ready

*You would not run most businesses without the proper equipment.  
Why are you not running your cattle enterprise in an efficient manner?*



**Deluxe Squeeze Chute**

- Automatic HD Headgate
- Bi-Fold Back Gate
- Hinged Neck Access Doors
- Palpation Cage Attached
- Parallel Squeeze

**Bale Misers, Hay & Grain Feeders**

- Feeds up to 2 - 5' x 5' Round bales, or up to 8' square bales
- 30 Feeding Spaces
- For Cattle
- Powder Coated



**CATTLE SCALES**  
In-Stock

FULL LINE OF **FENCING SUPPLIES**  
Permanent fence and Rotational Grazing

**Equipment Shipping**

We are working hard on getting low cost shipping options. Some communities get Free Delivery. Pick up discounts depending on order size. Delivery Trucks **Call for details.**

*A complete line of sheep and goat products.*



**We Ship Nationwide**

**Dealer Inquiries Welcome**

*Your Favorite Feeder Is Back*



**Holds 5lb. Dog Food**

**Plastic Chowtime Feeder**  
With Stainless Steel Chew Guard



33906 State Route 643  
Baltic, OH 43804

**Your Full Line Pet, Equine, & Dairy Health, Supplier**



FREE CATALOG  
330-897-6492

**Zena Mobile Welders!**



**Features:**

- 150A / 100% duty cycle
- High frequency DC current for better penetration
- Welding controls are built into the electrode holder
- "Charge/Boost" mode for charging 12 volt batteries & jumpstarting equipment
- Powered by an electric start Honda or Brilliant engine

**\$2,375.00 - Honda | \$2,200.00 - Brilliant**

Larger sizes and other options available including mig & tig, and kits for mounting in vehicles, tractors and line shafts.

**Let us custom build a welder to your specs!**



FORMERLY MADE BY MILLWOOD MACHINERY

**Corn Planters**

**NEW lever lift corn planter with rebuilt John Deere 7000 Max Emerge row units. Offering: 2 - 3 - 4 row**

NO HYDRAULICS

HORSE DRAWN AND 3 POINT HITCH OPTIONS AVAILABLE  
**2 AND 3 ROW CAN BE PULLED WITH 2 HORSES.**

**100 dollars off planter orders in December.**

**FREE BROCHURES**

**PINE RIDGE FARM SHOP**  
8904 Denton Run Place, Charlotte Hall, MD 20622



# Ooohh, so peaceful and quiet to do the laundry!

## Spinner

Spins most of the water out of your laundry to cut down on moisture in basement and faster drying time.



## 1/2" Flexible drive shafts

— choose the end you want —

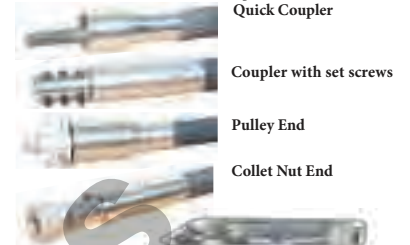

All stainless steel meat grinder — can be run with quick coupler or wash machine shaft.



2 wash machines can be run with one motor. You can also run 1 or 2 wash machines and a spinner with one motor.

Custom setups available.

- All stainless Steel ends on flex shafts
- Hardened spindles swedged on end of core for long lasting, quiet performance
- Call to order direct or for nearest dealer

## Lots of other tools available...

**CALL FOR A FREE CATALOG**



Bosch Mixer

Shafts  
3/16 and 1/4 flex shaft for small tools, choose whatever length you want

Flexible drive shafts in stock and ready to ship.



35cc Honda Power Unit with Centrifugal Clutch



Oster Blender Deluxe, all metal drive with glass jar.

Lots of power tools available!

We ship UPS or Mail



DEWALT - 4 1/2" Angle Grinder

Call or write for Free Catalog

**S.E. Drive Shafts**  
6100 South Carr Rd  
Apple Creek, Ohio 44606  
P (330) 815.2156

**Flexible**

Makes great Christmas gifts



DEWALT - Deluxe 1/2" Drill



Champion Juicer

New Model, Faster Clipping!



Small Animal Clipper



Graco Paint and Finish Sprayer



DEWALT - 5" Orbit Sander, Rear Outlet



DEWALT - Sawzall



DEWALT - Brad Nailer



DEWALT - Framing Nailer



DEWALT - Screw Shooter, Bottom Outlet



Oster Heavy Duty Sheep Shear



Cabela's Heavy Duty Meat Grinder



Rigid Multi Tool



Cleco Screw Shooter



Ingersoll Rand Dual Action Sander

## AIR-POWERED POCKET HOLE MACHINES



- Drills standard 15 pocket hole in approximately one second.
- A-2 hardened steel drill bushing/table insert.
- SIOUX 1 HP Air Drill
- Removeable control box for serviceability.

**Model SM-2500**

### MVM AIR ROUTERS (6 Models Available)

- Easy one handed operation
- Comfort Grip
- Precise depth control
- Dependable accuracy



**10" Inlet Blower Unit  
Model BL-2013**



**Check out the Neat-Stop System**

Available from MVM dealers or call us at MVM Tool Industries LLC  
Phone: 814-587-1994 FAX: 814-587-1812 [mvmtool@ibifax.com](mailto:mvmtool@ibifax.com)

## Now Introducing!! Lamp Oil 320™

**A HIGH QUALITY FUEL AT AN ECONOMICAL PRICE**

**An economical, and still a safe alternative for odorless mineral spirits.**  
For use as a substitute for odorless mineral spirits and kerosene in New Perfection oil stoves, kerosene lamps, heaters, refrigerators, etc.

**Mix or Match with:**

- White / Naphtha Gas
- Odorless Mineral Spirits
- 100% Mineral Spirits
  - Acetone
  - Hydrogen Peroxide 35%

- No loading dock needed
- Must be tractor trailer accessible
- Eight (8) drum minimum order
- **Excellent Quality**



**North American™  
LANTERN FUEL**

1233 Logan Run Road, Flemingsburg, KY 41041  
Call **606-845-0055**  
for a dealer near you.

## HEATED VESTS

**FEATURES:**

- Multi-Zone Heat Elements: 2x Chest and 1x Back
- 4 Selective Heat Settings
- Up to 10 Hours of Power Per Charge

**Color:** Black **Sizes:** SM, MD, LG, XL, 2XL, and 3XL  
**Includes:** (1) Battery (1) Micro USB Charging Cable

**\$35.00 FOR EXTRA BATTERY PACK**



**QUALITY ARCHERY**

19821 Hwy P, Verona, MO 65769  
417-498-2310

## SERVO MOTOR REPAIR

**Save money and downtime!** Rebuild and calibrate your servo motor to get your machine back into production.

- Allen Bradley
- Baldor
- Fanuc
- Indramat
- Kollmorgen
- Schneider
- Siemens
- Many others...



**PRECISION SERVO LLC**

4107 State Route 229, Marengo, OH 43334  
**877.866.0118**  
[service@precisionservo-usa.com](mailto:service@precisionservo-usa.com)

## TRANONT™ CHANGE LIFE

**Ask us how to get Wholesale pricing!**

2943 Edison Rd., Seymour, IA  
641-898-7186

*Do you have digestive problems? Lactose or gluten intolerant? Diabetic? Lyme's Disease*  
Try the Tranont Supplements it is 100% whole food plant based, 100% all natural and organic and probiotic enzymes available. Extremely effective. Your digestive system is 80% of your immune health. Fix your gut, fix your health!  
Call or write today! Free Shipping!

### RESTORE

- Promotes healthy immune system
- Aids in quick workout recovery and faster injury healing
- Helps improve protein digestion
- Antioxidant support

### VIBE

- Increased sense awareness
- Enhanced mood and energized feeling
- Heightened clarity and mental focus
- Improved concentration and memory
- Boosted circulation and blood flow

### BALANCE

- Daily nutrition to support general wellness
- Source of minerals, as amino acid chelates
- Antioxidant support (SOD)

### COLLAGEN

Glow is the first to combine the rejuvenating power of collagen peptides with a proprietary blend of 8 super antioxidant, high-ORAC fruits.

### LIFE

- Releases trapped vitamins & minerals from food
- Support healthy digestion, every time you eat
- Supports healthy bowel regularity

### CBD

Proprietary 100% natural whole flower fluid extraction process is superior to any other process available today as it preserves the entire medicinal profile of the plant, creating greater bio availability. 100% Plant. 0% Additive.

### TECHNO BOOST

- Nitric oxide is the "miracle molecule" that signals your blood vessels to increase blood and nutrient flow.
- Nitric oxide opens your blood vessels to increase nutrient flow through your body.
- TechNo Boost is a proprietary formula designed to increase nutrient and blood flow with 2-in-1 nitric oxide support.

### RADIANT

Slow down your cellular clock with vitamin E tocotrienols and geranylgeraniol which work together to help the body repair cells.  
Rejuvenate • Protect • Repair

### RELEAF

Ease the ache with Brizo Pure ReLeaf

*Testimony: I was Glucose intolerant but if I take 2 Life Enzymes before eating, I can eat anything. -A.M. Iowa*  
*Thanks to these great products my mood and alertness have improved, I sleep better and I don't feel like I need a nap after lunch each day.*  
*They are Amazing! -M.A. Oregon*

Call or write to Elmina Nisley at 2943 Edison Rd., Seymour, IA 52590 • 641-898-7186 for more information or to place an order.



# Phase Conversion for CNC's



**BOOSTER**

DIGITAL ROTARY CONVERTERS

- Designed with electronic controls in mind
- Compatible with varying loads



**MARTINS**  
ELECTRICAL SERVICE LLC

[boosters@martinselectrical.net](mailto:boosters@martinselectrical.net)

**570-668-4540**

**DYNA-CUT**

**Powered and Manual Shears**  
*to meet your metal cutting needs.*

**HRB-36**



- Replaceable tool steel blades with the profile of your choice
- Simply change the blade set to switch from straight to angle cut
- Cuts a 3/12 - 5/12 angle
- Heavy duty toggle clamp holds panel to ensure a quality cut

*Manufactured by:*

**Precision Metal Craft LLC**

10075 E 72nd ST, Reed City, MI 49677

**231-832-4222**

## Through the Eye of a Needle



Roger Hertzler. Jesus told us, "It is easier for a camel to go through the eye of a needle than for a rich man to enter the kingdom of God." And again, "Do not lay up for yourselves treasures on earth." Many Christians who take Jesus' commandments very seriously on nonresistance and divorce shrug off His Teachings on laying up treasures on earth. Hertzler challenges us to take Jesus' teachings on wealth to heart.  
112 pp. Paperback.

**FREE BOOK**

**Oh why oh why brethern we creatures of dust, do we seek for earths treasures that will rot and will rust?**

Our gold and plantations will burn by and by, when our Jesus returns from His home in the sky. I know of the pleasure, the pomp and the show, but i fear that such pride makes our Saviour's tears flow. Of the hungry, the naked, the cold, do we care, or those needing Bibles, oh why cant we share? When we stand before God on the great judgment day midst all the poor people what then wil He say? Come in faithful servant, Lazureths needs you took care, or go join the rich man in eternal despair? Are we not the brethern of that pleading rich man? Lets give and not join him, for today yet we can. Well never regret it while ages shall roll, in that Heavenly mansion, the home of the soul.

**Please Mail Your Request, To Free Book Offer**  
**PO Box 193, Richland PA 17087**

LEROY MARTIN

## **Idled taxis**

THAILAND- Hundreds of idled taxis are being utilized as “mini-gardens” in Thailand as the Covid-19 pandemic continues to dampen local travel within the country. The roofs of taxis are giving new meaning to the phrases “rooftops gardens” and “winter gardens.” Vegetable plots atop the roofs of fleets of taxis that have remained parked for months during the pandemic have caught the attention of the local media. Workers from a few taxi cooperatives reportedly assembled the gardens by using black plastic bags which they stretched across bamboo frames. Soil was then added, and a variety of vegetative crops were planted. Locals have said that the unusual scene represents that of an art installation, instead of a car park. The intent of the workers at the taxi cooperative was to raise awareness of the current plight of taxi drivers in Thailand. They and their operators had been badly hit by the extended Coronavirus lockdowns. Earlier this year, several thousand taxis have been sitting idle at numerous locations throughout Thailand’s largest, most densely populated cities. Out of work, many of the drivers cannot afford to continue making the payments for their cars and have chosen to abandon the vehicles.

## **Monkey business**

INDONESIA- With the lack of tourist handouts, hungry monkeys have been raiding homes within the region of Sangeh. The region is typically rife with tourists who are all too eager to feed the swarms of monkeys that are native to the region. Due to lockdowns during the spring, summer and autumn, tourists have largely been unable to visit Indonesia this year. Deprived of their favorite food source—bananas—scores of monkeys have resorted to mischief, breaking into homes and raiding what food supplies they could find. Many locals who worried that the monkeys may wield an all-out assault if their hunger isn’t appeased, began taking large quantities of food to the local monkey forest in hopes of curbing their behavior within the villages. “We are afraid the monkeys will turn wild and vicious if we do not feed them,” a local man said. Approximately six hundred hungry monkeys reside in a forest within proximity of a village where the man resides.

## **Mistaken marathon**

ILLINOIS- An Illinois man won the Quad Cities Marathon in a rather unexpected manner recently. When two Kenyan runners who had outpaced the Illinois native by an impressive length became unqualified after they took a route that was not listed, the man—who had been in third place—won the foot race. Race directors said the confusion regarding the route should never have occurred, because a meeting had taken place the previous day, where all the runners had become very acquainted with the route they were to take. “The signage was there and well placed,” the directors said. “This incident should have never happened.” Even so, the Illinois runner appeared happy with the results of the race.

## **Shoe shows**

AUSTRIA- In another foot race, a case of wearing the wrong shoes resulted in the winner being disqualified and stripped of his medal. Ethiopia’s Derara Hurisa crossed the finish line first by three seconds but was later informed that he lost the race due to his shoe choice. The soles of his shoes had measured 0.4 inches thicker than the allowed maximum. Organizers of the event said that the runner had registered another shoe that met qualification standards, but then switched the shoes prior to running in the race.

## **Subway silence**

NEW YORK CITY- Earlier this year, the MTA pushed for an additional round of emergency federal aid to fund its subways, buses, and commuter trains after it experienced a dearth of workers. The severe shortage of personnel who were willing to work had served a harsh blow to the city’s subway system. As a result, the city was offering retired train operators \$35,000.00 for ninety days of work. Desperate transit officials were reaching out to the retired train operators in hopes of convincing them to return to work—if only for ninety days. The New York MTA typically employs more than 66,000 people, but during 2020, more than 5,000 workers consistently failed to report to work. In August, more than ten percent of rush hour trains were canceled, resulting in the worst performance since 2015. In January 2019, the MTA employed nearly 3,600 train operators.



## Amazon anxiety

SOUTH AFRICA- The retail giant Amazon has recently raised a stir in Cape Town. The politically charged controversy which surrounds the retail behemoth's plans of building a massive warehouse and distribution center within the region, has resulted in an uproar amongst locals. Indigenous groups say the planned project will disrupt and damage indigenous land, which they consider sacred. The land which Amazon wishes to build on must remain protected and named as a World Heritage Site, according to those opposed to the building project. The site has long been an exclusive space for a members-only golf club and sits in the shadow of Cape Town's iconic Table Mountain.

## Consistent containers

ASIA- Nearly ninety percent of the world's goods are transported by sea. Whether you are eating a banana, enjoying your morning coffee, or walking in the shoes you are wearing, it is very likely that these items arrived within the country via shipping containers. It is estimated that virtually every major home and office appliance—or their parts—were once loaded onto a large container and shipped to countries around the world. Nearly all imported fruits are packed in large steel containers and shipped thousands of miles to their destination. More than \$14 trillion of the world's goods (shipped annually) have at some point in time been inside shipping containers or otherwise been transported on a ship. The standard shipping containers that most of us take for granted provide us with the opportunity of consuming goods and products from all over the world. Without these containers—or adequate amounts of them—shipping supply chains become severely disrupted. A recent shortage of these containers has increased prices for all sorts of goods. A notable piece of interest: in 1956, the cost of manually unloading a ship cost \$5.86 per ton. The invention of the standardized shipping container helped lower the cost significantly. It now costs only sixteen cents a ton to unload a ship.

## Hot home

MASSACHUSETTS- The housing market is so strong in this state that a burned house has been put on the market with an asking price of nearly \$400,000. The home has been severely damaged by smoke and fire yet has still been placed on the market in a region where family homes currently have been selling between \$535,000. and \$552,000. The online listing for the charred house indicates it is a three bedroom, 1,857-square-foot home. "Buyer to do due diligence. House being sold as is. In need of total renovation" read part of the description.

## Circling houses

BOSNIA- A man built a rotating house for his wife after she consistently complained about the unchanging and drab view from her windows. Looking to provide his wife with a more satisfactory scene, the man began focusing on how he could

build a house that would rotate slowly, changing the view every few hours or every twenty-two seconds, whichever the wife prefers. At its slowest speed, the house can rotate completely within a twenty-four cycle. The man is seventy-two years old and had this to say about his unusual invention: "After the children took over the family business, I finally had enough time to task myself with granting my wife her wish." Even at his old age, he diligently remodeled the house and transformed his home from a stationary one to a rotating one. It reportedly took six years to build the house, which rotates on a twenty-three-foot axis beneath the floor. Due to its rotational capabilities, some folks in Bosnia say that the house stands a better chance at withstanding an earthquake.

## Honest teen

LIBERIA- A teenager recently found and returned fifty-thousand dollars to its rightful owner. The teenager is a motorcycle taxi driver and found a bag containing the large sum of cash lying beside the roadway. A businesswoman lost it and pleaded on the radio, asking anyone who found it to return it to her. After the teen heard these pleas, he decided that he will return the bag to the distraught lady. The teen received praise from the Liberian Anti-Corruption Commission and was invited to meet with the country's president the following day. His friends, however, had differing thoughts on the matter. According to them, the teen will "never get rich because he acted stupid to return the money." The friends also won't help him anymore and have distanced themselves from him.

## Rising prices

Inflation has increased prices for food, gas, used cars, and nearly everything else. In September 2021, food prices had risen nearly five percent from the previous September. Price increases for food and energy are significant and are affecting most regions of the world. According to the Labor Department, meat saw the biggest rise in prices during late 2021 than any other food in the United States. Poultry, fish, and eggs had increased in prices by slightly more than ten percent. Beef, however, had risen nearly eighteen percent from the same time the previous year.

---

Researched, written, and edited by *Leroy Martin* for the exclusive use of the *Plain Communities Business Exchange, LLC*.

**Each of us is an innkeeper who decides  
if there is room for Jesus.**

# Considering A Business In **STANDING SEAM ROOFING?**



**AVAILABLE WITH A  
100% MECHANICAL SETUP  
POWERED BY A HONDA ENGINE**

**COMPLETE UNITS AVAILABLE**

## **PORTABLE ROLLFORMING ROOFING & GUTTER MACHINERY**

### **SALES • SERVICE • SUPPORT**

Masterpiece Metal Roofing is NTM approved to provide training, support, and customer service. As an owner and operator of NTM products we have the knowledge and expertise to assist you with any questions and problems you may encounter.

**Sales:** Orv Schlabach • **Tech Support:** Lonnie Troyer  
**CALL TODAY • (260) 463-4010**



**New Tech Machinery**

A **MAZZELLA** COMPANY



Office (260) 463-4010 • Fax (260) 463-4011  
2510 S 250 W • LaGrange, IN 46761



## NEW! Easy Power Lamp Adapters

Convert your electric light to battery power! Just change the bulb & plug it in!



Includes Battery Shut Off and Low-Voltage Blinker, so your battery will last and last!

(Low Voltage Output Only)



# ORDER NOW FOR CHRISTMAS



Mix & Match  
Light Styles & Colors

Easy to Install

Use with the Battery of your Choice

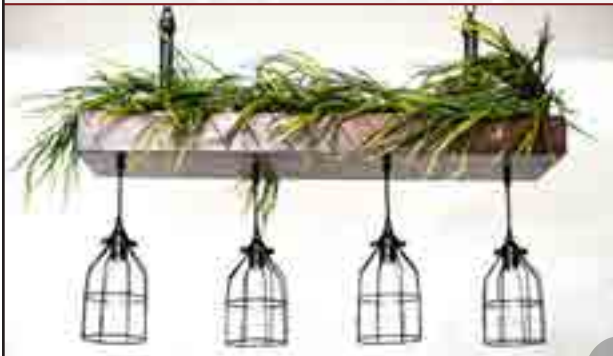

## Homestead lights



To Order, or for Dealer Inquiries:

LaVern Kauffman  
(260) 562-2800

## BIG STEAM ENGINE BOILER Horizontal Boiler Roughly 100 HP

For Sale

Will Send Pictures To Serious buyers  
Write For Pricing And Phone Number.

Price is Negotiable.

Harvey Borntreger

N 4145 Catlin Avenue Granton WI 54436.

## TAKEUCHI TRACK HOE

Model TB53FR, Year-2004,  
Full Cab with heat,  
Good Tracks, 38-hp,  
Yanmar engine,  
30-inch bucket,  
serial # 15810862,  
boom side shift,  
works great.

Price  
**\$26,900.00**



## MARTIN EQUIPMENT & SALES

1375 Lower Clover Creek Rd, Williamsburg PA 16693

814-832-2306

melvinjomartin@gmail.com

# Coffy Brake quiz

December 2021



### How many light bulbs are illuminated?

There are 100 light bulbs lined up in a row on the ceiling of a long hallway. Each bulb has its own switch and is currently switched off. The hallway has an entry door on one end and an exit door at the other end. There are 100 people lined up outside the entry door. Each bulb is numbered consecutively from 1 to 100. So is each person. Person No. 1 enters the hallway, switches on every bulb, and exits. Person No. 2 enters and flips the switch for every second bulb (turning off bulbs 2, 4, 6, 8, ...). Person No. 3 enters and flips the switch for every third bulb (changing the state on bulbs 3, 6, 9, 12...). This continues until all 100 people have passed through the hallway. What is the final state of bulb No. 49? And how many of the light bulbs are illuminated after the 100th person has passed through the room?

How many light bulbs are illuminated? What is the final state of bulb No. 49?

Mail your answer to: PCBE Coffy Brake • P.O. Box 520, Millersburg, PA 17061 | Your answer must be received by is January 6, 2022

To submit Coffy Brake Riddles, Send To: PCBE / Coffy Brake Riddles • P.O. Box 520, Millersburg, PA 17061 | (All riddles sent to us by our readers and printed in PCBE will receive a \$25 Gift Certificate from Sunrise Naturals).

The randomly selected winner will receive  
a \$50 Gift Certificate from Sunrise Naturals



PO Box 127, Millersburg, PA 17061  
(877) 278-1090



# East Coast Drywall Tools

INCREASING SPEED! INCREASES PROFIT



**SALES, SERVICE AND REPAIR**

## FINISH DRYWALL FASTER!

Need a repair? Questions-Call us.

Visit our showroom.

WE SHIP



We accept credit cards.



1122 Siddonsburg Road, Mechanicsburg, PA 17055

(717)-766-0608 • 1-800-223-4854

Website: [www.eastcoastdrywall.com](http://www.eastcoastdrywall.com)

Email: [info@eastcoastdrywall.com](mailto:info@eastcoastdrywall.com)



Laurel's Boutique offers a new collection of dress designs not available from wholesalers. Printed on polycotton blends and some new types of polyester, our goal is to produce lovely fabric that reflects conservative taste. We fill mail orders daily, and we welcome you to call ahead for a visit to our store as well. For \$10 per year, we will send physical samples to your mailbox each time a new shipment comes in. If you are interested in receiving email updates, or would like to see a flyer that includes our current inventory, please contact us. We look forward to serving you!

*Laurel's Boutique*

1146 Vista Lane  
Eitzelstown, PA 17022

(717) 579-4117

[laurelsboutique@cox.net](mailto:laurelsboutique@cox.net)



## 2 Introductory Offers

(Not valid for renewals)

### 12 Nature Friend magazines

Helping Families Explore Creation Since 1983

Mention coupon code: **PCBE-SNAO**

Choose one of these two offers:

\$40 Now only \$35

or

\$45, + **North American Owls book** (\$75 package value.)

USA offers. Not valid for foreign.  
Please subscribe within 15 days.

Address 1

Name

Address

City, State, Zip

Address 2

Name

Address

City, State, Zip

Gift Giver Address

Name

Address

City, State, Zip

Tel. ( ) - - Check #

CC exp. / / 3-digit code

Visa or Mastercard

**Nature Friend Subscriptions**

4253-PCBE Woodcock Lane

Dayton, VA 22821

(540) 867-0764 or (877) 434-0765

## DO YOU BELIEVE WOMEN'S HEALTH MATTERS?

Try the Reign Premium  
Sanitary Napkin Safe - Comfortable



Reign sanitary  
Napkins are  
**\$6.00** a pack

Free Shipping on bulk orders

Call or write for free information and samples.

To Order Call: 844.789.1033

Use one of the following distributor ID's

Mary Troyer 10601 S. Jefferson Rd. Shreve, OH 44676 330-473-2311 ID# 109196	Sarah Troyer 7712 Hoy Road Fredericksburg OH 44627 330-439-8387 ID# 132017
---	--

Benefits of Graphine in Santary Napkins

- Relieves Stress
- Controls Bacteria
- Enhances Metabolism
- Improves Hormone Secretion
- Strengthens Immune System
- Helps with Dysmenorrhea



### NEW Vitamin Sprays

**\$15.00**  
each

Oral Absorption  
is 9x's greater  
than pills.

FOUR OPTIONS

Reign Women's Multi Reign  
Vitamin C & Zinc  
Reign Vitamin D  
Reign Lean/Keto

**QUALITY ESSENTIAL OILS**  
NO MULTI LEVEL MARKETING  
AFFORDABLE PRICES



Send \$5.00 for catalog,  
\$5.00 will be returned with your 1st order

Deodorants, shampoos, lotions, toothpaste,  
hairspray, all natural perfume.

**Rachel Weaver**  
11019 Township Road 516 Shreve, OH 44676  
330-600-8289



## DID YOU KNOW??

It is now easier than ever to build your **immune system** and **detox** in you own home.

Thanks to the **Relax Far Infrared Sauna!**

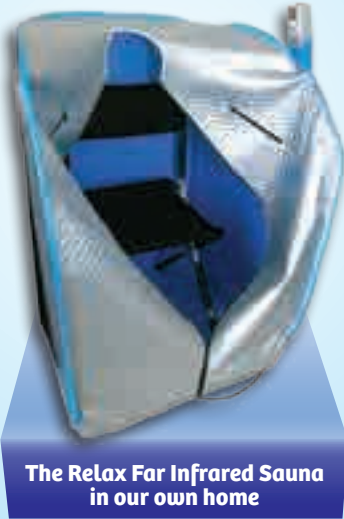

The **Relax Far Infrared Sauna** is Portable, easy to set up (takes about 5 minutes), and fits into bedrooms or bathrooms.

The therapeutic heat in the Relax Far Infrared Sauna causes you to sweat which releases toxins. "You say you can't Sweat"? Most people can after using the Relax Sauna. We have proven this in a clinical Setting!

The Relax Far Infrared Sauna in our own home

Call to Order a Relax Far Infrared Sauna for your own home!

**WE SHIP  
NATIONWIDE.**

Stevie Petersheim  
**Crystal Spring Nutrition**  
175 Broad Street, Rebersburg PA 16872  
Phone # 814-349-5171 ext.0

# COLD FORGING, METAL FORMING, STAMPING, ETC.



- Production Press Work
- Stamping and Bending Dies
- Custom Threading

Stainless Steel or Steel  
3/8 & 7/16  
T-Rod Links

**Wholesale Inquiries  
WELCOME**

**Lindenholz  
Blacksmith Shop**

Manufacturers of Axle Clips & Clip Bars

202 Parkview Heights Road  
Ephrata, PA 17522

Andrew Stauffer

**Stauffer Diesel Inc.**  
Incorporated 1963

**SPECIAL ENGINE SALE!**  
**S-70 POWER UNITS \$7,995**



- **Deutz Model D2011L04o**
- **62 Horsepower**
- **Low profile package**
- **Naturally Asp**
- **Oil-cooled**
- **Dealer discount available**

These engines are all new with no service hours  
T4i: meets current EPA requirements  
SDI 1yr/2,000hr warranty applies

34 Stauffer Lane • Ephrata PA 17522  
Engine Sales: 717-721-5112 • Parts: 717-721-5100  
mstauffer@staufferdiesel.com  
www.staufferdiesel.com

S181.19

# TRIM BRAKE

FOR PLAIN PEOPLE

- 1 HYDRAULIC POWERED
- 2 NON CNC CONTROLS
- 3 SINGLE OPERATOR  
UP YOUR PRODUCTIONS!
- 4 POWERED APRONS  
SAVE YOUR BACK!
- 5 ACCURATE BACK GAUGE  
NO MARKING!
- 6 SIMPLE SETUP WITH MAGNETS
- 7 10" 8" AND 12" 6" AVAILABLE
- 8 RETROFIT OPTIONS - CALL FOR DETAILS!



**CALL NOW  
FOR A FREE  
BROCHURE**

**STOLLMETALWORKS**

SOLOMON STOLL - JOEL LESHER  
6600 BACK LANE WAYNSBORO, PA 17268  
PHONE: 717-387-5572



# What..... you are still removing the nails by hand!!

Introducing

## THE BUCKEYE DEMAILER

The Ultimate Machine for the Reclaimed Lumber Industry  
in the removal of Hardware in Reclaimed Wood

Call for a  
FREE  
Brochure



Quality  
Durability  
Satisfaction

Numbers don't lie.....

6 People By Hand	1 Person The Buckeye Demailer
4,000 lbs 11,000 ft <sup>2</sup> per hr 110,000 100,000 100,000	1 Person 230,000 per hr 100,000 100,000 100,000
Yearly Cost: \$210,000	Yearly Cost: \$37,250

Profit Gain  
**\$173,050.00**

\* Using a set of custom designed & hardened alloy steel jaws to pull the nails, this machine eliminates the time consuming process of removing the nails that are broken off flush or even thro through the surface of the wood. The jaws can go up to 1-500' deep to extract even the toughest nails.

\* Riding on a manually positioned carriage that travels over a 14" x 114" horizontal area, the jaws are pushed into the reclaimed lumber by a vertical high pressure 118" stroke hydraulic cylinder. The control buttons are all conveniently placed on the handle for easiest operation. The lumber is held in place by 3 clamps that are operated by a foot pedal.

\* The Buckeye Demailer operates on electric & air supply. Air, controls, and hydraulic power options are also available.

\* This machine is proven to extract 7 nails per minute average on a daily basis. Using statistics from real world usage, this machine being operated by 1 person, will out perform 6 people removing nails by hand.

Here what Customers are saying:

We are running two machines. They are awesome. They save a lot of time and energy, we would not want to do without them. We have girls operating them.

The Demailer machine works great and the company has very good customer service. Overall it's a great machine.

For a Brochure or Information call:

Buckeye Welding & Mfg. LLC  
2507 TR 110, Millersburg, OH 44654  
Ph. 330.674.2585 Fax 330.674.2567

For a live Demo call:

Yoder Dry Kiln  
29881 State Route 643, Presto OH, 43824  
Ph. 740.623.2006 Fax 877.249.6260

**GRABER**

Heating Supply LLC  
**812-787-0760**  
"Specializing in radiant heat"

- Oil Creek Pex
- Pex Fittings
- Manifolds
- Navien NCB, NFB Boilers
- Navien NPE Tankless Heaters
- Crete Heat Floor Panels
- Grundfos Pumps



COMPETITIVE PRICING ON CUSTOM, PRE-ASSEMBLED  
BOILER SYSTEMS! READY TO INSTALL.  
SHIPPING AVAILABLE

2318 N 800 E  
Montgomery, IN 47558

graberheating@hotmail.com



Formerly "Martin's Farm Supply" Now...

# Martin's Supply LLC

Custom  
Structural Steel  
Fabrication - Bridges,  
Overhead Cranes  
Structure Stairs,  
Platforms, Railings



#5561-"New Bar  
Joist never erected!!"  
Manufacturer fabricated the wrong length!  
• 8pc. 40" H. x 57' L - joist  
• 12pc. 40" H. x 54' L - joist  
• 1pc. 66" H. x 54' L -(Girder)

Wide Flange Beams

H - Beams

S - Beams

Angle, Channel, Tube, Plate, Sheet,  
Flat Bar Round & Square Bar

(1/2" through 6" sch. 40 Black &  
Galvanized)

Large Inventory of new, surplus and  
used beams up to 60' long



#5562- is (4) -5 ton adjustable spreader  
bars (2) -10' Spread, (2) -7' spread



#5564- is (1) -2 ton  
spreader bar -4'6" spread.



5 Ton, P&H, Span 52' 5", 18' Lift,  
Class D, Radio, VFD Bridge



#279-(2 available) 5 ton Konecranes  
cable hoist (power trolley) "like new"



#281- 2 ton CXT cable hoist  
(power trolley) "like new"



#282- 2 ton Konecranes (chain hoist)  
"good condition"

Konecranes 5 Ton Electric Hoist  
CXT40410050P35FBL0F With Trolley 460V #70HK

Other Used Hoists available.

Appears like it was never used



Contact us at:  
4491 Buchanan Trail West,  
Greencastle, PA 17225  
717-597-4283

Delivery available!

# VACUUM the air in your shop!



**REMOVES:**

- DIESEL SMOKE
- WELDING SMOKE
- OIL MIST
- GRINDING DUST
- WOOD DUST

OPTIONAL REMOTE CONTROL AVAILABLE

**NO EXHAUSTING**

You have seen this powerful 2500 CFM clean air machine sell for \$2,800 to \$3,300 each...

Now **Air-Vac Systems Inc.** offers this same powerful 2500 CFM industrial air cleaner for only **\$1,999!**

Change main filter every one or two years (\$81-\$86) and 4" pre-filter every 2 months (\$13)

Each unit will clean the air in a shop up to 2000 sq. ft. (Larger shops simply add more units)

**— CAN BE POWERED WITH AIR OR HYDRAULICS —**

Contact us at  
**800-234-2473** or Rob 319-231-4711  
**www.Air-VacSystems.com**

# RT WOOD PRODUCTS

Family owned and operated since 1994  
 Raymond & Ada Troyer and Family

## QUALITY CEDAR CHEST KITS

**READY TO ASSEMBLE**

A good way to start a business at home without a big investment. Chests also available assembled and finished.

**WE DO CUSTOM GLUE UPS**

Panels up to 42" x 144"  
 Squares precision end trimmed.  
 Sanded on four sides.

**20 YEARS EXPERIENCE.**

Trucking available to most areas.

For more information write to:

**RT Wood Products**  
 13070 Nisley Road, Fredericksburg, OH 44627

# CollagenB<sup>3</sup>™

With MCT and Hyaluronic Acid



CollagenB3 is a unique, synergistic blend of Collagen Protein, MCT Oil, Hyaluronic Acid, Chaga, with a Mineral Complex, plus Amino Acids, Cordyceps, Magnesium, and Ginseng to help you look, think, and feel amazing.\* This comprehensive collagen product is perfect for those looking to support healthy hair, skin, nails, musculoskeletal function, and to provide brain fuel for energy and focus.

Collagen is the body's most abundant, fibrous protein that helps give structure and strength to hair, skin, nails, bones, ligaments, and tendons. Collagen is derived from the Greek word for glue as it holds everything in the body together. Because of collagen, we're able to move and flex.

Your skin is made up of 70% collagen. When your body isn't producing enough collagen inside, it starts to show on the outside as fine lines and wrinkles. The skin becomes less flexible, hydrated, plump, and elastic. As we age and put more stress on our bodies, collagen production begins to decline. The good news is that by adding collagen protein to a balanced diet, you can rebuild this essential!

Collagen protein and whey protein have somewhat different roles in the body. While both are proteins with unique amino acid profiles, collagen is a structural protein, while whey is more often associated with building muscle. That's why you should still supplement your diet with SiselLEAN™. Plus, Sisel's Collagen B3 is not a meal replacement.

**sisel fitness**

*I sprained my wrist and after multiple re-occurring injuries and living with occasional pain for 1.5 years, all the pain cleared after taking Collagen B3 for about 2 weeks.*  
 Jerry Fisher - Allenwood PA

**Jerry and Kathryn Fisher • 570-217-3618**

# PUPPY Saver

- Lightweight Poly Box
- Stainless Steel Edging
- Electric Heat
- Sloped Floor

Prices starting at **\$575.00**

Rent for \$20 a week

Dealer inquiries welcome

Contact:  
 Kenton Zimmerman  
 610-286-1795  
 Call for nearest dealer

**OPTIONS:**

- Digital Thermostat
- Stainless Steel Safety Rail
- Heavy Duty Whelping Mat
- Available In Two Sizes 30" x 38" or 38" x 46"





# Small Business ACCOUNTANTS



## Financial Intelligence for your Small Business

- Accounting & Bookkeeping Services
- Business & Individual Taxes
- Payroll Check Writing
- Consulting and Profit Analysis
- Organized Recordkeeping System Provided
- Grow Your Business, Make More Money and Achieve Better Cash Flow
- Tax Planning - No Surprises at Year End



"Finally, an affordable Accounting solution... Now, I can focus on my business!"

### The Ellis Group, LLC



900 Century Drive  
Mechanicsburg, PA 17055  
Email: info@ellisgroupservices.com  
Website: www.ellisgroupservices.com  
**717-796-7010**

# Nickel Mine Welding

## Push Cultivator \$130

- Pull the pin & move the cylinder 1/4 turn for a row marker

Rubber tires available

With hard rubber \$140.00

Approximate shipping cost \$80.00



Optional Row Marker \$15

## Pony Cultivator \$145

- Includes single tree adjustable width

- Does not include row marker

With hard rubber \$155.00

Approximate shipping cost \$80.00

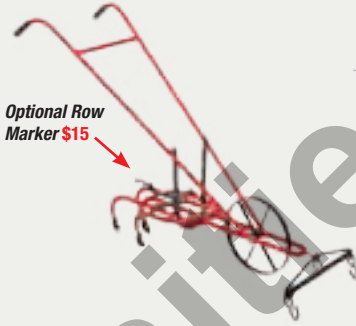

## Shovel Harrow \$265

- Includes single tree

adjustable width

Call for shipping rates

Adjustable wheel height



891 Georgetown Rd., Paradise, PA 17562

**Phone: 717-786-7363**

MADE IN THE USA

## SUNNYBURN BLAST GATE SERIES

We were inspired to design a totally customizable blast gate. Designed with multiple possibilities – modify and add different configurations even during use to achieve maximum productivity.

**SQUALL**

**CYCLONE**

**VORTEX**

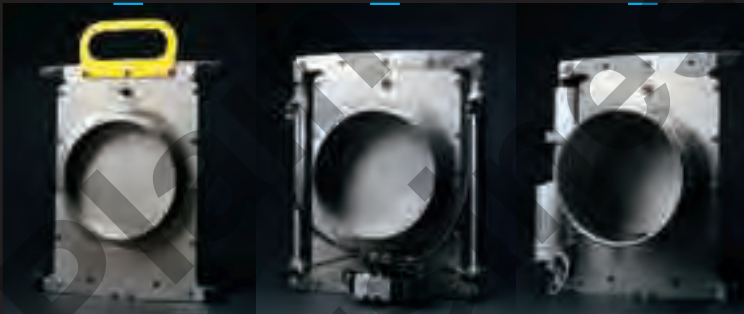

### MANUALLY OPERATED

The Squall is our manual blast gate design. This is the foundation for all our blast gates. Constructed of heavy duty stainless steel, it is a perfect starting point for your custom needs.

### PNEUMATICALLY OPERATED

The Cyclone has the same basic features as the Squall. We added air cylinders for rapid, smooth open-close operation. The cylinder speed is adjustable but the stroke length is not.

### ELECTRICALLY OPERATED

The Vortex uses the same proven design as the Squall with an added electrical actuator that has a wide range of possibilities, from simple open-and-close to fully automatic air flow modulation.

PROUD MAKERS OF THE SUNNYBURN BLAST GATES



CALL FOR MORE DETAILS AND PRICING

10 S NEW HOLLAND RD SUITE 1 GORDONVILLE, PA 17529  
OFFICE 717.929.0472 ONLINE IdealManufacturingLLC.com

*Foliar Fertilizing a crop is a guarantee that 100% of fertilizer is going to be absorbed by the crop.*

*So prepare to "FEAST" your plot this spring and summer.*



*Foliar Feed "FEAST" and watch the plot, and antlers grow!*

**To get started call:  
989-261-3099**

*Orders over \$500 qualify for free shipping*

# Advanced 3 DIMENSIONS

EASY • FAST • ACCURATE



## New Leica DISTO S910 P2P Kit

Stop climbing on the roof to take measurements.

Take measurements from the ground with the most accurate & trusted laser measuring tools!

## LASER MEASUREMENT & LAYOUT TOOLS

New

MIDWEST  
**Tool Expo**  
& Auction  
January 28 & 29, 2022  
VISIT OUR  
BOOTH  
Shipshewana, IN



Available in Red or Green

## Leica Lino L6R or L6G

A new take on multi-line layout  
Green laser is 4 times brighter than Red!

For more information call & ask for Noah or Adam:

**607.437.0165 | 800.774.6102**

or mail us at:

AdvancedDimension.com

2259 State Highway 7

Unadilla, NY 13849

Adam@AdvancedDimensions.com | Noah.a@AdvancedDimensions.com

Merry  
Christmas

from the staff at

**PCBE**



# TURBOSAWMILLS ARE IN STOCK AND READY TO SHIP

## MANUAL WARRIOR SWING-BLADE SAWMILL



Starting at \$12,500



Starting at \$11,000

## WARRIOR SLABBER SAWMILL

**AUTOMATED WARRIOR SWING-BLADE MILLS WILL BE IN STOCK FEBRUARY 2022**



TurboSawmill is the most innovative portable sawmill globally and uses swing-blade technology, a unique open side frame, and patented automation. TurboSawmill will produce accurate, dimensional lumber with every cut. Automated or manual models are arriving. Give us a call to know the available models.

# CALL JAY: 318-266-8091

Smith Sawmill Service P.O. Box 510, Garrison, TX 75946

# THE WATER SOLUTION™

An Extra Ordinary Structuring Unit

>>> Upgraded More Powerful...



Requires NO Electricity

...Stainless Steel Unit <<<

## Makes City & Well Water Healthier for You Than any Filter Will

### The WATER SOLUTION Does so Much More Than Just Restructuring Your Water

It micro-clusters/re-structures water (makes water very hydrating for your body), neutralizes toxins, eliminates pathogenic bacteria, clears toxic frequencies in water, & energizes water with powerful healing frequencies.

### What people are saying about THE WATER SOLUTION:

- ▶ Better Energy & Mental Performance
- ▶ Better Overall Health & Body pH
- ▶ Better Digestion, Kidney, & Bowel Function
- ▶ Joint Pains Go Away
- ▶ Water Tastes Better and Feels Softer
- ▶ Drink More Water Without Feeling Bloating
- ▶ Plants Do Much Better
- ▶ Better Milk Production in Dairy Cows & Goats
- ▶ Better Egg Production in Chickens & Ducks
- ▶ Hard Mineral Deposits Dissolve and Are Prevented in Water Heaters & Boilers
- ▶ Detergents Suds and Clean Better

### ONE YEAR MONEY-BACK SATISFACTION GUARANTEE & LIFETIME WARRANTY

Stainless Steel Unit: For 1/2", 3/4", & 1" Water Lines \$1595.00 & Free Shipping  
 Stainless Steel Commercial Unit for 1 1/4", 1 1/2", & 2" Waterlines: \$2595.00 & Free Shipping

Glen Lehman

22423 NW County Road 1493  
 Alachua, Florida 32615

Phone: 260-350-1054

Email: [watersolutionunit@gmail.com](mailto:watersolutionunit@gmail.com)

## COMPLETE MOTOR AND PUMP SERVICE

We offer complete services for motors and pumps, including repair, rewinding, and other services. We also sell motors, pumps, drives, and parts from top quality brands including Leeson, Fuji, Goulds, Barnes, and more.

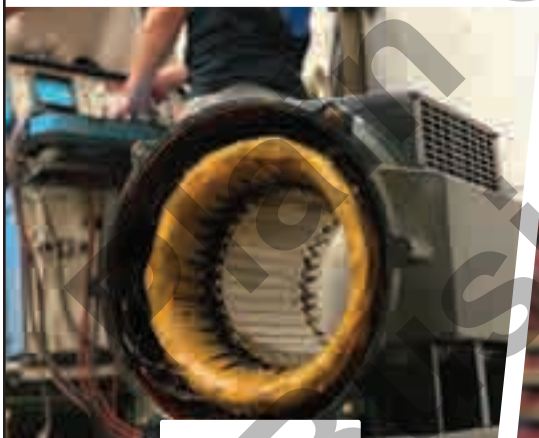

REPAIR



REWINDING



FIELD SERVICES



Ask about our planned maintenance and specialty services.

**717-366-8435**  
[slaymakergroup.com](http://slaymakergroup.com)



# GREAT BUSINESS OPPORTUNITY

## DURALAST COATINGS

Phone # 317-345-7283

*LIMITED AREAS, GET IT WHILE IT IS AVAILABLE*

Call to schedule with DURALAST COATINGS for one day installation training course. We have a complete package of everything you need to be a successful coating installer. Training session is **January 21st, 2022**. Classes are limited. Call to reserve your spot today! Phone: 317-345-7283

### LOOKING FOR INSTALLERS

Start your own  
**BUSINESS!**

We have a complete package of everything you need to be a successful coating installer.

Ask about our  
**ONE DAY  
Floor Coating System!**

CHIP AND GLAZE FLOORS  
UNLIMITED COLOR OPTIONS  
CONCRETE OR WOOD



Great for: dog kennels, pole barns,  
basements, garages, sun rooms, offices,  
patios and much more. . .

5 times stronger than epoxy  
Lifetime warranty  
Will not chip or peel. . . Easy to clean



# RADIANT FLOOR HEAT

*The most efficient way to heat your home or business!*

**NOW AVAILABLE!**



**CUSTOM MADE - PRE-ASSEMBLED**  
Ready to hook up to your system  
Available in Pex or Copper



**TANKLESS HEATERS**  
Up to 98% Efficient  
4 Sizes In Stock!  
Takes Propane & 110 Volt



**NAVIEN COMBI BOILER**  
Heat your shop & domestic water all in one unit  
Heats up to 4,000 sq. ft.  
96% Efficient  
Takes Propane & 110 Volt

**NAVIEN - The only tankless heater with dual stainless heat exchangers!!**

**We have some of the most Competitive Wholesale Prices on Boilers & Oxygen Barrier Pex Pipe in the U.S.!**



**Interlocking**

**CREATHERM**  
Radiant Floor Heat Panels  
"Just Walk It In"  
Save up to 50% on install time!  
R-10 Insulation Value, 37 PSI  
For Under Concrete Only



**HEAT TRANSFER PLATE**  
Helps Transfer Heat In  
Sub-Floor Applications



**GRUNDFOS ALPHA 2 PUMP**  
High Efficient, Max 43 Watts, 110 Volts



**DELUXE MANIFOLDS**

**J & R Heating**

7719 E 550 N

Montgomery, IN 47558

Lester & Martha Raber

812-486-3780

Fax 812-486-3890

Ich kann Deutsch!



IF YOU DON'T FIND IT  
IN THE INDEX, LOOK VERY  
CAREFULLY THROUGH THE  
ENTIRE MAGAZINE!

# ADVERTISERS INDEX BY CATEGORY

## Advertiser Name Ad Page

**Animal Health**  
Healzell Inc.....267  
Synergy Animal Products.....193

**Auctions & Real Estate**  
ABC Shop.....202  
Bright Star Realty and Auctions, Inc.....359  
Buckeye Moulding.....217  
Clinic for Special Children.....174  
Country Side Tables.....85  
Country Variety Merchandise Show.....240  
Discover America Tours LLC.....73  
Midwest Tool Auction & Expo.....343  
Sandpiper Homestays LLC.....187  
Westfork Auction & Real Estate LLC.....277

**Books & Educational Products**  
Around The World In 37 Days.....34  
Christian Light Publications.....22  
DISConnected: Leading and Learning Book.....31  
High Desert Press.....294  
Lancaster Puppies.....276  
Masthof Press LLC.....114  
Mattie Lowry.....217  
No Greater Joy Ministries.....114  
Old Country News.....20, 21  
Pequea Publishers.....185  
Perfect Spanish.....330  
Preschool Praises.....267  
Vineyard Publications.....212  
Vintage Volumes.....202

**Building Materials**  
Maple Valley Fence LLC.....160  
AB Martin Roofing Supply.....84  
Airworks Store 3.....92  
Albatross.....186  
A-M Seamless Gutters.....220  
Cedar Ridge Log Home Supply.....248, 294  
Community Supplies.....357  
Country View Enterprise.....135  
Countryside Floors.....266  
Custom Doorcraft.....94  
Daniel Troyer.....44  
Daystar Systems LLC.....392  
Drip Stop.....131  
Esto Leaf Guard.....330  
Etchwood.....361  
Everlast Roofing Inc.....217  
Fern Crest Glueing.....292  
Florhaus.....137  
Hersheys Metal Meister.....178  
JD Cupolas.....311  
Lincdor.....187  
Martin's Farm Supply.....377  
Metal Exteriors.....351  
Mid-South Perma Column.....215  
Moses B Glick LLC.....346  
Mt Hope Planing.....147  
Neil's Roofing.....183  
Paneling Sales.....198  
PCA Products INC.....120  
Premier Doors And Millworks.....360  
RT Wood Products.....378  
Signature Tarp.....170  
Skylight Fabric Structures.....188, 234  
Slate Road Supply LLC.....173, 357

Snow Stoppers LLC.....327  
Stauffer Brothers Flooring.....202  
Stoney Creek Cabins.....172  
TM Supply.....328  
Troyer Roofing & Coating.....82, 83, 302  
Unicus Spray Systems.....187  
Valley Hoop Structures.....308  
Walnut Grove Canvas LLC.....102

**Business Services**  
Darren Brubaker.....369  
PCBE Subscription form.....35

**Business Supplies**  
Dirig Design, Inc.....380

**Clothing**  
Burkholder Country Store.....136  
Coblentz Footwear.....148  
Hamburger Woolen Company.....272

**Construction Tools**  
County Line concepts.....258  
Dalam Welding.....164  
East Coast Drywall Tools INC.....374  
Midwest Tool Auction & Expo.....343  
Stony Point Supply.....271  
Sunrise Leather.....273  
Work Horse Saw Horses.....267

**Cordless Tools**  
Air Works Ltd.....203  
Circuits Alive!.....256  
Graber Farm Building Supply.....179  
Innovative Power LLC.....273  
Keystone Air Power.....7  
Midwest Tool Auction & Expo.....343  
Stoll Brothers.....133  
Yoder Service & Supply.....2

**Diesels & Hydraulics**  
Air-Vac Systems Inc.....378  
AMSOIL.....308  
Beiler Hydraulics Inc.....326  
Central Power Products.....185  
Diesel Engine Service.....365  
Diesel Systems Sales & Sevice.....252  
Donegal Hydraulics LLC.....173  
Evergreen Ag Parts.....73  
Fairview Metalworks.....202  
GD Equipment.....365  
GT Mobile Hydraulics.....327  
HooverTec LLC.....32  
Leid Diesel Service.....365  
Mann Fluid Power Company.....177  
Martin's Electrical Service.....205  
Ohio Valley Engine Repair.....115  
Penn Diesel Service Company.....190  
Power Systems & Supply LLC.....123  
Precision Servo LLC.....368  
Sensenig Diesel Service LLC.....279  
Spring Garden Repair.....275  
Stauffer Diesel.....375  
Troyer Engine.....207  
Xcite Repair.....102  
Yoder Hydraulics.....207, 266

**Dog Supplies**  
Elmer Smucker.....97  
Greenbrier Homestead.....96

Kenton Zimmerman.....378  
New Bedford Feed & Supply.....366

**Dust & Fume Collection**  
Lapp Millwright.....134

**Equipment Rentals**  
Sam's Mechanical Services LLC.....122

**Events**  
Country Side Ag.....322  
Duralast Coatings.....383  
Lengacher Small Engine.....342

**Farm Equipment**  
Ash Supply.....216  
Black Rock Repair.....294  
David M Nolt.....330  
DJS Welding.....136  
Double Oak Enterprises.....37  
Erb & Henry Equip, Inc.....365  
Fairview Metalworks.....202  
Flack Hill Machine.....235  
Gateway Manufacturing.....326  
Harvey Borntreger.....373  
Homestead Equipment.....189  
I&J Manufacturing LLC.....274  
IH Rissler.....342  
Indian Hill Mfg.....268  
JM Shirk MFG.....312  
LK Diesel LLC.....186  
Martin Equipment & Sales.....373  
Matthew Burkholder.....199  
Michiana Equipment.....72  
Millcreek Machine.....220  
Montana Post Driver.....114  
Mullet's Machinery & Parts LLC.....327  
MW Repair & Sales.....311  
Pine Ridge Farm Shop.....366  
Pine View sales.....119  
Pioneer Equipment.....15  
SK Lumber and Building Supply.....253  
Smucker Welding Shop LLC.....274  
Superior Poultry Products LLC.....24  
TH Fabrication.....237  
Troyer Machine.....296  
Zimmerman Tractor.....202

**Farm Supplies**  
Agri-Door.....132  
Agri-Dynamics Inc.....290  
AK Enterprises.....162  
American Eagle Windmills.....135  
Bag Man LLC.....93, 136  
Basic Farm & Home Supply.....358  
Blue Ribbon Vet & Supply.....200  
Blue Ridge Silo LLC.....314  
Community Supplies.....357  
Competitive Commodities LLC.....305  
Conestoga Carts & Wheels.....360  
Drinking Post.....193  
EZ Animal Products.....238  
Falcon Engine Repair.....42  
Farmer Boy Ag.....46  
Fertrell & Company.....250  
Gap View MFG.....365  
Hoffman Hatchery.....330  
Hoover Maple Supplies.....189  
Joe Mescan Windmill.....303  
John's Sharpening Service.....329

Leonard Hostetler.....329  
Lindenhof Blacksmith.....375  
Little Mountain Welding.....356  
M&M Sheet Metal.....266  
Mayhill Supply.....303  
Miller Power Enterprise.....239  
Mountain View Farm Products.....366  
Musser Refrigeration LLC.....251  
Myers Poultry Farm.....364  
Power Scrub Manufacturing.....171  
Pumpkinvine Products.....346  
Redmond Agriculture.....236  
Schlabach Carriage.....360  
Schrocks Feed & Harness.....313  
Solar-In-A-Box Solar Services.....225  
Stoltzfus Welding.....222  
Superior Poultry Products LLC.....25  
Swiss Perfection LLC.....183  
Trail Cruiser.....311  
Trail Farm Supply.....150  
Twin Pine Equipment.....248  
Weavers Compact Tractor.....207  
Zeiset Ag Consulting.....102  
Zimmerman Hay LLC.....177

**Financial Services**  
Anabaptist Foundation.....13  
Anderal Financial.....204  
Crystal Clear Merchant Consultants.....219  
Ellis Group, LLC CPA.....379  
Glenn Financial Services.....164  
JadaPay.....347  
Lester H Beachy CAS.....186  
Merchant Service Consultants.....137

**Forklifts and Supplies**  
Hoover Repair - Forklift certification.....365  
Industrial Tech Service LLC.....232  
Lester Burkholder.....288  
Sam's Mechanical Services LLC.....358  
Wilson Pallet.....219

**Funds**  
Brighter Dawn Retreat.....14  
Christmas Behind Bars.....330  
Heart of Hope India.....216  
We Care Clinic.....165

**Furniture**  
Buck Hollow Woodcraft.....310  
Centerville Wood Products.....216  
Country Bedding MFG LLC.....214  
Farmway Welding.....365  
Heartland Mattress LLC.....23  
Hicks' Clock Shop.....274  
Kountry Wood Products.....106  
Mast Country Sales.....171  
Midwest Turning LLC.....358  
Rock Run Cabinetry.....325  
Timberlane Finish Solutions.....213, 242  
Weaver Wagons & Custom Design LLC.....274

**Furniture Hardware**  
Arthur Distributor Company.....250  
C&A Designs LLC.....292  
Conestoga Woodworking Supply.....170  
Custom Wood Creations.....350  
DM Manufacturing.....314  
E&B Enterprise.....161  
Eichers Furniture Glides.....308

# ADVERTISERS INDEX BY CATEGORY

Faull & Son.....	170
Mid Ohio Sliding Door Components.....	265
Raber Pattern Works.....	314

## Generators

GenTech Generator LLC.....	288
Solar-In-A-Box Solar Services.....	225

## Gift & Crafts

Alaska Adventure Books.....	355
All-Nation Bible Translation.....	184
Andrew King.....	268
Bevanda.....	169
Bowmans Harness Shop LLC.....	296
Christmas Behind Bars.....	242
Country Side Clocks.....	103
Creative Wedding Designs.....	184
Dirt Diggers.....	171
DISConnected: Leading and Learning Book.....	31
Dream Designs Custom Framing.....	9, 13
Dutch Baskets.....	160
Dutch Country Cheese Sales.....	324
Excell Shoes LLC.....	329
Glimpses Of Eden.....	374
Goot Essa.....	65
Idas Gift Shop.....	177
Jonathan Zook (NY).....	137
Jr's Clock Shop.....	248
Kauffman's Store.....	202
Lambright Country Chimes.....	322
Lone Pine Woodworking.....	314
Mary Ellen.....	217
Mattie Lowry.....	217
Michiana Equipment.....	363
MillerTech Energy Solutions.....	54
Nature's Friend.....	374
Oak Lane Books.....	252
Progressive Shoe Store.....	12
Reuben Lantz.....	115
SAMANCO.....	92
Scenic View Variety.....	151
Sunrise Sales.....	151
Sunset Sales.....	106
TGS International.....	54
The Red Shed.....	104
Unlimited Products of Lancaster.....	223

## Greenhouse & Produce Supplies

Adario Sales.....	156
Affordable Lifetime Benching.....	232
Cedar Ridge Sales LLC.....	10
Dinky Flat Filler LLC.....	310
Green Thumb Seeds.....	314
Superior Greenhouse Tables.....	251

## Health & Wellness

Ag USA.....	142, 143
Appalachian Mountain Coffee.....	116
Aquamomics Water.....	94
Becky Hershberger.....	192
Brian-Zarks And Best.....	132
Chupp's Herb Company.....	94, 190
Clara Helmuth.....	222
Crystal Springs Nutrition.....	375
Dan Nisley.....	368
Dry Point Solutions.....	274
EC Health Services.....	252
Eldon & Rachel Kauffman.....	259
Emma Miller.....	266
Green Forest Salves.....	43

Greens For Life.....	49
Health 4 Hope.....	163
Herbal Blends.....	346
Jeffery Hunt DC.....	259
Jerry Fisher.....	378
John Bauman.....	358
Krause Products.....	308
Leah Ruth Stoltzfus.....	328
Lydiann Miller.....	147
Many Words Herbs.....	114
Martin's Orthotics.....	346
Marvin & Mattie Marner.....	171
Massaging Insoles.....	144
Michael Winicki.....	49
Midwest Tool Auction & Expo.....	343
Natural Hope Herbs.....	304
Natural Power Solutions LLC.....	306
Neuro Care.....	323
Nutrition Wellness Center.....	67
Patrick Holland.....	330
Plain Aid Inc.....	198
Plain Brands.....	309
Reign.....	374
Reuben Fisher.....	268
Rocky Meadow Equine.....	161
South River Naturals.....	171
Sun Lite Herbs.....	104
Sunrise Naturals.....	48
Swiss Perfection LLC.....	259
The Water Solution.....	382
Timberview Welding.....	185
True Essential Oils.....	176
UNI Services LLC.....	234
Vista Life.....	158
Willard & Leona Yoder.....	183
Willis Yoder.....	233
Wilma Beechy.....	187
Windy Knoll Machine LLC.....	172
Young Living Oils - Eli Hilty.....	204

## Heating & Cooling

Back Yard Produce.....	206
Bio Mass Energy Techniques.....	278
Blu Flame Heaters LLC.....	92, 162
Blue Sky Components.....	259
Bowmansville Coach.....	170
Bunker Hill Hardware.....	322
DG Electra/cell LLC.....	250
Even Heat Manufacturing.....	350
Farmshop Manufacturing.....	148
Georgetown Sales & Service.....	43
Glenwood Heaters.....	225
Graber Heating Supply.....	376
Hoover Pump Works.....	157
Insulated Pipe Sales.....	314
J&R Heating.....	384
Locust Lane Ltd.....	150
Nash Road Pump & Plumbing.....	202
Solar-In-A-Box Solar Services.....	225
Southern Kentucky Wood Furnace.....	259
Stony Ridge Sales.....	191
Ultimate Outdoor Furnace.....	192

## Help Wanted

H&H Custom Homes.....	94
Lancaster Puppies .Com.....	43
Orr-Lane Builders.....	118

## Horse and Buggy

A&A Carriage Wheel.....	206
-------------------------	-----

Athens Enterprise.....	132
Beechy Buggy Shop.....	214
Benders Buggy Shop.....	234
Biothane Coated Webbing.....	238
Bowmans Harness Shop LLC.....	135
Brodhead Collar Shop.....	200
Carriage Machine LLC.....	200
CDI LLC.....	235
Coblentz Supply.....	266
Cody James Tools.....	158
Dashing Woodworks LLC.....	312
Esh Horse & Pony Blankets.....	273
Fulton County Carriage.....	207
Gateway Sales (ON).....	184
Hillside Harness Hardware.....	340
Hillside Metals & Supply.....	185
Hoovers Furniture.....	319
Larry Zimmerman.....	358
Lindenof Blacksmith Shop.....	150
Mark Walling Mfg.....	273
Martin's Bicycle.....	216
Mid River Sales.....	201
Mohawk Valley Coach Shop.....	33
Mountain View Harness.....	100
N&A Harness Shop.....	107
Nickel Mine Coach Shop.....	267
NoIt Wagon Works.....	122
Raymond Yoder.....	255
Schwartz Farrier Supplies.....	340
Sugar Valley Collar Shop.....	279
Sunset Supply LLC.....	224
Super Weave.....	175
Tri Z Power.....	120
Troyer Machine.....	266
Weststar Enterprise.....	150

## Household Supplies

Bargain Max.....	148
Blue Iron Metal Works.....	256
Buckeye Blanket.....	258
Bunker Hill Appliance.....	310
Burkholder Country Store.....	136
C&M Maytag.....	234
Cardinal Hollo Repair.....	144, 220
Chemical Solvents Inc.....	132
Clark Casting LLC.....	289
Cleon Martin.....	248
Creative Holmes.....	117
Creative PowerCell-utions.....	271
CutCo.....	146
DISConnected: Leading and Learning Book.....	31
DJM Sales.....	265
Dutch Country Grains.....	73
Eagle Food Equipment.....	186
Family Creations.....	162
Farmerstown Shoe & Gift.....	365
Fisher Manufacturing.....	338
Flying Eagle Hats.....	310
Georgetown Sales & Service.....	9, 182
Happy Mom's Diapering.....	206
Heartland Polymer Cabinets.....	148
Holmes Surplus Center.....	100
Homeplace Market Wagon.....	146
Imagine Machining.....	190
Karen Mast.....	217
King's Sales & Service.....	159
Kuhns Welding.....	344
Living Waters.....	269
LOK General Store LLC.....	350
M&L Appliance and Repair.....	236

Martin's Electric.....	206
Michiana Equipment.....	362
MillerTech Energy Solutions.....	55, 59
Musser Refrigeration LLC.....	364
Nelson Yoder.....	207
Park View Shades.....	303
Riverbend Fabrics & Variety Store.....	259
Rockwood Repair.....	340
Rosewood Coffee Roasters.....	221
S&S Manufacturing & Welding.....	303
Scenic View Engine LLC.....	191
Schlabach Engine.....	41
SE Drive Shafts.....	367
Skyline Enterprises.....	303
Sunrise Metal Shop.....	314
Sunrise Solutions.....	304
Tater Turbo.....	119
Top Stitch Sewing Service LLC.....	221
Train View Window and Door.....	104
Westmark Corporation.....	177
Wilma Beechy.....	187

## Hunting & Outdoor Recreation

Back Country Optics.....	212
Benton Bow Shop.....	156
Clearview Optics.....	252
Dogwood Ridge Outdoors.....	343
Ed's Outdoor Store.....	148
Ed's Vortex Supplies.....	329
Hoss.....	360
Jonathan Burkholder.....	379
Night Eyes.....	198
Quality Archery.....	368
Smokey's Deer Lure.....	248

## Lawn & Garden

A K Small Engines LLC.....	146
AB Repair.....	157
C L Martin Small Engine.....	199
Cedar Ridge Mfg. LLC.....	338
Charm Engine LTD.....	46
Dutch Boy Assembled Furniture.....	296
Dutch Garden Nursery.....	135
Evergreen Lawn & Garden.....	130
Family Firesides.....	342
Kuhns Power Equipment.....	295
Lambright Country Chimes.....	322
Nickel Mine Welding.....	379
Peachey's Sharpening and Sales.....	343
Premier Lawn & Garden.....	241
Reliable Power Inc.....	364
RH Assembly LLC.....	364
Sauder Farm Country Market.....	330
Schlabach Engine.....	192
Sidekick Products.....	145
Valley Road Woodworks LLC.....	241

## Lighting

Alron Integrity Sales LLC.....	136
Bender Off-Grid Solutions.....	339
Borntreger Sales.....	159
Burkholder Country Store.....	136
Creative PowerCell-utions.....	243
Geo Lighting.....	103
Glenn Ray Mullet.....	322
HC Lanterns.....	183, 206, 272
Heartland Enterprise LLC.....	220
Homestead Lights.....	373
Ideal Electronics.....	254
KC Innovations.....	149



# ADVERTISERS INDEX BY CATEGORY

Keystone Battery Solutions .....	176	Lester H Beachy CAS .....	186	MAX POTENTIAL SYSTEMS, LLC .....	259	Sam's Mechanical Services LLC .....	122
Lakeside Illuminations .....	147	Perfect Spanish .....	330	MAYKO PRODUCTS LLC .....	250	Samuel Miller .....	364
Lancaster Lanterns .....	333	Pioneer Electronics .....	235	Mckinley Advertising LLC .....	342	Zimmerman Skidloader .....	215
Mid Ohio Lighting .....	192	Plain Connect .....	312	Mil-Tek Rubber .....	346		
MillerTech Energy Solutions .....	56, 57, 58	Plain Tech .....	292	M-Tech .....	72, 107	<b>Solar Energy &amp; Supplies</b>	
North American Lantern Fuel .....	368	Pleasant Word Processor .....	311	PalmTec Travel .....	10	Central Lighting .....	178
Ray Bontrager .....	279	Print Wares .....	328	Picture It Engraving .....	201	Circuits Alive! .....	256
Sunrise Circuits .....	304	Solar-In-A-Box Solar Services .....	225	Purple Daisy Design .....	330	Connect Wholesale .....	268
West Ridge Supply .....	177	Starlux Illumination .....	267	Robertson Insurance & Risk Management .....	251	Hilty's Radiant Energy LLC .....	137
Wickeys Handy Dandy LLC .....	104	Sun Lite Enterprise LLC .....	307	Rosewood Marketing .....	263	Martin's Electrical Service .....	207, 369
		Sunnyburn Machine Works .....	237	Ross Enterprises, LLC .....	159	Midwest Tool Auction & Expo .....	343
<b>Logging</b>		Syftkog Wireless .....	172	Stephen Aguilar .....	237	MillerTech Energy Solutions .....	60, 61
Ben Jones .....	218	Think Ink .....	391	Tri State Grinding .....	237	RenuEnergy .....	145
Precision Power Equipment .....	147	Typewriter Sales .....	118	Truax Printing INC .....	113	Slaymaker Electric Motor & Supply Co .....	382
		Venture Products .....	273	Verve Marketing & Design .....	239	Solar Freeze LLC .....	344
<b>Lumber</b>		Walmer Communications .....	341			Solar-In-A-Box Solar Services .....	225
Green Fox Plastics .....	319	Yoder's Connections LLC .....	345	<b>Rebar &amp; Wire</b>		Trail Battery and Solar .....	279
Lewis & Hockenberry Inc .....	311			Quality Wire Forming .....	308	Tri Z Power .....	249
Quality Timbers & Wood Products LLC .....	151	<b>Packing &amp; Shipping Supplies</b>				WS Wholesale LLC .....	257
Ralph Stuck Lumber .....	314	Ee Zee Wrapper .....	292	<b>Rentals</b>		Zonna .....	128
River Valley Pine .....	224	Interpack Systems .....	310	Cozy Oaks .....	95	Zonna Energy .....	129
		Interstate Fleets Services .....	160				
<b>Metal Working</b>		JRS Ag Assemblies LLC .....	296	<b>Roofing</b>		<b>Strapping &amp; Banding</b>	
A&A Machine Co. ....	148	McGregor Packaging .....	349	Daniel Troyer .....	45	Interpack Systems .....	310
Acu-Form .....	95			Duane Bontrager .....	11	McGregor Packaging .....	349
Arrowhead Manufacturing LLC .....	170	<b>Paints &amp; Finishing Supplies</b>		Hawkeye Enterprise .....	47		
B&M Welding Inc .....	278	A&L Paint Company .....	390	Masterpiece Metals .....	372	<b>Trailers</b>	
City Hill Fabricating LLC .....	135	Conestoga Woodworking Supply .....	206	Solar-In-A-Box Solar Services .....	225	Derstine Trailer Works LLC .....	85
Community Supplies .....	357	Final Touch Finishing .....	357	Sunrise Enterprises .....	343	Musser Refrigeration LLC .....	328
DS Stoves .....	66	Finish Works LLC .....	200			Royal Metal Works .....	254
Ecenrode Welding Supplies .....	3	Grapek Bates .....	32, 255	<b>Safety</b>			
Fairview Metalworks .....	202	Hentzen Coatings Inc .....	234	Cycle Works .....	254	<b>Upholstery</b>	
Forest Manufacturing .....	73	S&M Enterprise .....	251	Fire Pro .....	193	Heartland Fabrics LLC .....	108, 109
Four Star Welding .....	261	Specialty Paints & Coatings .....	116, 274	G&S Glove .....	12		
Fusion Bolts & Machine .....	259	Woodwright .....	102			<b>Vehicles</b>	
Green Valley Metal Works .....	177	Zimmerman Auto Body Supplies Inc .....	233	<b>Sawmill &amp; Pallet Shop Machinery</b>		Barons Bus Service .....	217
Heartland Sales & Machine LLC .....	292			Ben Jones .....	218		
Hersheys Metal Meister .....	36	<b>Plastic Fabrication</b>		Brute Force .....	146	<b>Woodworking Machinery</b>	
Hilltop Welding .....	23	Accu-Shape Plastics LLC .....	157	Coblentz Fabrication .....	340	Air-Vac Systems Inc .....	92
Iron Bull .....	315	Jaylor Plastic .....	105	Conrad Bates .....	155	American Wide Belt Sander .....	175
M&L Designs .....	364	Nighthawk 3D .....	151	EZ Boardwalk .....	224	Associated Machinery Sales .....	254
Maple River Machine .....	235	Quality Plastics LLC .....	297	Frost Mountain Woodshop .....	175	AW Machinery .....	231
McGregor Packaging .....	349	Vecoplan .....	205	Ideal Manufacturing LLC .....	379	BDH Belts .....	293
Metal Rollforming Systems .....	357			Mighty Ox Equipment LLC .....	265	Blue Iron Metal Works .....	312
Pioneer Equipment .....	101	<b>Plumbing</b>		Northwood Sharpening .....	308	Buckeye Welding & Mfg .....	376
Precision Metal Craft LLC .....	369	Custom Cast Ltd .....	272	Pendu Manufacturing Inc .....	193	Byler Industrial Tool & Supply .....	327
Quality Wire Forming .....	308			Sawmill Exchange .....	217	Conestoga Woodworking Supply .....	148, 273
Raytec Fabricating LLC .....	165	<b>Printing &amp; Promotional Products</b>		Showcase Equipment .....	261	Custom Wood Products .....	294
Schwartz Welding Equipment, LLC .....	190	Boyer Printing & Promotional LLC .....	202	Smith Sawmill Service, LLC .....	236, 381	Dust Pro .....	43
SideKick Attachments .....	270	Fuze Designs .....	314	Timber Buddy Sawmills .....	159	Hamilton Tool and Supply Company .....	291
Star 1 Products .....	272	Hurst Embroidery .....	310	Valley Machine & Fab .....	106	Hernance Machine Company .....	348
Stoll Metalworks .....	375	IdentiGrow .....	201	Weaver Engine Shop .....	364	Hershberger Mfg. and Sales .....	258
Stoll Steel Buildings .....	163	Inkscape Print & Promos LLC .....	105, 201			Hoover Repair .....	130
Swenson Shear .....	260	Little Mountain Printing .....	222	<b>Shelving</b>		HOSS Woodworking Tooling & Supplies .....	365
Teck Machine .....	221	M-Tech .....	267	Sam's Mechanical Services LLC .....	122	Jamison Sharpening .....	350
TruPoint Products LLC .....	172	SAMANNCO .....	273	Troyer Wholesale .....	221	Lapp Millwright .....	134
Valley Fabrication and Welding .....	356	Truax Printing INC .....	113			Martin's Woodworking Machinery .....	240
Weaver Machine & Hardware .....	163			<b>Skid Loaders &amp; Attachments</b>		Mereen-Johnson LLC .....	240
Weaver Metalworking Machinery .....	307	<b>Professional Services</b>		Burkholder Equipment .....	278	Midwest Tool Auction & Expo .....	343
Yoder's Produce .....	225	Ark Precision Cutting LLC .....	235	Burkholder Skidloader Sales LLC .....	289	Millcreek Machine .....	177
		Back Forty Creative .....	70, 71	Creekside Welding LLC .....	162	Miller Machine Shop .....	257
<b>Office Supplies &amp; Electronics</b>		Black Anvil Media .....	30	DA Hochstetler .....	8	MVM Tool Industries LLC .....	368
Altech Enterprises .....	200	Cad By Karl .....	224	DJ'S General Repair .....	278	Oak Lawn Blade Sales and Service .....	273
Aunt Barbies .....	121	Caleb Crider .....	99	Fairview Metalworks .....	202	Panto Router .....	123
Classis Steward Word Processor .....	234	Chris Hartford Travel .....	308	J&J Welding & Metal Fabrication .....	37	Pine Valley Bolts and Hardware .....	331
Country Cellular LLC .....	328	CodeCrafters USA, Inc .....	332	Kivel Manufacturing .....	191	Production Abrasives, Inc .....	236
Custom Laser Engraving .....	225	Debra Boyer .....	157	Martin Equipment & Sales .....	235	Riehl Steel LLC .....	177
Daylight Power Solutions LLC .....	342	Gehman Accounting Inc .....	33, 37	Nathan Troyer .....	217	Topp line Incorporated .....	33
Eagle Ridge Enterprise LLC .....	121	Gehman Business Advisors .....	49	North Central Assemblies LLC .....	122, 161	Vessel Tools USA INC .....	324
Home Office Resource .....	329	Just Plain Business .....	311	Overdrive Tool .....	305	Woodwork Productions .....	175
Indian Trail Tax Prep .....	163	Lyndo Design .....	175	Robert Yoder .....	343	Yoder Sales .....	330

# ADVERTISERS INDEX BY NAME

Company Name	Index Page	Company Name	Index Page	Company Name	Index Page
A K Small Engines LLC	146	Blue Sky Components	259	Countryside Floors	266
A&A Carriage Wheel	206	Borntrager Sales	159	County Line concepts	258
A&A Machine Co.	148	Bowmans Harness Shop LLC	135, 296	Cozy Oaks	95
A&L Paint Company	390	Bowmansville Coach	170	Creative Holmes	117
AB Martin Roofing Supply	84	Boyer Printing & Promotional LLC	202	Creative PowerCell-utions	243, 271
AB Repair	157	Brian-Zarks And Best	132	Creative Wedding Designs	184
ABC Shop	202	Bright Star Realty and Auctions, Inc.	359	Creekside Welding LLC	162
Accu-Shape Plastics LLC	157	Brighter Dawn Retreat	14	Crystal Clear Merchant Consultants	219
Accu-Form	95	Brodhead Collar Shop	200	Crystal Springs Nutrition	375
Adario Sales	156	Brute Force	146	Custom Cast Ltd.	272
Affordable Lifetime Benching	232	Buck Hollow Woodcraft	310	Custom Doorcraft	94
Ag USA	142, 143	Buckeye Blanket	258	Custom Laser Engraving	225
Agri-Door	132	Buckeye Moulding	217	Custom Wood Creations	350
Agri-Dynamics Inc.	290	Buckeye Welding & Mfg.	376	Custom Wood Products	294
Air Works Ltd.	203	Bunker Hill Appliance	310	CutCo	146
Air-Vac Systems Inc.	92, 378	Bunker Hill Hardware	322	Cycle Works	254
Airworks Store 3	32	Burkholder Country Store	136	DA Hochstetler	8
AK Enterprises	162	Burkholder Equipment	278	Dalam Welding	164
Alaska Adventure Books	355	Burkholder Skidloader Sales LLC	289	Dan Nisley	368
Albatross	186	Byler Industrial Tool & Supply	327	Daniel Troyer	44, 45
All-Nation Bible Translation	184	C L Martin Small Engine	199	Darren Brubaker	369
Alron Integrity Sales LLC	136	C&A Designs LLC	292	Dashing Woodworks LLC	312
Altech Enterprises	200	C&M Maytag	234	David M Nolt	330
A-M Seamless Gutters	220	Cad By Karl	224	Daylight Power Solutions LLC	342
American Eagle Windmills	135	Caleb Crider	99	Daystar Systems LLC	392
American Wide Belt Sander	175	Cardinal Hollo Repair	144, 220	Debra Boyer	157
AMSOIL	308	Carriage Machine LLC	84	Derstine Trailer Works LLC	85
Anabaptist Foundation	13	CDI LLC	235	DG Electra/cell LLC	250
Anderal Financial	204	Cedar Ridge Log Home Supply	248, 294	Diesel Engine Service	365
Andrew King	268	Cedar Ridge Mfg. LLC	338	Diesel Systems Sales & Service	252
Appalachian Mountain Coffee	116	Cedar Ridge Sales LLC	10	Dinky Flat Filler LLC	310
Aquamonics Water	94	Centerville Wood Products	216	Dirig Design, Inc.	380
Ark Precision Cutting LLC	235	Central Lighting	178	Dirt Diggers	171
Around The World In 37 Days	34	Central Power Products	185	DISConnected: Leading and Learning Book	31
Arrowhead Manufacturing LLC	170	Charm Engine LTD	46	Discover America Tours LLC	73
Arthur Distributor Company	250	Chemical Solvents Inc.	132	DJM Sales	265
Ash Supply	216	Chris Hartford Travel	308	DJS General Repair	278
Associated Machinery Sales	254	Christian Light Publications	22	DJS Welding	136
Athens Enterprise	132	Christmas Behind Bars	242, 330	DM Manufacturing	314
Aunt Barbies	121	Chupp's Herb Company	94, 190	Dogwood Ridge Outdoors	343
AW Machinery	231	Circuits Alive!	256	Donegal Hydraulics LLC	173
B&M Welding Inc.	278	City Hill Fabricating LLC	135	Double Oak Enterprises	37
Back Country Optics	212	Clara Helmut	222	Dream Designs Custom Framing	9, 13
Back Forty Creative	70, 71	Clark Casting LLC	289	Drinking Post	193
Back Yard Produce	206	Classifieds	320 - 321	Drip Stop	131
Bag Man LLC	93, 136	Classis Steward Word Processor	234	Dry Point Solutions	274
Bargain Max	148	Clearview Optics	252	DS Stoves	66
Barons Bus Service	217	Cleon Martin	248	Duane Bontrager	11
Basic Farm & Home Supply	358	Clinic for Special Children	174	Duralast Coatings	383
BDH Belts	293	Coblentz Fabrication	340	Dust Pro	43
Becky Hershberger	192	Coblentz Footwear	148	Dutch Baskets	160
Beechy Buggy Shop	214	Coblentz Supply	266	Dutch Boy Assembled Furniture	296
Beiler Hydraulics Inc.	326	CodeCrafters USA, Inc.	332	Dutch Country Cheese Sales	324
Ben Jones	218	Cody James Tools	158	Dutch Country Grains	73
Bender Off-Grid Solutions	339	Community Supplies	357	Dutch Garden Nursery	135
Benders Buggy Shop	234	Competitive Commodities LLC	305	E&B Enterprise	161
Benton Bow Shop	156	Conestoga Carts & Wheels	360	Eagle Food Equipment	186
Bevanda	169	Conestoga Woodworking Supply	248, 170, 206, 273	Eagle Ridge Enterprise LLC	121
Bio Mass Energy Techniques	278	Connect Wholesale	268	East Coast Drywall Tools INC	374
Biothane Coated Webbing	238	Conrad Bates	155	EC Health Services	252
Black Anvil Media	30	Country Bedding MFG LLC	214	Ecenrode Welding Supplies	3
Black Rock Repair	294	Country Cellular LLC	328	Ed's Outdoor Store	148
Blu Flame Heaters LLC	92, 162	Country Side Ag	322	Ed's Vortex Supplies	329
Blue Iron Metal Works	256, 312	Country Side Clocks	103	Ee Zee Wrapper	292
Blue Ribbon Vet & Supply	200	Country Side Tables	85	Eichers Furniture Glides	308
Blue Ridge Silo LLC	314	Country Variety Merchandise Show	240	Eldon & Rachel Kauffman	259
		Country View Enterprise	135	Ellis Group, LLC CPA	379
				Elmer Smucker	97
				Emma Miller	266
				Erb & Henry Equip, Inc	365
				Esh Horse & Pony Blankets	273
				Esto Leaf Guard	330
				Etchwood	361
				Even Heat Manufacturing	350
				Evergreen Ag Parts	73
				Evergreen Lawn & Garden	130
				Everlast Roofing Inc	217
				Excell Shoes LLC	329
				EZ Animal Products	238
				EZ Boardwalk	224
				Fairview Metalworks	202
				Falcon Engine Repair	42
				Family Creations	162
				Family Firesides	8
				Farmer Boy Ag	46
				Farmerstown Shoe & Gift	365
				Farmshop Manufacturing	148
				Farmway Welding	365
				Faull & Son	170
				Fern Crest Glueing	292
				Fertrell & Company	250
				Final Touch Finishing	357
				Finish Works LLC	200
				Fire Pro	193
				Fisher Manufacturing	338
				Flack Hill Machine	235
				Florhaus	137
				Flying Eagle Hats	310
				Forest Manufacturing	73
				Four Star Welding	261
				Frost Mountain Woodshop	175
				Fulton County Carriage	207
				Fusion Bolts & Machine	259
				Fuze Designs	314
				G&S Glove	12
				Gap View MFG	365
				Gateway Manufacturing	326
				Gateway Sales (ON)	184
				GD Equipment	365
				Gehman Accounting Inc.	33, 37
				Gehman Business Advisors	49
				GenTech Generator LLC	288
				Geo Lighting	103
				Georgetown Sales & Service	9, 43, 182
				Glenn Financial Services	164
				Glenn Ray Mullet	322
				Glenwood Heaters	225
				Glimpes Of Eden	374
				Goot Essa	65
				Graber Farm Building Supply	179
				Graber Heating Supply	376
				Grapek Bates	32, 255
				Green Forest Salves	43
				Green Fox Plastics	319
				Green Thumb Seeds	314
				Green Valley Metal Works	177
				Greenbrier Homestead	96
				Greens For Life	49
				GT Mobile Hydraulics	327
				H&H Custom Homes	94
				Hamburger Woolen Company	292
				Hamilton Tool and Supply Company	291
				Happy Mom's Diapering	206
				Harvey Borntrager	373
				Hawkeye Enterprise	47
				HC Lanterns	183, 206, 272
				Health 4 Hope	163
				HealZall Inc	267
				Heart of Hope India	216
				Heartland Enterprise LLC	220
				Heartland Fabrics LLC	108, 109
				Heartland Mattress LLC	23
				Heartland Polymer Cabinets	148
				Heartland Sales & Machine LLC	292
				Hentzen Coatings Inc	234
				Herbal Blends	346
				Hermance Machine Company	348
				Hershberger Mfg. and Sales	258
				Hersheys Metal Meister	36, 178
				Hicks' Clock Shop	274
				High Desert Press	294
				Hillside Harness Hardware	340
				Hillside Metals & Supply	185
				Hilltop Welding	23
				Hilty's Radiant Energy LLC	137
				Hoffman Hatchery	330
				Holmes Surplus Center	100
				Home Office Resource	329
				Homeplace Market Wagon	146
				Homestead Equipment	189
				Homestead Lights	373
				Hoover Maple Supplies	189
				Hoover Pump Works	157
				Hoover Repair	130
				Hoover Repair - Forklift certification	365
				Hoovers Furniture	319
				HooverTec LLC	32
				Hoss	360
				HSS Woodworking Tooling & Supplies	365
				Hurst Embroidery	310
				I&J Manufacturing LLC	274
				Idas Gift Shop	177
				Ideal Electronics	254
				Ideal Manufacturing LLC	379
				Identigrow	201
				IH Rissler	342
				Imagine Machining	190
				Indian Hill Mfg	268
				Indian Trail Tax Prep	163
				Industrial Tech Service LLC	232
				Inkscape Print & Promos LLC	105, 201
				Innovative Power LLC	273
				Insulated Pipe Sales	314
				Interpack Systems	310
				Interstate Fleets Services	160
				Iron Bull	315
				J&J Welding & Metal Fabrication	37
				J&R Heating	384
				JadaPay	347
				Jamison Sharpening	350
				Jaylor Plastic	105
				JD Cupolas	311
				Jeffery Hunt DC	259
				Jerry Fisher	378
				JM Shirk MFG	312
				Joe Mescan Windmill	303
				John Bauman	358
				John's Sharpening Service	329
				Jonathan Burkholder	379
				Jonathan Zook (NY)	137
				JRS Ag Assemblies LLC	296



# ADVERTISERS INDEX BY NAME

Jr's Clock Shop.....248	Mckinley Advertising LLC.....342	Perfect Spanish.....330	Schwartz Welding Equipment, LLC.....190	Trail Cruiser.....311
Just Plain Business.....311	Merchant Service Consultants.....137	Picture It Engraving.....201	SE Drive Shafts.....367	Trail Farm Supply.....150
Karen Mast.....217	Mereen-Johnson LLC.....240	Pine Ridge Farm Shop.....366	Sensenig Diesel Service LLC.....279	Train View Window and Door.....104
Kauffman's Store.....202	Metal Exteriors.....351	Pine Valley Bolts and Hardware.....331	Showcase Equipment.....261	Tri State Grinding.....237
KC Innovations.....149	Metal Rollforming Systems.....357	Pine View sales.....119	SideKick Attachments.....270	Tri Z Power.....120, 249
Kenton Zimmerman.....378	Michael Winicki.....49	Pioneer Electronics.....235	Sidekick Products.....145	Troyer Engine.....207
Keystone Air Power.....7	Michiana Equipment.....72, 362, 363	Pioneer Equipment.....15, 101	Signature Tarp.....170	Troyer Machine.....266, 296
Keystone Battery Solutions.....176	Mid Ohio Lighting.....192	Plain Aid Inc.....309	SK Lumber and Building Supply.....253	Troyer Roofing & Coating.....82, 82, 302
King's Sales & Service.....159	Mid Ohio Sliding Door Components.....265	Plain Brands.....308	Skylight Fabric Structures.....188, 234	Troyer Wholesale.....221
Kivel Manufacturing.....191	Mid River Sales.....201	Plain Connect.....312	Skyline Enterprises.....303	Truax Printing INC.....113
Kountry Wood Products.....106	Mid-South Perma Column.....215	Plain Tech.....292	Slate Road Supply LLC.....173, 357	True Essential Oils.....176
Krause Products.....308	Midwest Tool Auction & Expo.....343	Pleasant Word Processor.....311	Slaymaker Electric Motor & Supply Co.....382	TruPoint Products LLC.....172
Kuhns Power Equipment.....295	Midwest Turning LLC.....358	Power Scrub Manufacturing.....171	Smith Sawmill Service, LLC.....236, 381	Twin Pine Equipment.....248
Kuhns Welding.....344	Mighty Ox Equipment LLC.....265	Power Systems & Supply LLC.....123	Smokey's Deer Lure.....248	Typewriter Sales.....118
Lakeside Illuminations.....147	Millcreek Machine.....177, 220	Precision Metal Craft LLC.....369	Smucker Welding Shop LLC.....274	Ultimate Outdoor Furnace.....192
Lambright Country Chimes.....322	Miller Machine Shop.....257	Precision Power Equipment.....147	Snow Stoppers LLC.....327	UNI Services LLC.....234
Lancaster Lanterns.....333	Miller Power Enterprise.....239	Precision Servo LLC.....368	Solar Freeze LLC.....344	Unicus Spray Systems.....187
Lancaster Puppies.....276	MillerTech Energy Solutions.....54 - 61	Premier Doors And Millworks.....360	Solar-In-A-Box Solar Services.....225	Unlimited Products of Lancaster.....223
Lancaster Puppies.Com.....43	Mil-Tek Rubber.....346	Premier Lawn & Garden.....241	South River Naturals.....171	Valley Fabrication and Welding.....356
Lapp Millwright.....134	Mohawk Valley Coach Shop.....33	Preschool Praises.....267	Southern Kentucky Wood Furnace.....259	Valley Hoop Structures.....308
Larry Zimmerman.....358	Montana Post Driver.....114	Print Wares.....328	Specialty Paints & Coatings.....116, 274	Valley Machine & Fab.....106
Leah Ruth Stoltzfus.....328	Moses B Glick LLC.....346	Production Abrasives, Inc.....236	Spring Garden Repair.....275	Valley Road Woodworks LLC.....241
Leid Diesel Service.....365	Mountain View Farm Products.....366	Progressive Shoe Store.....12	Star 1 Products.....272	Vecoplan.....205
Lengacher Small Engine.....342	Mountain View Harness.....100	Pumpkinvine Products.....346	Starlux Illumination.....267	Venture Products.....273
Leonard Hostetler.....329	Mt Hope Planing.....147	Purple Daisy Design.....330	Stauffer Brothers Flooring.....202	Verve Marketing & Design.....239
Lester Burkholder.....288	M-Tech.....72, 107, 267	Quality Archery.....368	Stauffer Diesel.....375	Vessel Tools USA INC.....324
Lester H Beachy CAS.....186	Mullet's Machinery & Parts LLC.....327	Quality Plastics LLC.....297	Stephen Aguilar.....237	Vineyard Publications.....212
Lewis & Hockenberry Inc.....311	Musser Refrigeration LLC.....251, 328, 364	Quality Timbers & Wood Products LLC.....151	Stoll Brothers.....133	Vintage Volumes.....202
Lincoln.....187	MVM Tool Industries LLC.....368	Quality Wire Forming.....308	Stoll Metalworks.....375	Vista Life.....158
Lindenhof Blacksmith.....375	MW Repair & Sales.....311	Raber Pattern Works.....314	Stoll Steel Buildings.....163	Walmer Communications.....341
Lindenhof Blacksmith Shop.....150	Myers Poultry Farm.....364	Ralph Stuck Lumber.....314	Stoltzfus Welding.....222	Walnut Grove Canvas LLC.....102
Little Mountain Printing.....222	N&A Harness Shop.....107	Ray Bontrager.....279	Stoney Creek Cabins.....172	We Care Clinic.....165
Little Mountain Welding.....356	Nash Road Pump & Plumbing.....202	Raymond Yoder.....255	Stony Point Supply.....271	Weaver Engine Shop.....364
Living Waters.....269	Nathan Troyer.....217	Raytec Fabricating LLC.....165	Stony Ridge Sales.....191	Weaver Machine & Hardware.....163
LK Diesel LLC.....186	Natural Hope Herbs.....304	Bedmond Agriculture.....236	Sugar Valley Collar Shop.....279	Weaver Metalworking Machinery.....307
Locust Lane Ltd.....150	Natural Power Solutions LLC.....306	Reign.....374	Sun Lite Enterprise LLC.....307	Weaver Wagons & Custom Design LLC.....274
LOK General Store LLC.....350	Nature's Friend.....374	Reliable Power Inc.....364	Sun Lite Herbs.....104	Weavers Compact Tractor.....207
Lone Pine Woodworking.....314	Neil's Roofing.....183	RenuEnergy.....145	Sunnyburn Machine Works.....237	West Ridge Supply.....177
Lydiann Miller.....147	Nelson Yoder.....207	Reuben Fisher.....268	Sunrise Circuits.....304	Westfork Auction & Realestate LLC.....277
Lyndo Design.....175	Neuro Care.....323	Reuben Lantz.....115	Sunrise Enterprises.....343	Westmark Corporation.....177
M&L Appliance and Repair.....236	New Bedford Feed & Supply.....366	RH Assembly LLC.....364	Sunrise Leather.....273	Weststar Enterprise.....150
M&L Designs.....364	Nickel Mine Coach Shop.....267	Riehl Steel LLC.....177	Sunrise Metal Shop.....314	Wickeys Handy Dandy LLC.....104
M&M Sheet Metal.....266	Nickel Mine Welding.....379	River Valley Pine.....224	Sunrise Naturals.....48	Willard & Leona Yoder.....183
Machinery Trader.....208 - 287	Night Eyes.....198	Riverbend Fabrics & Variety Store.....259	Sunrise Sales.....151	Willis Yoder.....233
Mann Fluid Power Company.....177	Nighthawk 3D.....151	Robert Yoder.....343	Sunrise Solutions.....304	Wilma Beechy.....187
Many Words Herbs.....114	No Greater Joy Ministries.....114	Robertson Insurance & Risk Management.....251	Sunset Sales.....106	Wilson Pallet.....219
Maple River Machine.....235	Nolt Wagon Works.....122	Rock Run Cabinetry.....325	Sunset Supply LLC.....224	Windy Knoll Machine LLC.....172
Maple Valley Fence LLC.....160	North American Lantern Fuel.....368	Rockvale Repair.....340	Super Weave.....175	Woodwork Productions.....175
Mark Walling Mfg.....273	North Central Assemblies LLC.....122, 161	Rocky Meadow Equine.....161	Superior Greenhouse Tables.....251	Woodwright.....102
Martin Equipment & Sales.....235, 373	Northwood Sharpening.....308	Rosewood Coffee Roasters.....221	Superior Poultry Products LLC.....24, 25	Work Horse Saw Horses.....267
Martin's Bicycle.....216	Nutrition Wellness Center.....67	Rosewood Marketing.....263	Swenson Shear.....260	WS Wholesale LLC.....257
Martin's Electric.....206	Oak Lane Books.....252	Ross Enterprises, LLC.....183, 259	Swiss Perfection LLC.....183, 259	Xcite Repair.....102
Martin's Electrical Service.....205, 207, 369	Oak Lawn Blade Sales and Service.....273	Royal Metal Works.....172	Syftkog Wireless.....172	Yoder Hydraulics.....207, 266
Martin's Farm Supply.....377	Ohio Valley Engine Repair.....115	RT Wood Products.....378	Synergy Animal Products.....193	Yoder Sales.....330
Martin's Orthotics.....346	Old Country News.....20, 21	S&M Enterprise.....251	Tater Turbo.....119	Yoder Service & Supply.....2
Martin's Woodworking Machinery.....240	Orr-Lane Builders.....118	S&S Manufacturing & Welding.....303	Teck Machine.....221	Yoder's Connections LLC.....345
Marvin & Mattie Marner.....171	Overdrive Tool.....305	SAMANCO.....92, 273	The Water Solution.....382	Yoder's Produce.....225
Mary Ellen.....217	PalmTec Travel.....10	Sam's Mechanical Services LLC.....122, 358	Think Ink.....391	Young Living Oils - Eli Hilty.....204
Massaging Insoles.....144	Paneling Sales.....198	Samuel Miller.....364	Timber Buddy Sawmills.....159	Zeiset Ag Consulting.....102
Mast Country Sales.....171	Panto Router.....123	Sandpiper Homestays LLC.....187	Timberlane Finish Solutions.....213, 242	Zimmerman Auto Body Supplies Inc.....233
Masterpiece Metals.....372	Park View Shades.....303	Sauder Farm Country Market.....330	Timberview Welding.....185	Zimmerman Hay LLC.....177
Masthof Press LLC.....114	Patrick Holland.....330	Sawmill Exchange.....217	TM Supply.....328	Zimmerman Skidloader.....215
Matthew Burkholder.....199	PCA Products INC.....120	Scenic View Engine LLC.....191	Top Stitch Sewing Service LLC.....221	Zimmerman Tractor.....202
Mattie Lowry.....217	PCBE Subscription form.....35	Scenic View Variety.....151	Topp line Incorporated.....33	Zonna.....128
MAX POTENTIAL SYSTEMS, LLC.....259	Peachey's Sharpening and Sales.....343	Schlabach Carriage.....360	Trail Battery and Solar.....279	Zonna Energy.....129
Mayhill Supply.....303	Pendu Manufacturing Inc.....190	Schlabach Engine.....41, 192		
MAYKO PRODUCTS LLC.....250	Penn Diesel Service Company.....193	Schrocks Feed & Harness.....313		
McGregor Packaging.....349	Pequea Publishers.....185	Schwartz Farrier Supplies.....340		

# Tired of sticky cabinets?

Water-borne Urethane applies easily with very low odor.

The NaturalKote Urethane finish on sink cabinets (below), after 4½ years shows no sign of stickiness or water damage, and maintains a beautifully smooth finish. They still clean as easily as when they were new.

*Handle shows wear, but the finish does not!*



## NaturalKote™ Water-borne Urethane

- High Build
- Durable Finish
- Non Flammable
- Can be recoated in 1 hour
- Will not get sticky with age
- Easy Spraying and Brushing



We offer a full line of coatings, sundries and spray equipment.

**GRACO**  
Sales & Service

Custom Spray Systems



GMax 3400



Graco 390 Cordless

- Competitive pricing retail and wholesale
- Ask about free shipping
- Delivery to most of the nation in 1 to 3 days



**Paint Co., LLC**

112 Four Wheel Drive, Suite 2 • Rebersburg, PA 16872

**1.888.980.9796**

*Call for free color samples*



# BUNDLE & SAVE



**\$299**

**+ RECEIVE 15% OFF ANY  
ADDITIONAL INK  
PURCHASED WITH PRINTER**



**PRINTER + 4 TONERS ONLY ~~\$488~~ \$399** **SAVE \$89!**  
*Only while supplies last*



**CANON L190**

**OR**



**CANON MF236n**

**+**



**TONER**



**LABEL PRINTERS AND LABEL TAPES  
UP TO 25% VOLUME DISCOUNTS**



**OEM AND REMANUFACTURED TONER  
FOR MOST PRINTER BRANDS**

Call 330-674-2251  
Fax 330-674-0033  
sales@thinkinkllc.com



**Call or email us to  
request a free catalog**

**ThinkInk**  
Mt. Hope, Ohio

Let **light** in, naturally.



Meadow Sales – Rockville, IN

## OUR COMPLETE NATURAL DAYLIGHTING SYSTEM

Includes powder-coated metal or aluminum roofcurb. →

## CAPABILITIES & BENEFITS

- Reduces Energy Costs
- Improves Productivity & Morale
- Enhances Merchandise Appeal
- Evenly Distributes Light
- Comes Complete With All Materials
- No Leaks When Properly Installed
- Powder Coated To Match Roof Metal

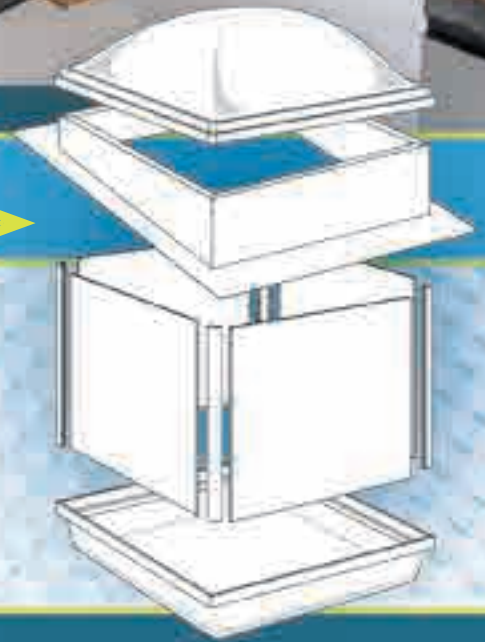

**DAY**  **STAR**™

High Performance Natural Lighting Systems

phone 618-426-1868 • fax 618-426-1888

CALL TODAY for design assistance, installation questions or to locate your nearest dealer.

**866-7-DAYSTAR WE TAKE PLEASURE IN YOUR CALL.**

14226 Highway 4 • Campbell Hill, Illinois 62916